

DIMENSIONAL DATA

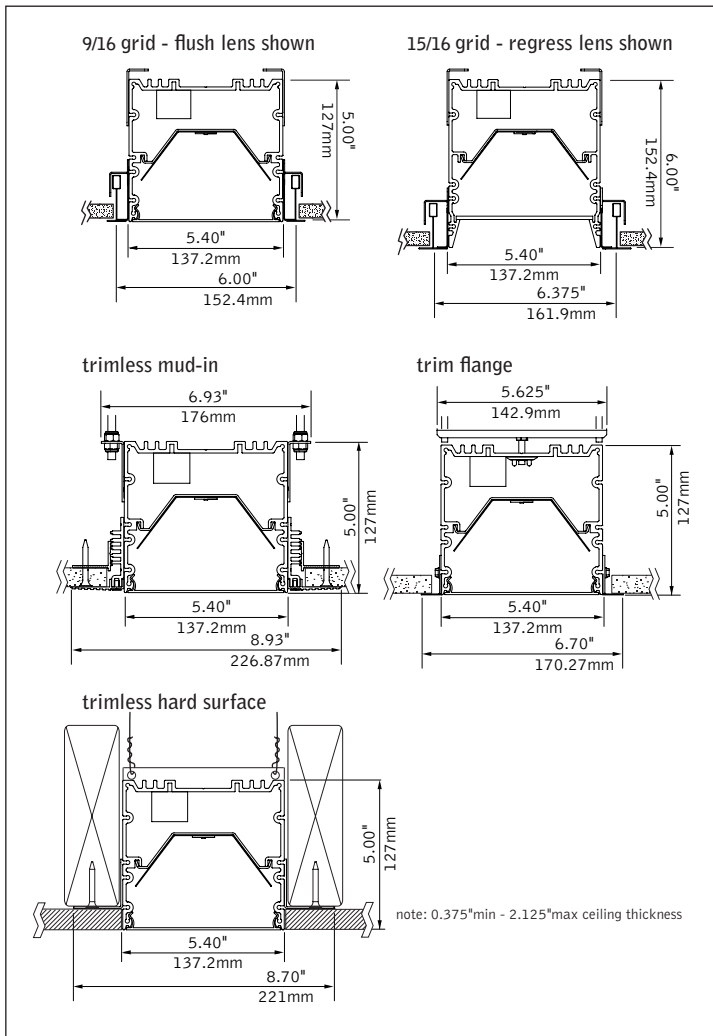

FEATURES

- Narrow extruded aluminum 6" aperture recessed slot LED.
- Integrates with ceiling or wall in a variety of mounting styles for a clean, unobtrusive aesthetic.
- Individual units and continuous runs in 1" increments.
- Frosted acrylic lens provides uninterrupted illumination, without pixels or shadows.
- LED position and lens material optimized to provide the perfect blend of high performance and visual comfort.
- Connected Solutions: Integrates with wired and wireless building lighting control systems.
- Preferred Light: Lighting for better color rendition and human preference.

PERFORMANCE

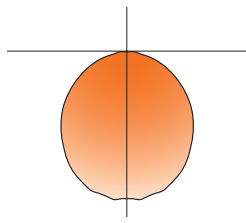

PRODUCT OVERVIEW

- Lumen Output: 1500-4000lm
- Wattage: 15-51W
- LPW: 78-104
- SDCM: 3

4' Flush Lens
625 Lumens per foot

Delivered Lumens: 2500lm

Total System Watts: 30W

Photometric performance is measured in accordance with IESNA LM-79. Visit focalpointlights.com for complete photometric data.

fixture:

project:

DETAILS

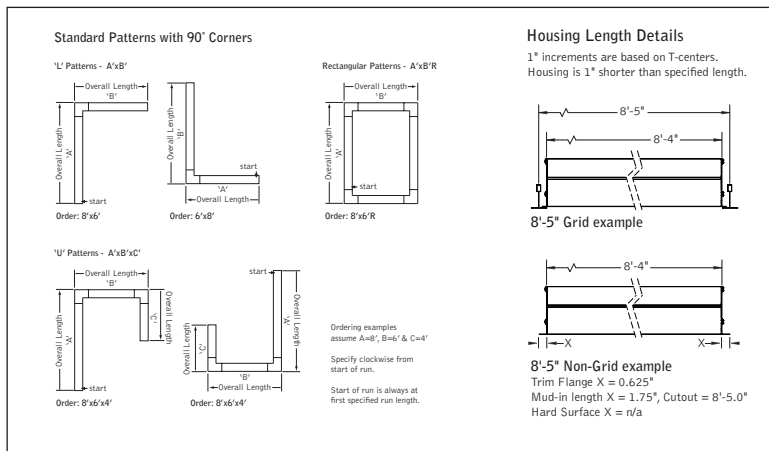

SPECIFICATIONS

LED System

Proprietary linear LED module incorporates premium LEDs on a robust platform to achieve excellent thermal management. LEDs are placed to promote a uniform appearance. Available in 2700K, 3000K, 3500K or 4000K with CRI>80 or CRI>90, 3SDCM. LED modules and drivers are replaceable from below.

Construction

One piece extruded aluminum housing. 20 Ga. steel end caps. Housing for new construction applications. XFW acceptable for use with wood, consult factory for Type IC availability. 2' unit weight: 18 lbs., 3' unit weight: 24 lbs., 4' unit weight: 30 lbs., 5' unit weight: 36 lbs.

Optic

Reflectors fabricated of 22 Ga. steel finished in High Reflectance White powder coat. Extruded acrylic lens .085" thick with satin finish, up to 8' continuous.

Electrical

Luminaires are pre-wired with factory installed branch circuit wiring and over-molded quick connects. Standard 120-277V constant current driver includes 0-10V analog dimming. Dimming range 100% to 10%. Power factor > .9.

Emergency Battery

Emergency output - 10 watts for 90 minutes. Maximum mounting height: 18.8ft. See EM/EC Guide for default locations and ordering details.

Labels

UL and cUL listed. Suitable for Dry or Damp Locations, indoor use only.

Finish

Polyster powder coat applied over a multi-stage pre-treatment.

Lumen Maintenance

Reported: L70 > 61,000 hours Calculated: L70 at > 350,000 hours
L90 > 61,000 hours L90 at > 90,000 hours
(Derived from EPA TM-21 calculator. Based on typical conditions, consult factory for additional data.)

Reliability

At Focal Point, our products are designed to stand the test of time. Each luminaire is engineered using superior components, manufactured with the utmost care and rigorously tested. Contact us for reliability data.

Warranty

LED system rated for operation in ambient environments up to 25°C. 5-year limited warranty.

4' PERFORMANCE CHART

Shielding	Lumens per Foot	Delivered Lumens	Tested System Watts	LPW
Flush Lens	375LF	1500	18	83
	625LF	2500	30	83
	875LF	3500	44	80
	1000LF	4000	51	78
Regressed Lens	375LF	1500	17	88
	625LF	2500	28	89
	875LF	3500	42	83
	1000LF	4000	48	83
Regressed High Performance	375LF	1500	15	100
	625LF	2500	24	104
	875LF	3500	36	97
	1000LF	4000	41	98

Based on 3500K, 80 CRI, 4' lengths. Lumen multipliers: Preferred Light = 0.65, 90+ CRI = 0.87. Lumen output may vary +/- 5%. Actual wattage may vary +/- 5%. Focal Point LLC reserves the right to change specifications for product improvement without notification.

ORDERING

Luminaire Series	FSM6L	FSM6L
Seem 6 LED		
Shielding		
Flush Satin Lens	FL	
Regressed Lens	SR	
(Ceiling applications only)		
Regressed High Performance Lens	SRXP	
(Ceiling applications only)		
Lumen Output		
375 Lumens per foot	375LF	
(Not available with LU5 & LH1 Drivers)		
625 Lumens per foot	625LF	
(4' minimum with LU5 & LH1 Drivers)		
875 Lumens per foot	875LF	
(3' minimum with LU5 & LH1 Drivers)		
1000 Lumens per foot	1000LF	
Color Temperature		
2700K, 80+ CRI or 90+ CRI	27K or 927K	
3000K, 80+ CRI or 90+ CRI	30K or 930K	
3500K, 80+ CRI or 90+ CRI	35K or 935K	
4000K, 80+ CRI or 90+ CRI	40K or 940K	
3500K, Preferred Light	P35K	
(Flush Lens only. 6" increments. Patterns not available.)		
Circuit		1C
Single Circuit	1C	
Voltage		UNV
UNV 120/277 Volt	UNV	
Control System & Dimming Level		
0-10V - 10% Dimming	LD1	
0-10V - 1% Dimming	L11	
Lutron Hi-Lume EcoSystem (LDE1) - 1% Dimming	LH1	
Lutron 5-Series EcoSystem (LDE5) - 5% Dimming	LU5	
DALI 1% Dimming	D11	
Acuity nLight - 1% Dimming	NLT1	
(Not available with CP. Grid only. 3' minimum length.)		
Enlighted Smart Sensor - 1% Dimming	ENL1	
(3' minimum length. Grid only.)		
Osram Connected Lighting Module for ENCELUM systems - 1% Dimming	CLM1	
(3' minimum length. Grid only. Compatible with Osram ENCELUM and ENCELUM EDGE systems only)		
Osram Connected Lighting Module for ZigBee Wireless Networks - 1% Dimming	CLMZ1	
(3' minimum length. Grid only. Not compatible with Osram ENCELUM systems)		
Wattstopper® DLM - 1% Dimming	DLM1	
(3' minimum length. Grid only)		
Ceiling Configurations		
Std. 15/16" Lay-in	G1	
Std. 15/16" Tegular	T1	
Std. 9/16" Lay-in	G2	
Std. 9/16" Tegular	T2	
9/16" Slot-tee Tegular	G3	
Tall 15/16" Lay-in	G4	
Tall 15/16" Tegular	T4	
Tall 9/16" Lay-in	G5	
Tall 9/16" Tegular	T5	
Node 9/16" Tegular	T6	
Trim Flange Drywall	TF	
(3' minimum with Lutron Drivers)		
Trim Flange Wood	TFW	
(3' minimum with Lutron Drivers)		
Mud-in Trimless, pre-set for 1/2" Drywall	XF1	
Mud-in Trimless, pre-set for 5/8" Drywall	XF2	
Mud-in Trimless, set thickness in field	XFF	
(Mounting equipment assembled in field)		
Non-Drywall Hard Surface Hard Surface, Wood	XFN	
Hard Surface, Wood	XFW	
(For TechZone™ compatible luminaires see Seem 6 TechZone)		
Factory Options		
Chicago Plenum	CP	
Emergency Circuit	_EC	
(4' minimum. 7' minimum with CLM1, CLMZ1, DLM1, ENL1 & NLT1.)		
Emergency Battery Pack	_EM	
(4' minimum. 7' minimum with CLM1, CLMZ1, DLM1, ENL1 & NLT1. See EM/EC Guide for default locations and ordering details.)		
6' New York City Flex Whip (120V)	FNY1	
6' New York City Flex Whip (277V)	FNY2	
6' Flex Whip	FW	
Finish		WH
Matte White Housing	WH	
Luminaire Length		ft in
Specify luminaire/row length in 1" increments	_ft_in	
(2' minimum, lengths are nominal 1" increments based on T-centers. Housing length is 1" shorter than specified. Leave blank for patterns. Smaller increments available, consult factory.)		
Pattern Options		
(3' minimum length)		
'L' pattern	A' x B'	
'U' pattern	A' x B' x C'	
Rectangular pattern	A' x B'R	
(Consult factory for other pattern options)		

QS 10 DAY* Options in orange qualify for the Quickship program. 4', 8' and run length in 4' increments. 400' total. Refer to Quickship Guide for complete details. For more information visit focalpointlights.com/reference or consult factory.

Focal Point provides flexibility in meeting the needs of each project by integrating with several building lighting control systems. A variety of sensors, drivers and other components can be specified that allow the luminaires to communicate with wired and wireless networks. All zoning can be digitally reconfigured through the application software. Daylight harvesting, occupancy sensing, integration with HVAC systems, and individual controls enable the monitoring and modulating of light levels and temperature in order to save energy, reduce costs and maximize occupants' comfort. All Connected Solutions luminaires require a compatible building control system.†

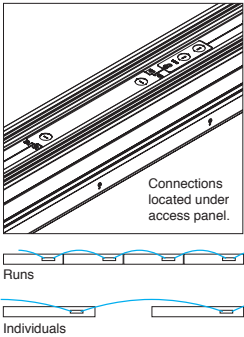

nLIGHT

nLight® provides a two-way wired digital lighting system allowing for on/off and dimming functionality, occupancy sensing, and multi-zone daylight harvesting.

Acuity nLight - 1% Dimming (NLT1)
Acuity Model #nEPS-60-IO

CAT-5 Cable provided by others. Serial labels will be provided on outside of luminaires and control unit.

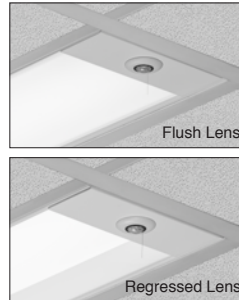

enlighted

Enlighted smart sensor allows for occupancy sensing, daylight harvesting, energy usage, temperature and light level control. Communicates wirelessly with the Enlighted network.

Enlighted Smart Sensor - 1% Dimming (ENL1)
Enlighted Model #SU-4E-01

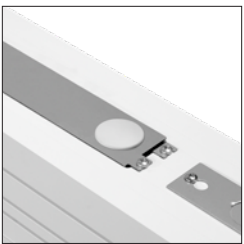

OSRAM

Connected Lighting Module (CLM) enables each luminaire to be independently controlled and configured. Communicates wirelessly with Daintree Networks®, Osram ENCELIUM®, Osram ENCELIUM EDGE™, and other networks using the ZigBee® HA communication protocol to allow for on/off and dimming functionality, occupancy sensing and multi-zone daylight harvesting.

Osram CLM - 1% Dimming (CLM1 & CLMZ1)
Osram Model #ZBHA-CLM DIM

Serial labels will be provided on outside of luminaires and control unit.

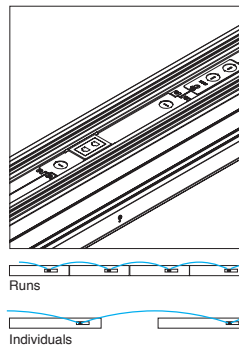

legrand® WATTSTOPPER®

A Digital Lighting Management (DLM) system that provides two-way wired communication between networked luminaires and control system to allow for on/off and dimming functionality, occupancy sensing and multi-zone daylight harvesting.

Wattstopper DLM - 1% Dimming (DLM1)
Wattstopper Model #LMFC-011

CAT-5 Cable provided by others. Serial labels will be provided on outside of luminaires and control unit.

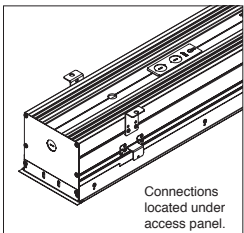

LUTRON®

A two-way digital network that enables on/off and dimming functionality, occupancy sensing, and multi-zone daylight harvesting working with Quantum®, Energi Savr Node™, and Energi TriPak™ using EcoSystem® communication protocol.

Lutron Hi-Lume EcoSystem - 1% Dimming (LH1)
Lutron Model #LDE1
Lutron 5-Series EcoSystem - 5% Dimming (LU5)
Lutron Model #LDE5

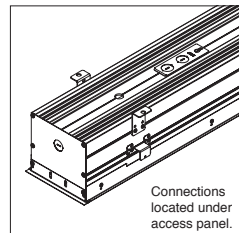

CRESTRON®

A two-way digital network that enables on/off and dimming functionality, occupancy sensing, and multi-zone daylight harvesting. Communicates with Züm wireless and SpaceBuilder working with Züm hub scheduling or FUSION management.

DALI - 1% Dimming (D11)
0-10V - 1% Dimming (L11)

Note: 0-10V is not a digital network but is compatible with Crestron Züm™ system.

CONNECTED SOLUTIONS DETAILS

Connected Solution	Model #	Protocol	Compatible Networks*	Occupancy	Daylight	Temperature Reporting	Communication to Luminaire	Drivers
Acuity nLight (NLT1)	nEPS-60-IO**	nLight	nLight	Enabled	Enabled	No	Wired	eldoLED ECOdrive , eldoLED SOLOdrive
Crestron (D11, L11)	Specified Driver	DALI 0-10V	Crestron Züm Wireless & SpaceBuilder	Enabled	Enabled	No	Wired	eldoLED ECOdrive (DALI) , Philips Xitanium (0-10V)
Enlighted Smart Sensor (ENL1)	SU-4E-01**	Enlighted RF	Enlighted	Integrated	Integrated	Yes	Wireless	Philips SimpleSet , Osram Optotronic
Legrand Wattstopper DLM (DLM1)	LMFC-011**	DLM	DLM	Enabled	Enabled	No	Wired	Philips SimpleSet , Osram Optotronic
Lutron EcoSystem (LH1 & LU5)	LDE1**, LDE5**	EcoSystem	Quantum, Energi Savr Node, Energi TriPak	Enabled	Enabled	No	Wired	Lutron Hi-Lume Lutron 5-Series
Osram CLM for ENCELIUM systems (CLM1)	ZBHA-CLM**	ZigBee HA	Osram ENCELIUM & ENCELIUM EDGE	Enabled	Enabled	No	Wireless	Osram Optotronic
Osram CLM for ZigBee Wireless Networks (CLMZ1)	ZBHA-CLM**	ZigBee HA	Daintree Networks & open ZigBee Networks	Enabled	Enabled	No	Wireless	Osram Optotronic

*Not all compatible networks may be listed. **For performance data and additional control system details please visit the connected solutions manufacturer websites. Primary drivers are listed in bold. To specify a particular driver please consult factory. †Controls systems supplied by others.

Seem® EM/EC Guide

FSM1, FSM1S, FSM1W, FSM2L-FL, FSM2L-FL2, FSM2LS, FSM2LW, FSM4L-FL/SR/SRXP, FSM4L-FL2, FSM4LS, FSM4LW, FSM4LP, FSM6L-FL/SR/SRXP*



DEFAULT LOCATIONS

- By default, EM/EC are located at the end (last section) of a run when one EM/EC location is specified, and at the start and end when two locations are specified.
- EM/EC illuminate entire sections from 4' to 8' in length.
- Feed location is at start of run. All EC's are fed individually at the end of each fixture segment.

1 EM/EC – END OF RUN

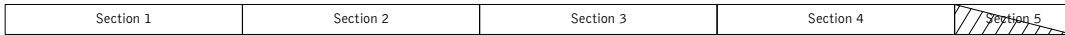

Ordering example: FSM4L-FL... **1EM-WH-36ft**

2 EM/EC – START & END OF RUN



Ordering example: FSM4L-FL... **2EM-WH-36ft**

ALTERNATE LOCATIONS AND QUANTITIES

- If more than two locations are required, or specific locations within run need to be specified, indicate in the ordering string.

ONE EM IN 3RD SECTION

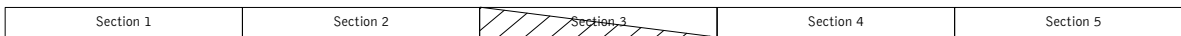

Ordering example: FSM4L-FL... **1EM-3-WH-40ft**

THREE EM IN 1ST, 3RD AND 6TH SECTIONS



Ordering example: FSM4L-FL... **3EM-1-3-6-WH-48ft**

CUSTOM LENGTHS

- If partial illumination of emergency section is required, indicate quantity in ordering string and partial illumination in Order Notes. Drawing required.
- Longer lead times may apply.

Run length (ft)	Housing Configuration Section Lengths
9	5 + 4
10	6 + 4
11	7 + 4
12	8 + 4
13	8 + 5
14	8 + 6
15	8 + 7
16	8 + 8
17	8 + 5 + 4
18	8 + 6 + 4
19	8 + 7 + 4
20	8 + 8 + 4
21	8 + 8 + 5
22	8 + 8 + 6
23	8 + 8 + 7
24	8 + 8 + 8
25	8 + 8 + 5 + 4
26	8 + 8 + 6 + 4
27	8 + 8 + 7 + 4

Run length (ft)	Housing Configuration Section Lengths
28	8 + 8 + 8 + 4
29	8 + 8 + 8 + 5
30	8 + 8 + 8 + 6
31	8 + 8 + 8 + 7
32	8 + 8 + 8 + 8
33	8 + 8 + 8 + 5 + 4
34	8 + 8 + 8 + 6 + 4
35	8 + 8 + 8 + 7 + 4
36	8 + 8 + 8 + 8 + 4
37	8 + 8 + 8 + 8 + 5
38	8 + 8 + 8 + 8 + 6
39	8 + 8 + 8 + 8 + 7
40	8 + 8 + 8 + 8 + 8
41	8 + 8 + 8 + 8 + 5 + 4
42	8 + 8 + 8 + 8 + 6 + 4
43	8 + 8 + 8 + 8 + 7 + 4
44	8 + 8 + 8 + 8 + 8 + 4
45	8 + 8 + 8 + 8 + 8 + 5
46	8 + 8 + 8 + 8 + 8 + 6
47	8 + 8 + 8 + 8 + 8 + 7
48	8 + 8 + 8 + 8 + 8 + 8

Standard run configurations, consult factory for custom configurations.

*Recessed and suspended only. Does not include direct/indirect, pop-down lens or asymmetric options.