



recessed companion



wall to ceiling companion



wall mount companion



end detail



perimeter companion

DIMENSIONAL DATA

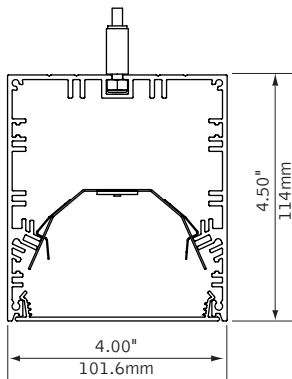

MOUNTING INFORMATION

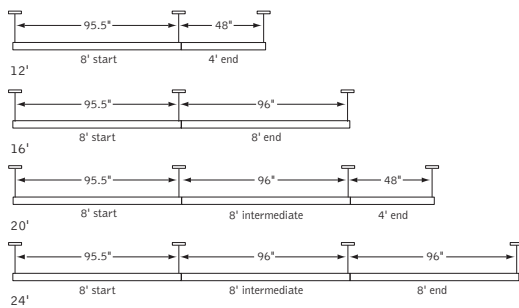

Consult factory for additional row length information.

FEATURES

Narrow extruded aluminum 4" linear direct LED.

Individual units and continuous runs in 1' increments.

Frosted acrylic lens provides uninterrupted illumination, without pixels or shadows.

LED position and lens material optimized to provide the perfect blend of high performance and visual comfort.

Choice of output levels to meet a wide variety of application needs.

Connected Solutions: Integrates with wired and wireless building lighting control systems.

Preferred Light: Lighting for better color rendition and human preference.

PERFORMANCE

PRODUCT OVERVIEW

Lumen Output: 1690-4240lm

Wattage: 16-42W

LPW: 101-109

SDCM: 3

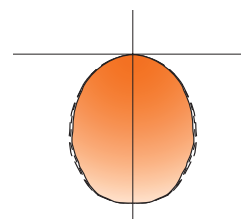

4' Flush Lens
Nominal output:
375 Lumens per foot

Delivered Lumens: 1690lm

Total System Watts: 16W



Photometric performance is measured in accordance with IESNA LM-79.
Visit focalpointlights.com for complete photometric data.

DETAILS

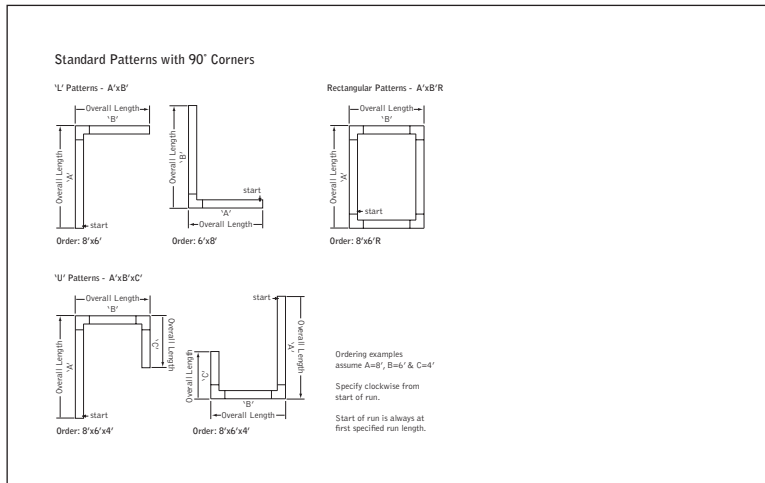

SPECIFICATIONS

LED System

Proprietary linear LED module incorporates premium LEDs on a robust platform to achieve excellent thermal management. LEDs are placed to promote a uniform appearance. Available in 2700K, 3000K, 3500K or 4000K with CRI>80 or CRI>90, 3SDCM. LED modules and drivers are replaceable from below.

Construction

One piece extruded aluminum housing. Die cast aluminum end caps. 2' unit weight: 10 lbs., 3' unit weight: 14 lbs., 4' unit weight: 18 lbs., 5' unit weight: 22 lbs.

Optic

Reflectors fabricated of 22 Ga. steel finished in High Reflectance White powder coat. Extruded acrylic lens .085" thick with satin finish, up to 8' continuous.

Electrical

Luminaires are pre-wired with factory installed branch circuit wiring and over-molded quick connects. Standard 120-277V constant current driver includes 0-10V analog dimming. Dimming range 100% to 10%. Power factor > .9.

Emergency

Output - 10 watts for 90 minutes. Maximum mounting height: 19.2ft. See EM/EC Guide for default locations and ordering details.

Labels

UL and cUL listed. Suitable for Dry or Damp Locations, indoor use only.

Finish

Polyester powder coat applied over a multi-stage pre-treatment.

Lumen Maintenance

Reported: L70 > 61,000 hours Calculated: L70 at > 287,000 hours
 L90 > 61,000 hours L90 at > 74,000 hours
 (Derived from EPA TM-21 calculator. Based on typical conditions, consult factory for additional data.)

Reliability

At Focal Point, our products are designed to stand the test of time. Each luminaire is engineered using superior components, manufactured with the utmost care and rigorously tested. Contact us for reliability data.

Warranty

LED system rated for operation in ambient environments up to 25°C. 5-year limited warranty.

4' PERFORMANCE CHART

Shielding	Lumens per Foot	Delivered Lumens	Tested System Watts	LPW
Flush Lens	375LF	1690	16	106
	625LF	2810	26	109
	875LF	3860	37	105
	1000LF	4240	42	101

Based on 3500K, 80 CRI, 4' lengths. Lumen multipliers: Preferred Light = 0.65, 90+ CRI = 0.87. Lumen output may vary +/- 5%. Actual wattage may vary +/- 5%.

ORDERING

Luminaire Series	Seem 4 LED	FSM4LS	FSM4LS
Shielding	Flush Satin Lens	FL	FL
Lumen Output	275 Lumens per foot <small>(Not available with Lutron Drivers.)</small>	275LF	
	375 Lumens per foot <small>(Not available with LU5 & LH1 Drivers)</small>	375LF	
	625 Lumens per foot <small>(3' minimum with LU5 & LH1 Drivers)</small>	625LF	
	875 Lumens per foot	875LF	
	1000 Lumens per foot	1000LF	
Color Temperature	2700K, 80+ CRI or 90+ CRI	27K or 927K	
	3000K, 80+ CRI or 90+ CRI	30K or 930K	
	3500K, 80+ CRI or 90+ CRI	35K or 935K	
	4000K, 80+ CRI or 90+ CRI	40K or 940K	
	3500K, Preferred Light <small>(Patterns not available.)</small>	P35K	
Circuit	Single Circuit	1C	1C
Voltage	UNV 120/277 Volt	UNV	UNV
Control System & Dimming Level	0-10V - 10% Dimming	LD1	
	0-10V - 1% Dimming	L11	
	Lutron Hi-Lume EcoSystem (LDE1) - 1% Dimming	LH1	
	Lutron 5-Series EcoSystem (LDE5) - 5% Dimming	LU5	
	DALI 1% Dimming	D11	
	Acuity nLight - 1% Dimming <small>(3' minimum length.)</small>	NLT1	
	Enlighted Smart Sensor - 1% Dimming <small>(3' minimum length.)</small>	ENL1	
	Osram Connected Lighting Module for ENCELIUM systems - 1% Dimming <small>(3' minimum length. Compatible with Osram ENCELIUM and ENCELIUM EDGE systems only)</small>	CLM1	
	Osram Connected Lighting Module for ZigBee Wireless Networks - 1% Dimming <small>(3' minimum length. Not compatible with Osram ENCELIUM systems)</small>	CLMZ1	
	Wattstopper DLM - 1% Dimming <small>(3' minimum length.)</small>	DLM1	
Mounting	24" Cable Suspension	C24	
	48" Cable Suspension	C48	
	96" Cable Suspension <small>(Add "P" for Chicago plenum. Eg: CP12) (Specify one of the following in place of "C" J - for 2' canopies at non-feed locations. CS - for sloped ceiling applications.)</small>	C96	
	Surface Mount <small>(Not available with DLM1 or NLT1)</small>	SM	
Factory Options	Emergency Circuit <small>(4' minimum. 7' minimum with CLM1, CLMZ1, DLM1, ENL1 & NLT1.)</small>	_EC	
	Emergency Battery Pack <small>(4' minimum. 7' minimum with CLM1, CLMZ1, DLM1, ENL1 & NLT1. See EM/EC Guide for default locations and ordering details.)</small>	_EM	
Finish	Titanium Silver	TS	
	Matte White Housing	WH	
Luminaire Length	Specify luminaire/row length in 1' increments <small>(Smaller increments available. Consult factory for details.)</small>	X'	
Pattern Options	'L' pattern	A' x B'	
	'U' pattern	A' x B' x C'	
	Rectangular pattern	A' x B'R	

(Consult factory for other pattern options)

Focal Point provides flexibility in meeting the needs of each project by integrating with several building lighting control systems. A variety of sensors, drivers and other components can be specified that allow the luminaires to communicate with wired and wireless networks. All zoning can be digitally reconfigured through the application software. Daylight harvesting, occupancy sensing, integration with HVAC systems, and individual controls enable the monitoring and modulating of light levels and temperature in order to save energy, reduce costs and maximize occupants' comfort. All Connected Solutions luminaires require a compatible building control system.†

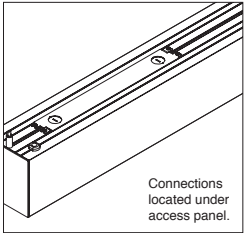

nLight® provides a two-way wired digital lighting system allowing for on/off and dimming functionality, occupancy sensing, and multi-zone daylight harvesting.

Acuity nLight - 1% Dimming (NLT1)
Acuity Model #nEPS-60-IO

CAT-5 Cable provided between segments of a run. CAT-5 Cable provided by others at start of run. Serial labels will be provided on outside of luminaires and control unit.



Enlighted smart sensor allows for occupancy sensing, daylight harvesting, energy usage, temperature and light level control. Communicates wirelessly with the Enlighted network.

Enlighted Smart Sensor - 1% Dimming (ENL1)
Enlighted Model #SU-4E-01

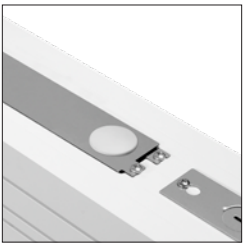

Connected Lighting Module (CLM) enables each luminaire to be independently controlled and configured. Communicates wirelessly with Daintree Networks®, Osram ENCELIUM®, Osram ENCELIUM EDGE™, and other networks using the ZigBee® HA communication protocol to allow for on/off and dimming functionality, occupancy sensing and multi-zone daylight harvesting.

Osram CLM - 1% Dimming (CLM1 & CLMZ1)
Osram Model #ZBHA-CLM DIM

Serial labels will be provided on outside of luminaires and control unit.

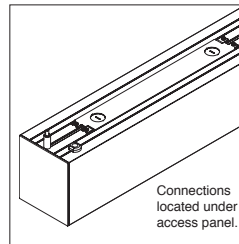

A Digital Lighting Management (DLM) system that provides two-way wired communication between networked luminaires and control system to allow for on/off and dimming functionality, occupancy sensing and multi-zone daylight harvesting.

Wattstopper DLM - 1% Dimming (DLM1)
Wattstopper Model #LMFC-011

Segment Network Wire provided between segments of a run. Segment Network Wire provided by others at start of run. Serial labels will be provided on outside of luminaires and control unit.

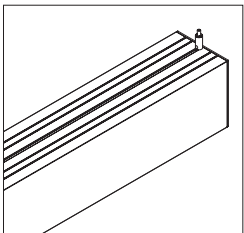

A two-way digital network that enables on/off and dimming functionality, occupancy sensing, and multi-zone daylight harvesting working with Quantum®, Energi Savr Node™, and Energi TriPak® using EcoSystem® communication protocol.

Lutron Hi-Lume EcoSystem - 1% Dimming (LH1)
Lutron Model #LDE1
Lutron 5-Series EcoSystem - 5% Dimming (LU5)
Lutron Model #LDE5

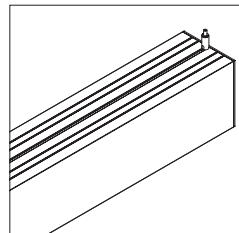

A two-way digital network that enables on/off and dimming functionality, occupancy sensing, and multi-zone daylight harvesting. Communicates with Züm wireless and SpaceBuilder working with Züm hub scheduling or FUSION management.

DALI - 1% Dimming (D11)
0-10V - 1% Dimming (L11)

Note: 0-10V is not a digital network but is compatible with Creston Züm™ system.

CONNECTED SOLUTIONS DETAILS

Connected Solution	Model #	Protocol	Compatible Networks*	Occupancy	Daylight	Temperature Reporting	Communication to Luminaire	Drivers
Acuity nLight (NLT1)	nEPS-60-IO**	nLight	nLight	Enabled	Enabled	No	Wired	eldoLED ECOdrive , eldoLED SOLOdrive
Crestron (D11, L11)	Specified Driver	DALI 0-10V	Crestron Züm Wireless & SpaceBuilder	Enabled	Enabled	No	Wired	eldoLED ECOdrive (DALI) , Philips Xitanium (0-10V)
Enlighted Smart Sensor (ENL1)	SU-4E-01**	Enlighted RF	Enlighted	Integrated	Integrated	Yes	Wireless	Philips SimpleSet , Osram Optotronic
Legrand Wattstopper DLM (DLM1)	LMFC-011**	DLM	DLM	Enabled	Enabled	No	Wired	Philips SimpleSet , Osram Optotronic
Lutron EcoSystem (LH1 & LU5)	LDE1**, LDE5**	EcoSystem	Quantum, Energi Savr Node, Energi TriPak	Enabled	Enabled	No	Wired	Lutron Hi-Lume Lutron 5-Series
Osram CLM for ENCELIUM systems (CLM1)	ZBHA-CLM**	ZigBee HA	Osram ENCELIUM & ENCELIUM EDGE	Enabled	Enabled	No	Wireless	Osram Optotronic
Osram CLM for ZigBee Wireless Networks (CLMZ1)	ZBHA-CLM**	ZigBee HA	Daintree Networks & open ZigBee Networks	Enabled	Enabled	No	Wireless	Osram Optotronic

*Not all compatible networks may be listed. **For performance data and additional control system details please visit the connected solutions manufacturer websites. Primary drivers are listed in bold. To specify a particular driver please consult factory. †Controls systems supplied by others.

Seem® EM/EC Guide

FSM1, FSM1S, FSM1W, FSM2L-FL, FSM2L-FL2, FSM2LS, FSM2LW, FSM4L-FL/SR/SRXP, FSM4L-FL2, FSM4LS, FSM4LW, FSM4LP, FSM6L-FL/SR/SRXP*



DEFAULT LOCATIONS

- By default, EM/EC are located at the end (last section) of a run when one EM/EC location is specified, and at the start and end when two locations are specified.
- EM/EC illuminate entire sections from 4' to 8' in length.
- Feed location is at start of run. All EC's are fed individually at the end of each fixture segment.

1 EM/EC – END OF RUN

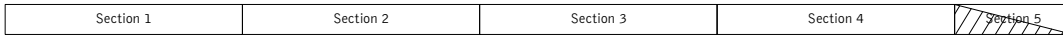

Ordering example: FSM4L-FL... **1EM-WH-36ft**

2 EM/EC – START & END OF RUN



Ordering example: FSM4L-FL... **2EM-WH-36ft**

ALTERNATE LOCATIONS AND QUANTITIES

- If more than two locations are required, or specific locations within run need to be specified, indicate in the ordering string.

ONE EM IN 3RD SECTION

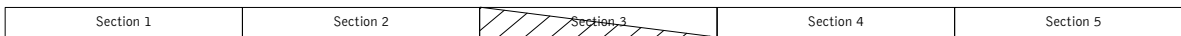

Ordering example: FSM4L-FL... **1EM-3-WH-40ft**

THREE EM IN 1ST, 3RD AND 6TH SECTIONS



Ordering example: FSM4L-FL... **3EM-1-3-6-WH-48ft**

CUSTOM LENGTHS

- If partial illumination of emergency section is required, indicate quantity in ordering string and partial illumination in Order Notes. Drawing required.
- Longer lead times may apply.

Run length (ft)	Housing Configuration Section Lengths
9	5 + 4
10	6 + 4
11	7 + 4
12	8 + 4
13	8 + 5
14	8 + 6
15	8 + 7
16	8 + 8
17	8 + 5 + 4
18	8 + 6 + 4
19	8 + 7 + 4
20	8 + 8 + 4
21	8 + 8 + 5
22	8 + 8 + 6
23	8 + 8 + 7
24	8 + 8 + 8
25	8 + 8 + 5 + 4
26	8 + 8 + 6 + 4
27	8 + 8 + 7 + 4

Run length (ft)	Housing Configuration Section Lengths
28	8 + 8 + 8 + 4
29	8 + 8 + 8 + 5
30	8 + 8 + 8 + 6
31	8 + 8 + 8 + 7
32	8 + 8 + 8 + 8
33	8 + 8 + 8 + 5 + 4
34	8 + 8 + 8 + 6 + 4
35	8 + 8 + 8 + 7 + 4
36	8 + 8 + 8 + 8 + 4
37	8 + 8 + 8 + 8 + 5
38	8 + 8 + 8 + 8 + 6
39	8 + 8 + 8 + 8 + 7
40	8 + 8 + 8 + 8 + 8
41	8 + 8 + 8 + 8 + 5 + 4
42	8 + 8 + 8 + 8 + 6 + 4
43	8 + 8 + 8 + 8 + 7 + 4
44	8 + 8 + 8 + 8 + 8 + 4
45	8 + 8 + 8 + 8 + 8 + 5
46	8 + 8 + 8 + 8 + 8 + 6
47	8 + 8 + 8 + 8 + 8 + 7
48	8 + 8 + 8 + 8 + 8 + 8

Standard run configurations, consult factory for custom configurations.

*Recessed and suspended only. Does not include direct/indirect, pop-down lens or asymmetric options.