

flush lens
top & bottom

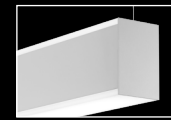

pop-up lens &
pop-down lens

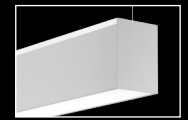

pop-up lens &
flush lens bottom



end detail

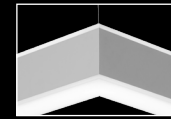

single point corner
suspension



linear direct only
companion



wall to ceiling
corner companion

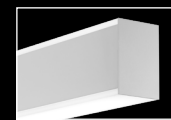

wall mount
companion



recessed
companion

DIMENSIONAL DATA

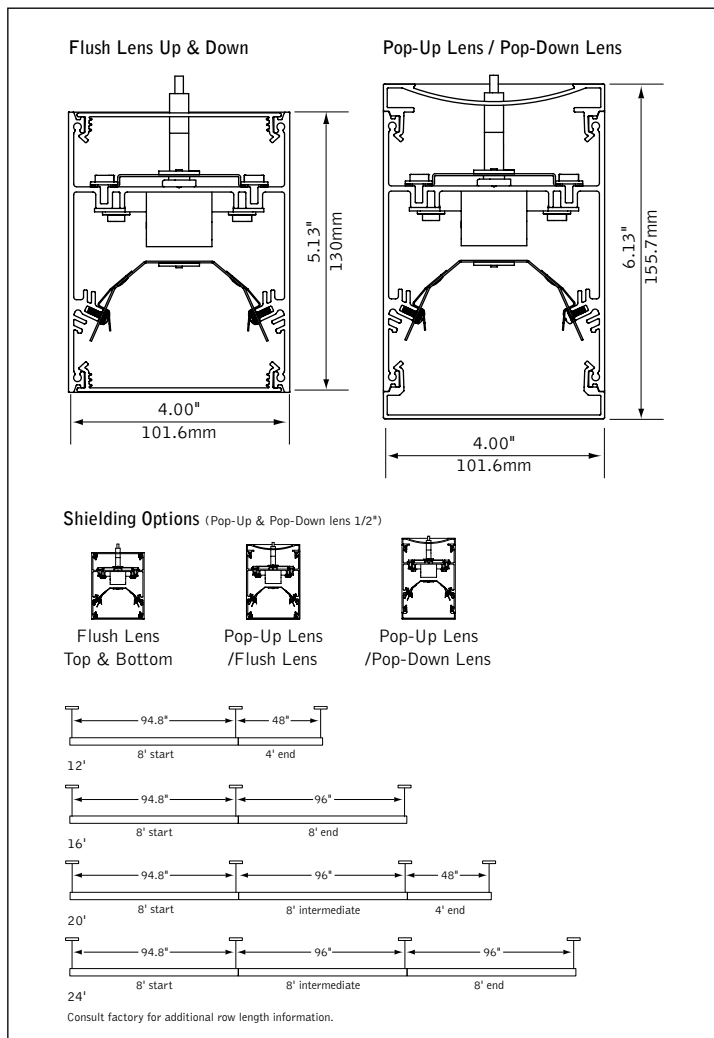

FEATURES

Narrow extruded aluminum 4" linear direct/indirect LED with Pop-lens options.

Features Right Light lumen levels allowing lumen and wattage design flexibility.

Individual units and continuous runs in 1' increments.

Frosted acrylic lenses provide uninterrupted illumination, without pixels or shadows.

LED position and lens material optimized to provide the perfect blend of high performance and visual comfort.

Choice of output levels and light distributions to meet a wide variety of application needs.

PERFORMANCE

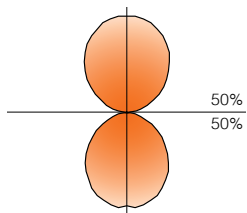

PRODUCT OVERVIEW

Lumen Output: 2200 - 7500

Wattage: 24 - 86W

LPW: 86 - 96

Distribution: 20/80 - 80/20

SDCM: 3

Lumen Maintenance: L90 @ 106,000hrs

4' Pop-up Lens Top / Flush Lens Bottom
375 Lm/ft Up & Down

Delivered Lumens: 3000lm

Total System Watts: 33W

Photometric performance is measured in accordance with IESNA LM-79. Visit focalpointlights.com for complete photometric data.

DETAILS

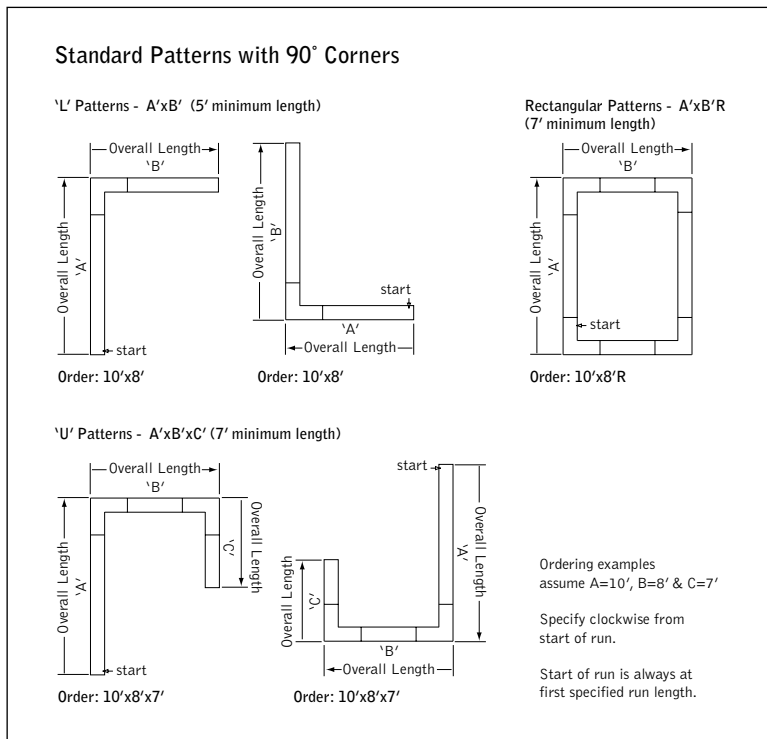

SPECIFICATIONS

LED System

Proprietary linear LED module incorporates premium LEDs on a robust platform to achieve excellent thermal management. LEDs are placed to promote a uniform appearance. Available in 3000K, 3500K or 4000K with CRI>80, 3SDCM. LED modules and drivers are replaceable from below.

Construction

One piece extruded aluminum housing. Die cast aluminum end caps. 3' unit weight: 14.75lbs., 4' unit weight: 19lbs., 5' unit weight: 25lbs.

Optic

Reflectors fabricated of 22 Ga. steel finished in High Reflectance White powder coat. Extruded acrylic lens .085" thick with satin finish, up to 8' continuous.

Electrical

Luminaires are pre-wired with factory installed branch circuit wiring and over-molded quick connects. Standard 120-277V constant current driver includes 0-10V analog dimming. Dimming range 100% to 10%. Power factor > .9.

Emergency Battery

Bodine BSL310LP. Emergency output - 10 watts for 90 minutes. Maximum mounting height: 15.54ft

Labels

UL and cUL listed. Suitable for Dry or Damp Locations, indoor use only.

Finish

Polyester powder coat applied over a multi-stage pre-treatment.

Lumen Maintenance

Calculated: L90 at 106,000 hours Reported: L90 at >61,000 hours
 Derived from EPA TM-21 calculator

Warranty

LED system rated for operation in ambient environments up to 25°C. 5 year limited warranty.

4' PERFORMANCE CHART

See page 3

ORDERING

Luminaire Series	FSM4BS
Seem 4 Direct/Indirect LED	FSM4BS
Shielding	
Flush Lens Top / Flush Lens Bottom	FLFL
Pop-Up Lens/ Flush Lens Bottom	PUFL
Pop-Up Lens/ Pop-Down Lens	PUPD
Direct Distribution	
(See driver compatibility chart on page 3)	
275 Lumens per foot	275DN
375 Lumens per foot	375DN
625 Lumens per foot	625DN
875 Lumens per foot	875DN
1000 Lumens per foot	1000DN
(Not available with 1000UP Indirect)	
Indirect Distribution	
(See driver compatibility chart on page 3)	
275 Lumens per foot	275UP
375 Lumens per foot	375UP
625 Lumens per foot	625UP
875 Lumens per foot	875UP
1000 Lumens per foot	1000UP
(Not available with 1000DN direct)	
Color Temperature	
3000K	30K
3500K	35K
4000K	40K
Circuit	
Single Circuit	1C
Dual Circuit	2C
(Multiple feeds required for 0-10V drivers)	
Voltage	
120 Volt	120
277 Volt	277
UNV Volt	UNV
(Cannot be specified with EM option)	
Driver	
(See driver reference for driver quantities)	
0-10V - 10% Dimming	LD1
DALI - 1% Dimming	D11
(625 lumens per foot max.)	
Lutron A-Series -	L3D
1% EcoSystem Digital	
(875 lumens per foot max.	
Consult factory for 3-wire control)	
Lutron 5-Series -	LU5
5% EcoSystem Digital	
(Consult factory for availability.	
625 lumens per foot min.)	
Mounting	
24" Cable Suspension	C24
48" Cable Suspension	C48
96" Cable Suspension	C96
(Specify one of the following in place of "C"	
J - for 2" canopies at non-feed locations.	
CS - for sloped ceiling applications.)	
Factory Options	
Emergency Circuit*	EC
Emergency Battery Pack*	EM
(8' lengths or longer. 4' illuminated area.)	
Finish	
Titanium Silver	TS
Matte White Housing	WH
Luminaire Length	
(3' minimum length.	
Leave blank for patterns. Lengths are nominal)	
Specify luminaire/row	X'
length in 1' increments	
(Smaller increments available. Consult factory.)	
Pattern Options	
'L' pattern	A' x B'
(5' minimum length)	
'U' pattern	A' x B' x C'
(7' minimum length)	
Rectangular pattern	A' x B'R
(7' minimum length)	
(Consult factory for other pattern options)	

DRIVER COMPATIBILITY CHART

Driver Description	Driver Code	Lumens per foot				
		275	375	625	875	1000
0-10V - 10% Dimming	LD1	✓	✓	✓	✓	✓
DALI - 1% Dimming	D11	✓	✓	✓		
Lutron A-Series - 1% EcoSystem Digital	L3D	✓	✓	✓	✓	
Lutron 5-Series - 5% EcoSystem Digital <small>(Consult factory for availability)</small>	LU5			✓	✓	✓

4' PERFORMANCE CHART

Direct Distribution	Indirect Distribution	Distribution % (Direct/Indirect)	Total Delivered Lumens	Tested System Watts	LPW
275DN	275UP	50/50	2200	24	92
	375UP	40/60	2600	28	93
	625UP	30/70	3600	40	90
	875UP	25/75	4600	52	88
	1000UP	20/80	5100	58	88
375DN	275UP	60/40	2600	28	93
	375UP	50/50	3000	33	91
	625UP	40/60	4000	44	91
	875UP	30/70	5000	56	89
	1000UP	25/75	5500	62	89
625DN	275UP	70/30	3600	40	90
	375UP	60/40	4000	44	91
	625UP	50/50	5000	53	94
	875UP	40/60	6000	63	95
	1000UP	35/65	6500	68	96
875DN	275UP	80/20	4600	52	88
	375UP	70/30	5000	56	89
	625UP	60/40	6000	68	88
	875UP	50/50	7000	80	88
	1000UP	45/55	7500	86	87
1000DN	275UP	80/20	5100	59	86
	375UP	70/30	5500	62	89
	625UP	60/40	6500	74	88
	875UP	55/45	7500	86	87

*Based on 3500k, 4' lengths. *Lumen output may vary +/- 5%. Actual wattage may vary +/- 5%. Pop-Up Lens/Pop-down lens lumen output may vary +/- 5%

Seem® 4

LED DIRECT/INDIRECT - FLUSH LENS/FLUSH LENS

FSM4BS-FLFL-375DN-375UP-35-K-1C-120-LD1

Filename: FSM4BSFLFL375DN375UP35K.IES
Test #: 18448.0

Lumens: 2862lm
System Watts: 33W
LPW: 87

CANDLEPOWER DISTRIBUTION

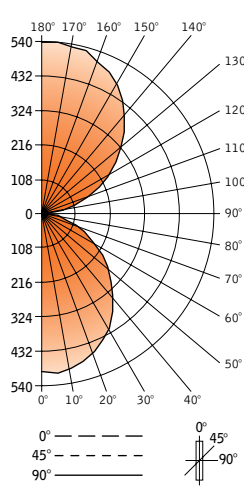

Vertical Angle	Horizontal Angle				
	0°	22.5°	45°	67.5°	90°
0°	498	498	498	498	498
5°	498	497	499	503	501
15°	472	479	480	482	482
25°	429	434	438	442	442
35°	371	376	379	380	388
45°	299	307	309	305	320
55°	227	225	27	227	233
65°	147	151	151	144	156
75°	77	76	76	76	81
85°	18	18	16	15	18
90°	5	8	8	7	5
95°	35	39	30	35	31
105°	115	111	104	102	107
115°	202	197	190	193	194
125°	284	288	275	281	282
135°	360	360	352	360	360
145°	434	429	432	433	440
155°	491	489	487	491	490
165°	529	525	528	528	529
175°	533	539	540	539	539
180°	537	537	537	537	537

LUMEN SUMMARY

Zone	Lumens	% Fixture
0-30°	381	13.3
0-90°	1294	45.2
90-180	1568	54.8
Total Luminaire 0-180°	2862	100.0

LUMINANCE DATA (CD/M²)

Vertical Angle	0°	45°	90°
45°	3887	4029	4170
55°	3638	3638	3747
65°	3193	3282	3400
75°	2752	2704	2897
85°	1863	1721	1863

Go to www.focalpointlights.com for additional photometric data.

Seem® 4

LED DIRECT/INDIRECT - POP-UP LENS/FLUSH LENS

FSM4BS-PUFL-375DN-375UP-35K-1C-120-LD1

Filename: FSM4BSPUFL375DN375UP35K.IES
Test #: 18980.0

Lumens: 2850lm
System Watts: 33W
LPW: 86

CANDLEPOWER DISTRIBUTION

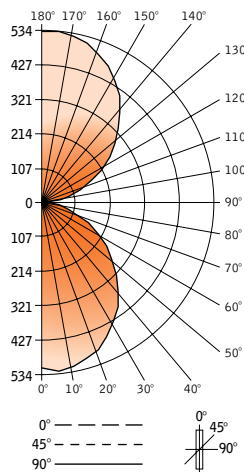

Vertical Angle	Horizontal Angle				
	0°	22.5°	45°	67.5°	90°
0°	516	516	516	516	516
5°	526	519	519	516	516
15°	502	496	496	494	494
25°	457	454	453	448	446
35°	397	393	395	388	386
45°	321	315	319	315	311
55°	236	234	241	241	241
65°	151	159	169	170	169
75°	78	86	98	107	110
85°	18	26	39	47	47
90°	3	13	20	26	29
95°	21	36	36	40	42
105°	78	96	107	103	103
115°	162	170	181	181	177
125°	248	245	247	249	247
135°	328	325	321	319	318
145°	406	400	393	388	388
155°	467	466	459	452	448
165°	512	512	502	499	495
175°	534	533	527	523	521
180°	533	533	533	533	533

LUMEN SUMMARY

Zone	Lumens	% Fixture
0-30°	397	13.9
0-90°	1409	49.5
90-180	1441	50.5
Total Luminaire 0-180°	2850	100.0

LUMINANCE DATA (CD/M²)

Vertical Angle	0°	45°	90°
45°	3209	1827	1553
55°	2794	1411	1203
65°	2276	1041	867
75°	1697	659	602
741	301		286

Go to www.focalpointlights.com for additional photometric data.

Seem® 4

LED DIRECT/INDIRECT - POP-UP LENS/POP-DOWN LENS

FSM4BS-PUPD-375DN-275UP-35K-1C-120-LD1

Filename: FSM4BSPUPD375DN275UP35K.IES
Test #: 18977.0

Lumens: 2533lm
System Watts: 28W
LPW: 90

CANDLEPOWER DISTRIBUTION

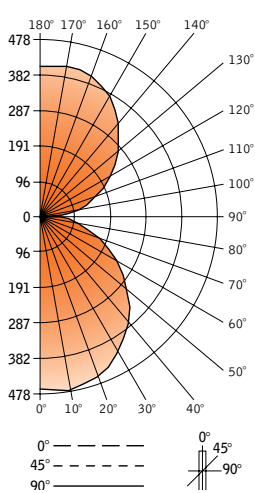

Vertical Angle	Horizontal Angle				
	0°	22.5°	45°	67.5°	90°
0°	472	472	472	472	472
5°	478	470	470	469	468
15°	457	452	452	452	448
25°	416	410	415	414	409
35°	357	356	362	362	357
45°	286	290	297	304	300
55°	213	221	234	240	239
65°	140	154	169	173	178
75°	70	90	100	109	112
85°	16	30	43	53	53
90°	0	13	25	33	38
95°	22	35	43	52	53
105°	69	88	99	104	97
115°	126	143	155	159	161
125°	188	201	208	218	217
135°	251	260	265	271	269
145°	313	319	320	319	319
155°	363	367	365	362	360
165°	397	399	396	393	393
175°	412	415	411	411	409
180°	414	414	414	414	414

LUMEN SUMMARY

Zone	Lumens	% Fixture
0-30°	362	14.3
0-90°	1334	52.7
90-180	1198	47.3
Total Luminaire 0-180°	2533	100.0

LUMINANCE DATA (CD/M²)

Vertical Angle	0°	45°	90°
45°	3097	2769	2671
55°	2819	2521	2422
65°	2479	2237	2169
75°	1962	1785	1780
85°	1160	1237	1265

Go to www.focalpointlights.com for additional photometric data.

Seem® 4

LED DIRECT/INDIRECT - POP-UP LENS/POP-DOWN LENS

FSM4BS-PUPD-375DN-375UP-35K-1C-120-LD1

Filename: FSM4BSPUPD375DN375UP35K.IES
Test #: 18972.0

Lumens: 2992lm
System Watts: 33W
LPW: 91

CANDLEPOWER DISTRIBUTION

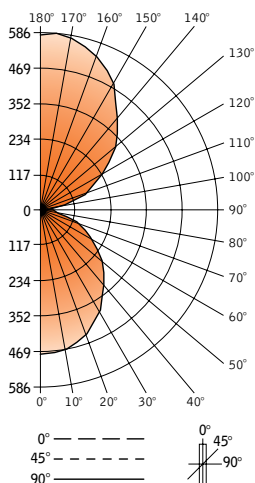

Vertical Angle	Horizontal Angle				
	0°	22.5°	45°	67.5°	90°
0°	477	477	477	477	477
5°	480	476	474	472	472
15°	459	455	453	453	449
25°	417	412	417	417	414
35°	356	355	365	363	365
45°	288	293	304	311	307
55°	215	224	243	247	250
65°	140	159	175	187	187
75°	70	88	109	119	122
85°	18	36	49	60	63
90°	1	17	31	41	48
95°	22	41	49	58	62
105°	95	118	123	132	130
115°	177	194	203	215	205
125°	271	275	285	293	288
135°	354	356	359	366	362
145°	439	435	439	439	439
155°	509	511	504	504	504
165°	558	557	551	550	550
175°	581	586	582	578	577
180°	581	581	581	581	581

LUMEN SUMMARY

Zone	Lumens	% Fixture
0-30°	365	12.2
0-90°	1366	45.6
90-180	1626	54.4
Total Luminaire 0-180°	2992	100.0

LUMINANCE DATA (CD/M²)

Vertical Angle	0°	45°	90°
45°	3114	2839	2735
55°	2840	2615	2530
65°	2484	2321	2274
75°	1966	1953	1939
85°	1322	1412	1506

Go to www.focalpointlights.com for additional photometric data.

Seem® 4

LED DIRECT/INDIRECT - POP-UP LENS/POP-DOWN LENS

FSM4BS-PUPD-375DN-625UP-35K-1C-120-LD1

Filename: FSM4BSPUPD375DN625UP35K.IES
Test #: 18973.0

Lumens: 4007lm
System Watts: 44W
LPW: 91

CANDLEPOWER DISTRIBUTION

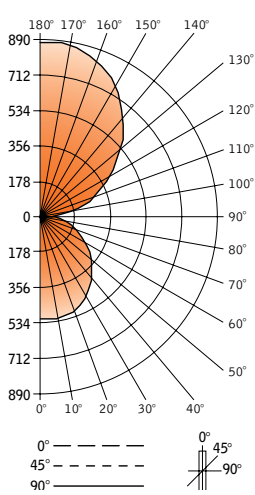

Vertical Angle	Horizontal Angle				
	0°	22.5°	45°	67.5°	90°
0°	525	525	525	525	525
5°	528	525	525	520	520
15°	508	506	505	502	502
25°	457	461	461	466	464
35°	385	396	404	407	410
45°	312	322	339	353	351
55°	239	250	280	289	290
65°	154	169	205	221	219
75°	81	107	134	148	152
85°	20	39	64	84	81
90°	3	25	45	59	64
95°	45	62	65	76	85
105°	140	169	180	180	188
115°	273	292	304	303	314
125°	409	416	433	424	426
135°	545	548	551	551	545
145°	662	668	671	660	665
155°	778	780	772	767	761
165°	850	821	845	842	839
175°	887	890	885	878	875
180°	888	888	888	888	888

LUMEN SUMMARY

Zone	Lumens	% Fixture
0-30°	405	10.1
0-90°	1551	38.7
90-180	2457	61.3
Total Luminaire 0-180°	4007	100.0

LUMINANCE DATA (CD/M²)

Vertical Angle	0°	45°	90°
45°	3381	3158	3126
55°	3166	3012	2944
65°	2723	2714	2669
75°	2264	2385	2419
85°	1463	1832	1927

Go to www.focalpointlights.com for additional photometric data.

Seem® 4

LED DIRECT/INDIRECT - POP-UP LENS/POP-DOWN LENS

FSM4BS-PUPD-375DN-875UP-35K-1C-120-LD1

Filename: FSM4BSPUPD375DN875UP35K.IES
Test #: 18974.0

Lumens: 4960lm
System Watts: 57W
LPW: 87

CANDLEPOWER DISTRIBUTION

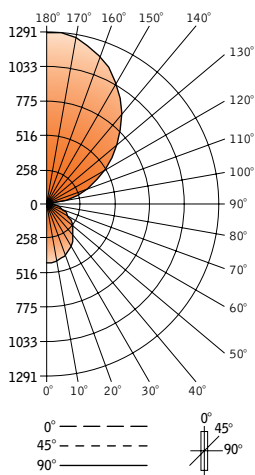

Vertical Angle	Horizontal Angle				
	0°	22.5°	45°	67.5°	90°
0°	454	454	454	454	454
5°	459	452	452	451	448
15°	437	732	436	436	435
25°	399	399	407	406	406
35°	339	345	361	368	373
45°	271	283	307	328	328
55°	203	225	263	272	281
65°	134	166	206	222	219
75°	69	108	136	155	155
85°	16	44	69	90	94
90°	7	29	56	78	82
95°	69	80	90	108	110
105°	215	245	251	256	259
115°	398	422	437	436	437
125°	597	605	609	612	606
135°	794	791	791	787	781
145°	971	967	963	948	944
155°	1125	1127	1113	1097	1098
165°	1231	1227	1222	1216	1210
175°	1289	1291	1282	1278	1268
180°	1287	1287	1287	1287	1287

LUMEN SUMMARY

Zone	Lumens	% Fixture
0-30°	352	7.1
0-90°	1435	28.9
90-180	3525	71.1
Total Luminaire 0-180°	4560	100.0

LUMINANCE DATA (CD/M²)

Vertical Angle	0°	45°	90°
45°	2935	2858	2923
55°	2686	2833	2844
65°	2364	2722	2673
75°	1947	2432	2467
85°	1185	1998	2243

Go to www.focalpointlights.com for additional photometric data.

Seem® 4

LED DIRECT/INDIRECT - POP-UP LENS/POP-DOWN LENS

FSM4BS-PUPD-375DN-1000UP-35K-1C-120-LD1

Filename: FSM4BSPUPD375DN1000UP35K.IES
Test #: 18974.0

Lumens: 5436lm
System Watts: 63W
LPW: 86

CANDLEPOWER DISTRIBUTION

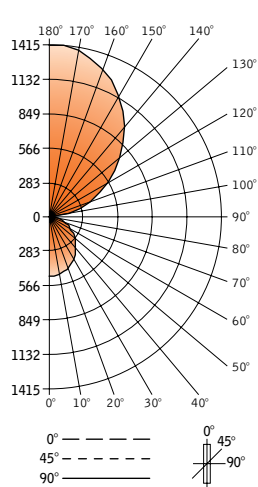

Vertical Angle	Horizontal Angle				
	0°	22.5°	45°	67.5°	90°
0°	497	497	497	497	497
5°	503	496	496	494	491
15°	479	473	478	478	476
25°	437	437	446	445	445
35°	372	378	396	403	409
45°	297	311	336	360	360
55°	222	246	288	299	308
65°	146	182	225	243	240
75°	76	118	149	170	170
85°	18	47	76	99	103
90°	7	31	61	85	90
95°	76	88	99	118	121
105°	236	269	275	281	283
115°	436	463	479	478	479
125°	654	663	667	670	664
135°	870	867	867	862	855
145°	1064	1060	1055	1039	1035
155°	1233	1235	1220	1202	1203
165°	1350	1345	1339	1333	1326
175°	1412	1415	1405	1400	1390
180°	1411	1411	1411	1411	1411

LUMEN SUMMARY

Zone	Lumens	% Fixture
0-30°	386	7.1
0-90°	1573	28.9
90-180	3863	71.1
Total Luminaire 0-180°	5436	100.0

LUMINANCE DATA (CD/M²)

Vertical Angle	Horizontal Angle		
	0°	45°	90°
45°	3217	3132	3204
55°	2944	3104	3117
65°	2590	2983	2929
75°	2134	2665	2704
85°	1298	2190	2458

Go to www.focalpointlights.com for additional photometric data.