

flush - solid diffuser



1" - solid diffuser



2"



3"



4"



5"



6"



7"

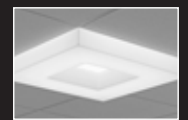

2" - 7"
hollow diffuser

DIMENSIONAL DATA

2" Drop -Solid Diffuser

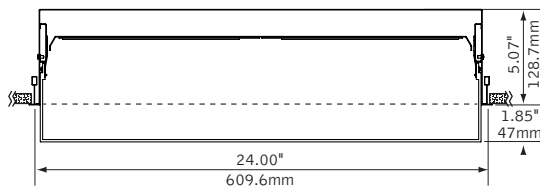

2" Drop -Hollow Diffuser

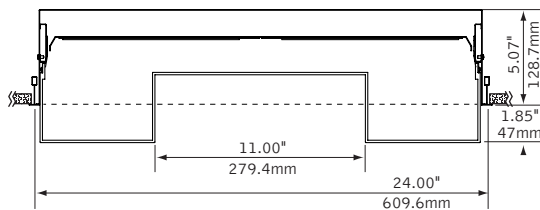

shielding options

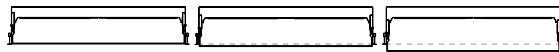

flush flat tee

flush tegular tile

1" drop

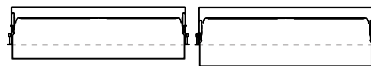

2" drop

3" drop

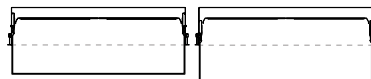

4" drop

5" drop

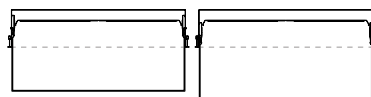

6" drop

7" drop

FEATURES

Architectural recessed LED luminaire with decorative flush or drop diffusers.

Square LED panels evenly backlight a formed frosted acrylic lens, creating a soft and pleasant glow.

The flush diffuser mimics a ceiling tile, aligning with flat or tegular panels.

Specify the Solid drop diffuser up to 7" down from the ceiling in 1" increments or the Hollow drop diffuser from 2" to 7" below the ceiling.

Hidden housing structure is invisible when installed in any ceiling.

Preferred Light: Lighting for better color rendition and human preference.

PERFORMANCE

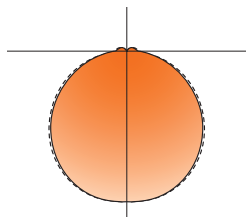

PRODUCT OVERVIEW

Lumen Output: 1000-4000lm

Wattage: 11-50W

LPW: 80-92

SDCM: 3

Reported Lumen L70 @ Maintenance: >60,000hrs

2000 Lumens

Delivered Lumens: 2000lm

Total System Watts: 83W

Photometric performance is measured in accordance with IESNA LM-79. Visit focalpointlights.com for complete photometric data.

fixture:

project:

MOUNTING INFORMATION

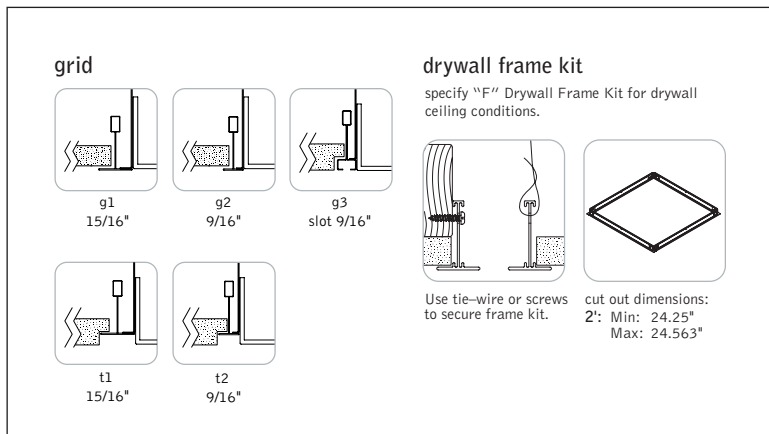

SPECIFICATIONS

LED System

Proprietary linear LED module incorporates premium LEDs on a robust platform to achieve excellent thermal management. LEDs are placed to promote a uniform appearance. Available in 3000K, 3500K or 4000K with CRI>80. 0-10V dimming driver standard. LED modules and drivers are replaceable from below. Color accuracy <3 SDCM.

Construction

One piece 20 Ga. steel housing. Bottom access 20 Ga. steel driver compartment. Positional brackets supplied as standard. Weight: 23 lbs.

Optic

.125" thick formed frosted acrylic diffuser.

Electrical

Standard 120-277V driver includes 0-10V analog dimming, 100% - 10% range. Power factor > .9. Optional EcoSystem dimming drivers from Lutron available.

Emergency Battery

Bodine BSL310-CAN. Emergency output—10 watts for 90 minutes. Maximum mounting height: 18ft

Labels

UL and cUL listed. Suitable for Dry or Damp Locations, indoor use only.

Finish

Polyester powder coat applied over a multi-stage pre-treatment.

Lumen Maintenance

Calculated: L70 at 128,000 hours Reported: L70 at >60,000 hours
Derived from EPA TM-21 calculator based on 10,000 hours of test data.

Reliability

At Focal Point, our products are designed to stand the test of time. Each luminaire is engineered using superior components, manufactured with the utmost care and rigorously tested. Contact us for reliability data.

Lifetime and warranty

LED system rated for operation in ambient environments up to 25°C. 5-year limited warranty.

PERFORMANCE CHART

Shielding	Delivered Lumens	System Watts	LPW
Flush	1000	11	92
	1500	18	84
	2000	24	83
	2500	30	83
	3000	37	82
	3500	44	80
	4000	50	80

*Based on 3000K. Lumen output may vary +/- 5%. Actual wattage may vary +/- 5%. Preferred Light lumen multiplier = 0.65.

ORDERING

Luminaire Series	FNVL	FNVL
Nivo	FNVL	
Nominal Size		22
2' x 2'	22	
Shielding		
0" - Flush with tile, Solid Diffuser	ACZ	
1" Drop - Solid Diffuser	AC1	
2" Drop - Solid Diffuser	AC2	
2" Drop - Hollow Diffuser	AX2	
3" Drop - Solid Diffuser	AC3	
3" Drop - Hollow Diffuser	AX3	
4" Drop - Solid Diffuser	AC4	
4" Drop - Hollow Diffuser	AX4	
5" Drop - Solid Diffuser	AC5	
5" Drop - Hollow Diffuser	AX5	
6" Drop - Solid Diffuser	AC6	
6" Drop - Hollow Diffuser	AX6	
7" Drop - Solid Diffuser	AC7	
7" Drop - Hollow Diffuser	AX7	
Lumen Output		
1000 Lumens	1000L	
1500 Lumens	1500L	
2000 Lumens	2000L	
2500 Lumens	2500L	
3000 Lumens	3000L	
3500 Lumens	3500L	
4000 Lumens	4000L	
Color Temperature		
3000K	30K	
3500K	35K	
4000K	40K	
3500K Preferred Light	P35K	
Circuit		1C
Single Circuit	1C	
Voltage		UNV
120/277 Volt	UNV	
Driver		
0-10V - 10% Dimming	LD1	
Lutron H-Series - 1% Dimming	LH1	
Lutron 5-Series - 5% EcoSystem Digital	LU5	
Mounting		
15/16" Layin	G1	
9/16" Layin	G2	
9/16" Slot Tee Tegular	G3	
15/16" Tegular	T1	
9/16" Tegular	T2	
Drywall Frame Kit	F	
(Cut out dimensions: Min: 24.25"/Max: 24.563")		
Factory Options		
Chicago Plenum	CP	
Emergency Battery	EM	
6' New York City Flex Whip (120V)	FNY1	
6' New York City Flex Whip (277V)	FNY2	
6' Flex Whip	FW	
Finish		WH
Matte Satin White	WH	