

bottom detail



inside lens detail



grid ceiling canopy



white finish



palladium finish

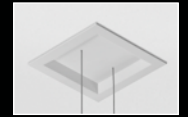

drywall canopy

DIMENSIONAL DATA

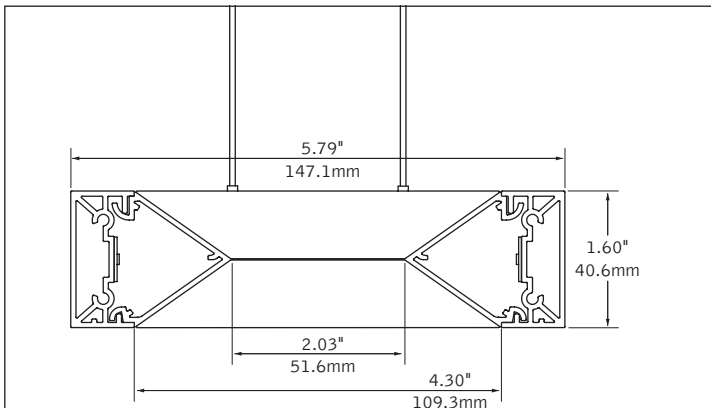

fixture information

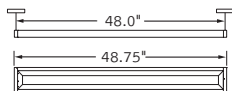

4'

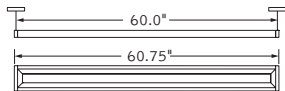

5'

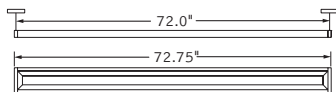

6'

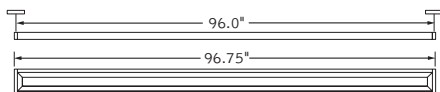

8'

FEATURES

Unique aesthetic inspired by the visual void design philosophy.

Luminaire lengths available in 4', 5', 6' and 8' lengths as well as continuous rows.

Frosted acrylic optical diffuser produces 40/60, 60/40 or 70/30 light distributions.

Features Power-Up suspension system which delivers power through the suspension cables and eliminates visual clutter of separate power cord.

Installations include grid, drywall and surface-mount/open ceilings.

Choice of output levels to meet a wide variety of application needs.

Connected Solutions: Integrates with wired and wireless building lighting control systems.

PERFORMANCE

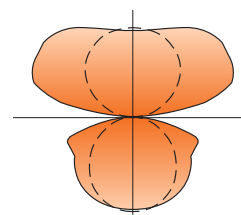

4' - 1000 Lumens per foot
Delivered Lumens: 4000lm
Total System Watts: 40W

PRODUCT OVERVIEW

Lumen Output:	2000-4000lm
Wattage:	18-38W
LPW:	106-115
SDCM:	3



Photometric performance is measured in accordance with IESNA LM-79. Visit focalpointlights.com for complete photometric data. Visit designlights.org/QPL for model specifics.

fixture:

project:

DETAILS

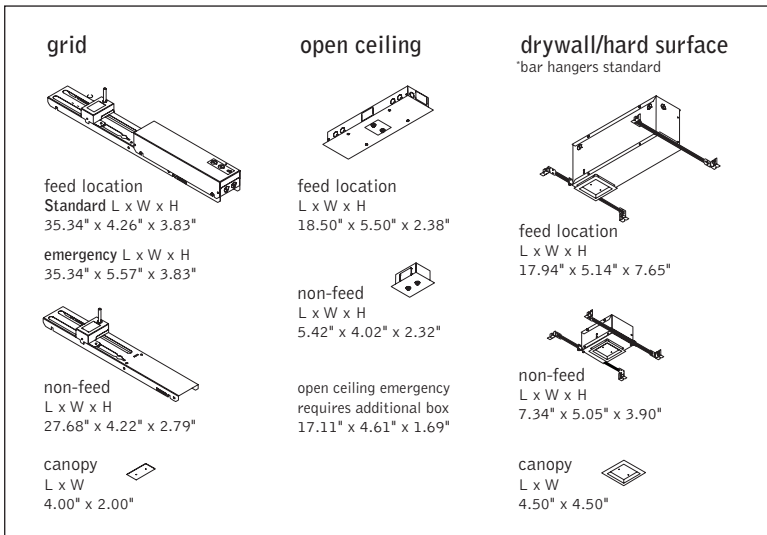

SPECIFICATIONS

LED System

Linear LED module incorporates premium LEDs on a robust platform to achieve excellent thermal management. Available in 3000K, 3500K, 4000K with CRI>80, 3 SDCM.

Construction

Extruded aluminum rails with die-cast aluminum end-caps. 4' unit weight: 4.8lbs. 5' unit weight: 5.9lbs. 6' unit weight: 7.0lbs. 8' unit weight: 9.8lbs.

Optic

0.125" thick extruded acrylic lens.

Mounting

White satin acrylic canopies provided for below ceiling access. Canopies are field paintable. Minimum mounting height: 12"

Suspension and Power

Low voltage power delivered via aircraft suspension/power cable. Adjustable suspension to 96", consult factory for longer lengths. Drivers in sheet metal enclosure above ceiling or surface mount for open ceilings. Drivers are replaceable. Standard 120-277V constant current driver includes 0-10V analog dimming. Power factor > .9.

Emergency

Bodine BSL-310LP. Emergency output for 90 minutes. Maximum mounting height: 15ft

Labels

UL and cUL listed. Suitable for Dry or Damp Locations, indoor use only.

Finish

Polyester powder coat applied over a multi-stage pre-treatment.

Lumen Maintenance

Reported: L90 at >36,000 hours Calculated: L90 at 100,000 hours
Derived from EPA TM-21 calculator. Based on typical conditions, consult factory for additional data.

Reliability

At Focal Point, our products are designed to stand the test of time. Each luminaire is engineered using superior components, manufactured with the utmost care and rigorously tested. Contact us for reliability data.

Warranty

LED system rated for operation in ambient environments up to 25°C. 5-year limited warranty.

4' PERFORMANCE CHART

Lumen Output	Delivered Lumens	System Watts		LPW	
		40/60	60/40 & 70/30	40/60	60/40 & 70/30
500LF	2000	18.1	17.7	110	114
625LF	2500	22.8	22.0	110	115
750LF	3000	27.6	26.6	109	114
875LF	3500	32.6	31.2	107	113
1000LF	4000	37.8	36.0	106	111

Lumen output may vary +/- 5%. Actual wattage may vary +/- 5%

Focal Point LLC reserves the right to change specifications for product improvement without notification.

ORDERING

Luminaire Series	FNRS
Nera	FNRS
Shielding	
Frosted Lens -	
40 Indirect / 60 Direct Distribution	FL40
Frosted Lens -	
60 Indirect / 40 Direct Distribution	FL60
Frosted Lens -	
70 Indirect / 30 Direct Distribution	FL70
Lumen Output	
500 Lumens per foot	500LF
625 Lumens per foot	625LF
750 Lumens per foot	750LF
875 Lumens per foot	875LF
(Not available with D11 or NLT1)	
1000 Lumens per foot	1000LF
(Not available with D11 or NLT1)	
(consult factory for higher light levels)	
Color Temperature	
3000K	30K
3500K	35K
4000K	40K
Circuits	1C
Single Circuit	1C
Voltage	UNV
UNV 120/277 Volt	UNV
Control System & Dimming Level	
0-10V - 1% Dimming	L11
0-10V - 10% Dimming	LD1
Lutron Hi-Lume EcoSystem (LDE1) -	
1% Dimming	LH1
Lutron 5-Series EcoSystem (LDE5) -	
5% Dimming	LU5
DALI - 1% Dimming	D11
(Not available with 875 or 1000 Lumens.)	
Acuity nLight - 1% Dimming	NLT1
(Not available with CP. Grid only.)	
Enlighted Smart Sensor - 1% Dimming	ENL1
(Remote mounted sensor. Grid only.)	
Osram Connected Lighting Module for	
ENCELIUM systems - 1% Dimming	CLM1
(Grid only. Compatible with Osram ENCELIUM and ENCELIUM EDGE systems only.)	
Osram Connected Lighting Module for	
ZigBee Wireless Networks - 1% Dimming	CLMZ1
(Grid only. Not compatible with Osram ENCELIUM systems.)	
Wattstopper DLM - 1% Dimming	DLM1
(Grid only.)	
Mounting	
Grid Accessible Ceiling	G
(Consult factory for TechZone Ceilings.)	
Drywall / Hard Surface	HS
(Not available with Emergency Battery)	
Open Ceiling	OC
Suspension and Power Feed	
(Adjustable aircraft cable with integral low voltage power delivery)	
24" adjustable	CLV24
48" adjustable	CLV48
60" adjustable	CLV60
96" adjustable	CLV96
Factory Options	
Clear Cable Sleeving	CCS
(May be required by local code)	
Chicago Plenum	CP
(Not available with Open Ceiling mounting. CCS shipped standard with CP option)	
Emergency Circuit	EC
Emergency Battery	EM
(Test switch in canopy. Not available with HS mounting.)	
Finish	
Palladium Silver	PS
White	WH
Luminaire Run Length	
4'	4'
5'	5'
6'	6'
8'	8'
Run Configuration	
all 4' housings	C4
all 5' housings	C5
all 6' housings	C6
all 8' housings	C8
Mixed housing lengths	M
(consult run guide on page 4 for standard configurations up to 48')	

Ordering example: Specify both total Luminaire Run Length and a Run Configuration
FNRS-FL60-625LF-35K-1C-UNV-LD1-G-CLV48-WHI-24-C8

For more information visit focalpointlights.com/reference or consult factory.

Focal Point provides flexibility in meeting the needs of each project by integrating with several building lighting control systems. A variety of sensors, drivers and other components can be specified that allow the luminaires to communicate with wired and wireless networks. All zoning can be digitally reconfigured through the application software. Daylight harvesting, occupancy sensing, integration with HVAC systems, and individual controls enable the monitoring and modulating of light levels and temperature in order to save energy, reduce costs and maximize occupants' comfort. All Connected Solutions luminaires require a compatible building control system.†

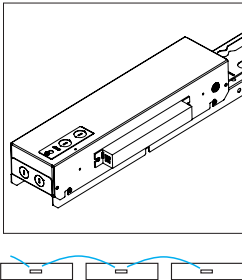

nLIGHT

nLight[®] provides a two-way wired digital lighting system allowing for on/off and dimming functionality, occupancy sensing, and multi-zone daylight harvesting.

Acuity nLight - 1% Dimming (NLT1)
Acuity Model #nEPS-60-IO

CAT-5 Cable provided by others. Serial labels will be provided on outside of luminaires and control unit.



enlighted

Enlighted smart sensor allows for occupancy sensing, daylight harvesting (not suitable for Nera), energy usage, temperature and light level control. Communicates wirelessly with the Enlighted network.

Enlighted Smart Sensor - 1% Dimming (ENL1)
Enlighted Model #SU-4E-01

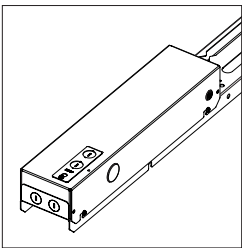

OSRAM

Connected Lighting Module (CLM) enables each luminaire to be independently controlled and configured. Communicates wirelessly with Daintree Networks[®], Osram ENCELIUM[®], Osram ENCELIUM EDGE[™], and other networks using the ZigBee[®] HA communication protocol to allow for on/off and dimming functionality, occupancy sensing and multi-zone daylight harvesting.

Osram CLM - 1% Dimming (CLM1 & CLMZ1)
Osram Model #ZBHA-CLM DIM

Serial labels will be provided on outside of luminaires and control unit.

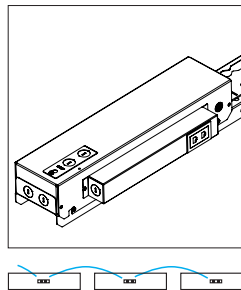

legrand[®] WATTSTOPPER[®]

A Digital Lighting Management (DLM) system that provides two-way wired communication between networked luminaires and control system to allow for on/off and dimming functionality, occupancy sensing and multi-zone daylight harvesting.

Wattstopper DLM - 1% Dimming (DLM1)
Wattstopper Model #LMFC-011

CAT-5 Cable provided by others. Serial labels will be provided on outside of luminaires and control unit.

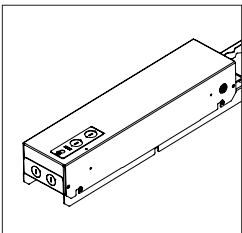

LUTRON[®]

A two-way digital network that enables on/off and dimming functionality, occupancy sensing, and multi-zone daylight harvesting working with Quantum[®], Energi Savr Node[™], and Energi TriPak[®] using EcoSystem[®] communication protocol.

Lutron Hi-Lume EcoSystem - 1% Dimming (LH1)
Lutron Model #LDE1
Lutron 5-Series EcoSystem - 5% Dimming (LU5)
Lutron Model #LDE5

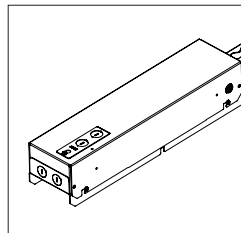

CRESTRON[®]

A two-way digital network that enables on/off and dimming functionality, occupancy sensing, and multi-zone daylight harvesting. Communicates with Züm wireless and SpaceBuilder working with Züm hub scheduling or FUSION management.

DALI - 1% Dimming (D11)
0-10V - 1% Dimming (L11)

Note: 0-10V is not a digital network but is compatible with Creston Züm[™] system.

CONNECTED SOLUTIONS DETAILS

Connected Solution	Model #	Protocol	Compatible Networks*	Occupancy	Daylight	Temperature Reporting	Communication to Luminaire	Drivers
Acuity nLight (NLT1)	nEPS-60-IO**	nLight	nLight	Enabled	Enabled	No	Wired	eldoLED ECOdrive , eldoLED SOLOdrive
Crestron (D11, L11)	Specified Driver	DALI 0-10V	Crestron Züm Wireless & SpaceBuilder	Enabled	Enabled	No	Wired	eldoLED ECOdrive (DALI) , Philips Xitanium (0-10V)
Enlighted Smart Sensor (ENL1)	SU-4E-01**	Enlighted RF	Enlighted	Integrated	Not suitable	Yes	Wireless	Philips SimpleSet
Legrand Wattstopper DLM (DLM1)	LMFC-011**	DLM	DLM	Enabled	Enabled	No	Wired	Philips SimpleSet
Lutron EcoSystem (LH1 & LU5)	LDE1,** LDE5**	EcoSystem	Quantum, Energi Savr Node, Energi TriPak	Enabled	Enabled	No	Wired	Lutron Hi-Lume Lutron 5-Series
Osram CLM for ENCELIUM systems (CLM1)	ZBHA-CLM**	ZigBee HA	Osram ENCELIUM & ENCELIUM EDGE	Enabled	Enabled	No	Wireless	Osram Optotronic
Osram CLM for ZigBee Wireless Networks (CLMZ1)	ZBHA-CLM**	ZigBee HA	Daintree Networks & open ZigBee Networks	Enabled	Enabled	No	Wireless	Osram Optotronic

*Not all compatible networks may be listed. **For performance data and additional control system details please visit the connected solutions manufacturer websites. Primary drivers are listed in bold. To specify a particular driver please consult factory. †Controls systems supplied by others.

RUN GUIDE

EXAMPLE 15' RUN - FNRS-FL60-625LF-35K-1C-UNV-LD1-G-CLV48-WH-15-C5

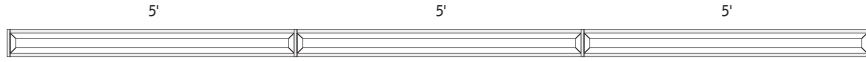

EXAMPLE 20' RUN - FNRS-FL60-625LF-35K-1C-UNV-LD1-G-CLV48-WH-20-M

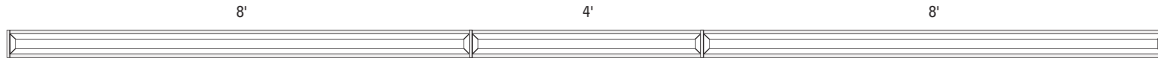

STANDARD RUNS

Luminaire Run Length (ft)	Run Configuration	Run Configuration Code
4	4'	C4
5	5'	C5
6	6'	C6
8	8'	C8
12	8' + 4'	M
16	8' + 8'	C8
20	8' + 4' + 8'	M
24	8' + 8' + 8'	C8
30	8' + 8' + 8' + 6'	M
32	8' + 8' + 8' + 8'	C8
36	8' + 8' + 8' + 8' + 4'	M
40	8' + 8' + 8' + 8' + 8'	C8
44	8' + 8' + 8' + 8' + 8' + 4'	M
48	8' + 8' + 8' + 8' + 8' + 8'	C8

NON-STANDARD RUNS

Luminaire Run Length (ft)	Run Configuration	Run Configuration Code
8	4' + 4'	C4
10	5' + 5'	C5
12	4' + 4' + 4'	C4
12	6' + 6'	C6
14	8' + 6'	M
15	5' + 5' + 5'	C5
16	4' + 4' + 4' + 4'	C4
18	6' + 6' + 6'	C6
20	4' + 4' + 4' + 4' + 4'	C4
20	5' + 5' + 5' + 5'	C5
24	4' + 4' + 4' + 4' + 4' + 4'	C4
24	6' + 6' + 6' + 6'	C6
25	5' + 5' + 5' + 5' + 5'	C5
28	4' + 4' + 4' + 4' + 4' + 4' + 4'	C4
28	8' + 6' + 6' + 8'	M
30	5' + 5' + 5' + 5' + 5' + 5'	C5
30	6' + 6' + 6' + 6' + 6'	C6
32	4' + 4' + 4' + 4' + 4' + 4' + 4' + 4'	C4
35	5' + 5' + 5' + 5' + 5' + 5'	C5
36	4' + 4' + 4' + 4' + 4' + 4' + 4' + 4' + 4'	C4
36	6' + 6' + 6' + 6' + 6' + 6'	C6
38	8' + 8' + 8' + 8' + 6'	M
40	4' + 4' + 4' + 4' + 4' + 4' + 4' + 4' + 4' + 4'	C4
40	5' + 5' + 5' + 5' + 5' + 5' + 5' + 5'	C5
42	6' + 6' + 6' + 6' + 6' + 6' + 6'	C6
44	4' + 4' + 4' + 4' + 4' + 4' + 4' + 4' + 4' + 4' + 4'	C4
45	5' + 5' + 5' + 5' + 5' + 5' + 5' + 5' + 5'	C5
46	8' + 8' + 8' + 8' + 8' + 6'	M
48	4' + 4' + 4' + 4' + 4' + 4' + 4' + 4' + 4' + 4' + 4' + 4'	C4
48	6' + 6' + 6' + 6' + 6' + 6' + 6' + 6'	C6
>48	Consult Factory	Consult Factory