

ARENA – SLICE 8293

PROJECT PROJÉT
SPEC TYPE
NOTES

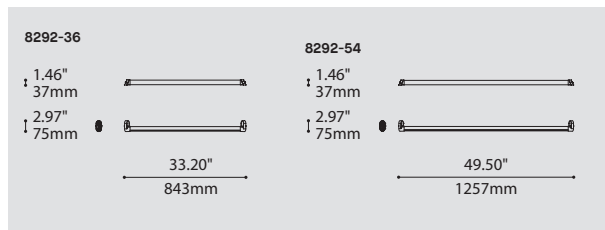
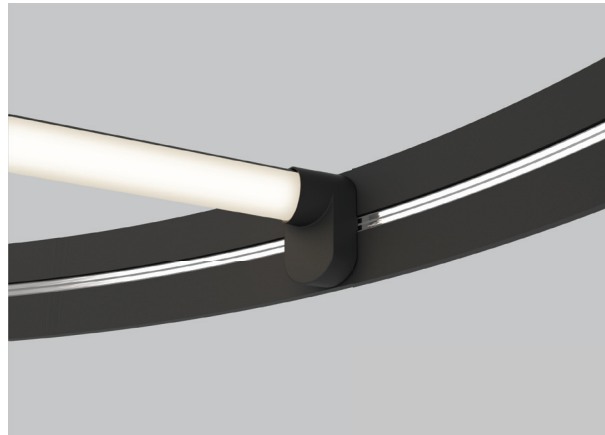

ORDERING SPECIFICATION SPÉCIFICATION DE COMMANDE

MODEL MODÈLE		CODE
8293-36	ARENA – SLICE 36" (ONLY FOR 8200-36) *	
8293-54	ARENA – SLICE 54" (ONLY FOR 8200-54) *	
* ARENA – SLICE IS AN ACCESSORY LIGHT SOURCE USED WITH ARENA 8200 (SOLD SEPARATELY)		
LIGHT SOURCE SOURCE LUMINEUSE		LED
LED	REGULAR OUTPUT, 6W FOR 8293-36 & 9W FOR 8293-54 *	
TOTAL DC LOAD OF INSTALLED LIGHT SOURCES (8290, 8291, 8292, 8293-36, 8293-54) MUST NOT EXCEED 100W. * A MAXIMUM OF 4 ARENA – SLICE CAN BE ATTACHED TO A SINGLE ARENA 8200		
COLOR TEMPERATURE TEMPÉRATURE DE COULEUR		
30	3000K	
35	3500K	
40	4000K	
STRUCTURE FINISH FINI STRUCTURE		
BLKE	BLACK FINE TEXTURE	
WHE	WHITE FINE TEXTURE	
DIFFUSER FINISH FINI DIFFUSEUR		WH
WH	WHITE	

PRODUCT CHARACTERISTICS CARACTÉRISTIQUES DU PRODUIT



DESIGN: ARENA – SLICE is an eye-catching graphic linear light source for ARENA (8200). Up to four accessories can be arranged or intersected on an ARENA ring creating unique pattern effects.

INSTALLATION: Magnetically positioned anywhere on the ARENA for easy on-site installation or reconfiguration of the lighting environment. A maximum of up to 4 ARENA – SLICE can be installed on each ARENA or can be combined with other accessories for a total load of up to 100W.

LIGHT SOURCE: LED linear light engine with custom engineered acrylic diffuser. Each ARENA – SLICE can be rotated 180° on-site for direct or indirect illumination and can be placed on overlapping heights for a unique intersecting look.

STRUCTURE: Custom designed aluminum extrusion with aluminum diecast endcaps offered in white or black architectural grade finish.

CERTIFIED: c-CSA-us

CONCEPTION: ARENA – SLICE est une source lumineuse linéaire contemporaine pour ARENA (8200). Jusqu'à quatre accessoires peuvent être installés ou intersectés sur l'anneau ARENA créant ainsi des motifs d'éclairage uniques.

INSTALLATION: Positionné magnétiquement n'importe où sur l'ARENA pour faciliter l'installation ou la reconfiguration de l'éclairage sur site. Un maximum de 4 ARENA – SLICE peuvent être installés sur chaque ARENA ou être combinés avec d'autres accessoires jusqu'à une charge maximale de 100W.

SOURCE LUMINEUSE: Source LED linéaire avec diffuseur en acrylique conçu sur mesure. Chaque ARENA – SLICE peut être pivoté sur 180° pour un éclairage direct ou indirect et peuvent être placés sur deux niveaux superposés pour un effet de lignes entrecroisées.

STRUCTURE: Extrusion en aluminium conçue sur mesure avec embouts en aluminium moulés offert avec une finition noire ou blanche de grade architectural.

CERTIFIÉ: c-CSA-us

REFERENCE CHART TABLEAU DE RÉFÉRENCE

RING	LIGHT SOURCES				
ARENA 8200-36 & 8200-54	BEAM 8290	GLOW 8291	AIM 8292	SLICE 8293-36	SLICE 8293-54
MAXIMUM DC LOAD 100W	7W DC	7W DC	7W DC	6W DC	9W DC

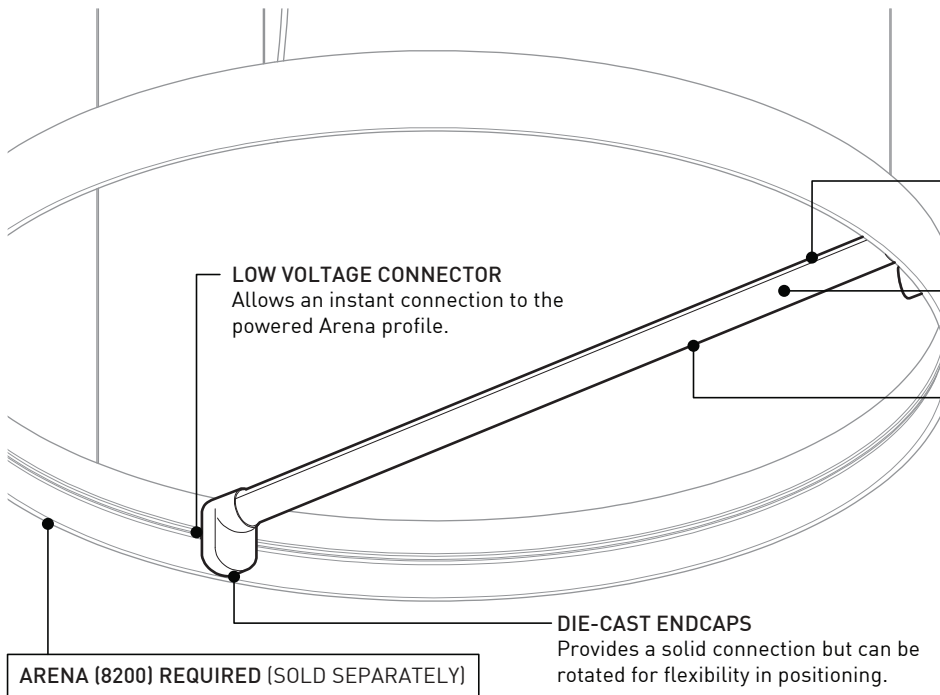

SLICE is an eye-catching graphic linear light source for ARENA 8200 (sold separately). A maximum of four SLICE can be placed on an ARENA and can be arranged in various orientations to create unique patterns

SIZES

The SLICE 36 fits only on ARENA 8200-36
The SLICE 54 fits only on ARENA 8200-54

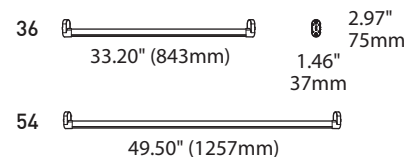

FIT UP TO 4 SLICE PER ARENA:

Example configurations of maximum four SLICE on the ARENA (sold separately)

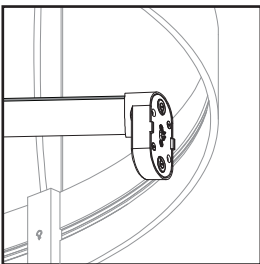
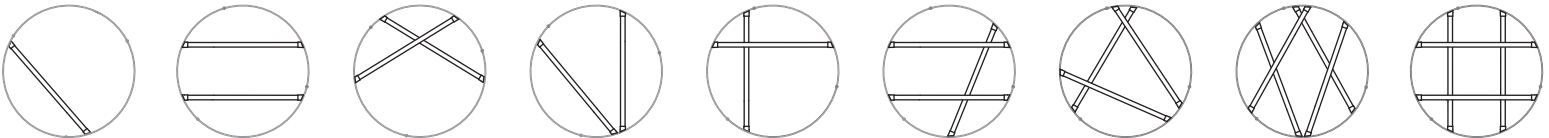

Attach
Secured by strong neodymium magnets. Tested to UL standards to support several times its weight.

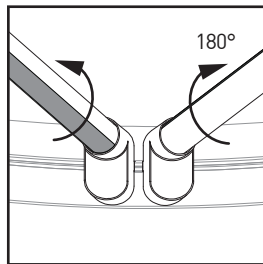

Rotate
Rotatable up to a 180° angle for downlight or uplight illumination.

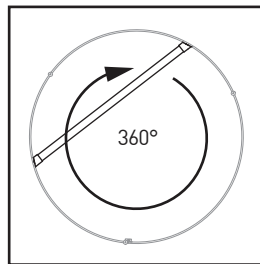

Move
Can be placed 360° around the ARENA.

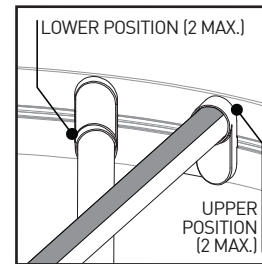

Flip
SLICE can be flipped to the upper or lower position on the ARENA

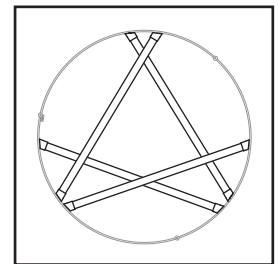

Overlap
Place up to 2 up & 2 down to create an overlapping light pattern. A Max of 4 SLICE can fit per ARENA .

SPECIFICATIONS

LIGHT SOURCE
DELIVERED LUMENS
CRI
MAX UNITS
LIGHT DISTRIBUTION
OPTIC
HEATSINK
DIMMING
WARRANTY
WEIGHT

8293-36

Linear LED (6W DC load)
1046lm (COLOR: 4000K, STRUCTURE: WHITE, DIFFUSER: WHITE)
85 CRI Typical
MAX. 4 SLICE 36" per 36" ARENA
180° Rotatable Uplight or Downlight. Positionable 360° within ARENA.
Extruded custom acrylic frosted lens
Extruded aluminum with a fine textured powder coat finish
0-10V dimming (DV)
5 years
1.24lbs/560g per unit

8293-54

Linear LED (9W DC load)
1560lm (COLOR: 4000K, STRUCTURE: WHITE DIFFUSER: WHITE)
MAX. 4 SLICE 54" per 54" ARENA
1.65lbs/750g per unit



225 de Liège Ouest, Suite #200
Montréal (QC), Canada H2P 1H4
Tel : 514.385.3515 Fax : 514.385.4169
www.eurekalighting.com



8293-36
8293-54

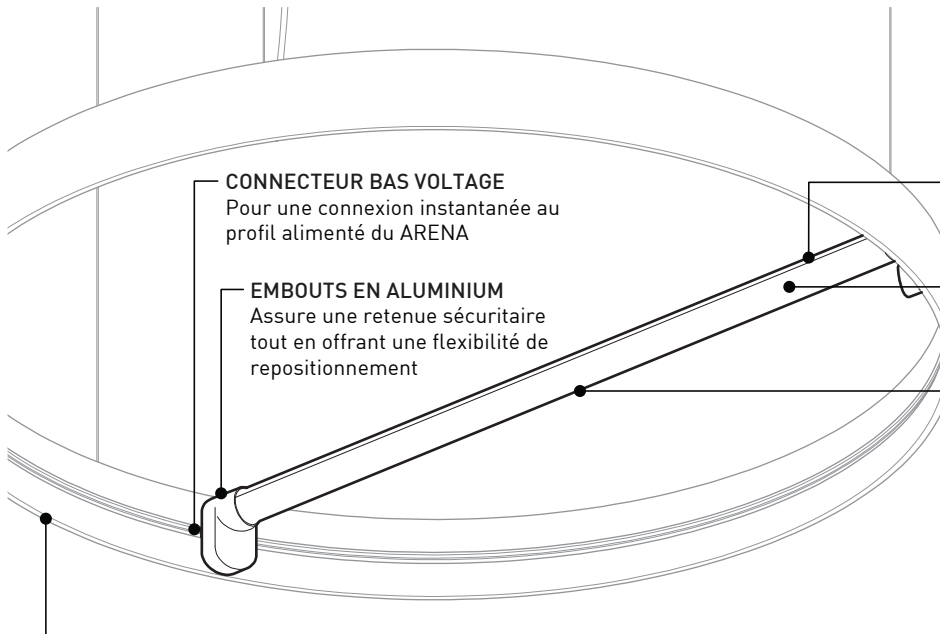

SLICE est une attrayante source lumineuse linéaire pour le ARENA 8200 (vendu séparément). Jusqu'à quatre éléments peuvent être placés sur le ARENA et peuvent être arrangés selon différentes orientations afin de créer des motifs uniques

CONNECTEUR BAS VOLTAGE
Pour une connexion instantanée au profil alimenté du ARENA

EMBOUS EN ALUMINIUM
Assure une retenue sécuritaire tout en offrant une flexibilité de repositionnement

DISSIPATEUR EN ALUMINIUM EXTRUDÉ
Conçu sur mesure pour une dissipation thermique optimale

SOURCE LUMINEUSE
Source lumineuse DEL de puissance moyenne, uniforme sur la pleine longueur

OPTIQUE
Le diffuseur en acrylique sur mesure crée une illumination ambiante de type lambertienne

TAILLES

Le SLICE 36 est compatible avec l'ARENA 8200-36
Le SLICE 54 est compatible avec l'ARENA 8200-54

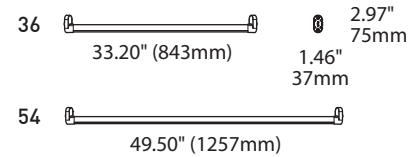

ARENA (8200) REQUIS (VENDU SÉPARÉMENT)

PLACER JUSQU'À 4 SLICE SUR LE ARENA:

Exemples de configurations de maximum quatre SLICE sur le ARENA 8200 (vendu séparément)

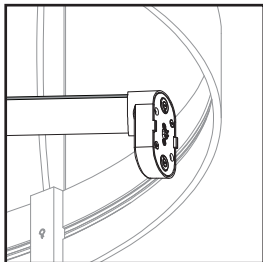
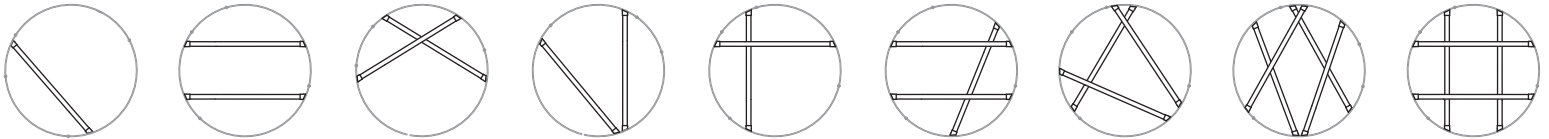

Attachez
Sécurisé par de puissants aimants en néodyme. Testé selon UL pour supporter plusieurs fois leur poids

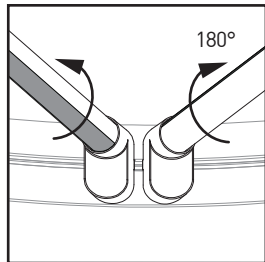

Tournez
Orientable sur un angle de 180° pour une illumination vers le haut ou le bas

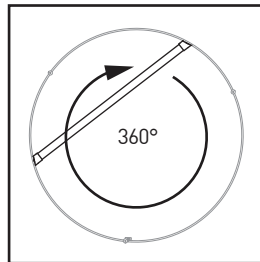

Déplacez
Peut être déplacé sur 360° autour du ARENA

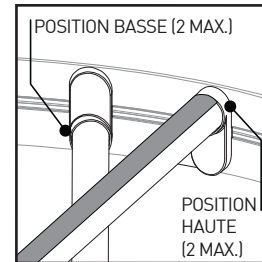

Retournez
SLICE peut être renversé à la position supérieure ou inférieure du ARENA

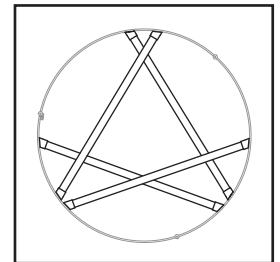

Chevauchez
Placer jusqu'à 2 en haut & 2 en bas pour un motif superposé. Un ARENA accueille 4 SLICE maximum.

SPÉCIFICATIONS

SOURCE LUMINEUSE
LUMENS RÉELS
IRC
DISTRIBUTION LUMINEUSE
OPTIQUE
DISSIPATEUR THERMIQUE
GRADATION
UNITÉS MAXIMUM
GARANTIE
POIDS

8293-36

DEL linéaire (Charge DC 6W)
1046lm [COULEUR: 4000K, STRUCTURE: WHE, DIFFUSER: WH]
85 CRI typique
Illumination orientable 180° vers le haut ou le bas. Peut être déplacé sur 360° à l'intérieur du ARENA
Lentille en acrylique extrudée
Aluminium extrudé avec un fini en poudre finement texturé
Gradation 0-10V [DV]
MAX. 4 SLICE 36" per 36" ARENA
5 ans
1.24lbs/560g par unité

8293-54

DEL linéaire (Charge DC 9W)
1560lm [COULEUR: 4000K, STRUCTURE: WHE, DIFFUSER: WH]
Illumination orientable 180° vers le haut ou le bas. Peut être déplacé sur 360° à l'intérieur du ARENA
Lentille en acrylique extrudée
Aluminium extrudé avec un fini en poudre finement texturé
Gradation 0-10V [DV]
MAX. 4 SLICE 54" per 54" ARENA
1.65lbs/750g par unité

Configure Arena in two easy steps

1

Choose your **Arena** options

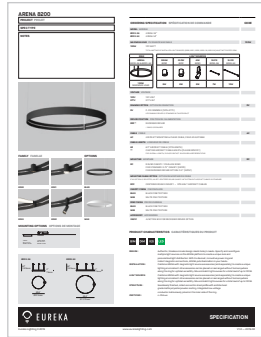

2

Configure **light sources** as needed

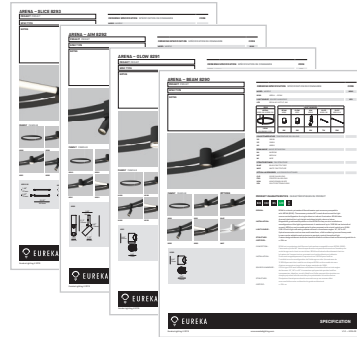

Our favorites



1 × ARENA 54"
6 × ARENA – AIM



1 × ARENA 54"
12 × ARENA – BEAM



1 × ARENA 54"
12 × ARENA – GLOW



1 × ARENA 54"
4 × ARENA – SLICE 54"

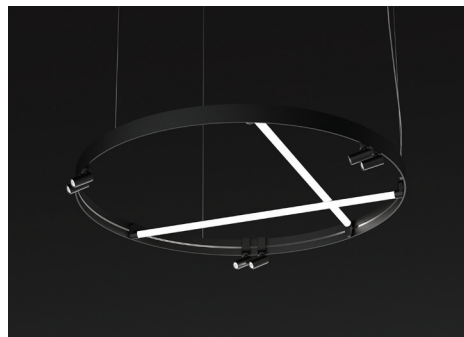

1 × ARENA 54"
2 × ARENA – SLICE 54"
6 × ARENA – AIM



1 × ARENA 54"
2 × ARENA – SLICE 54"
2 × ARENA – GLOW

ARENA 8200

PROJECT PROJÉT
SPEC TYPE
NOTES

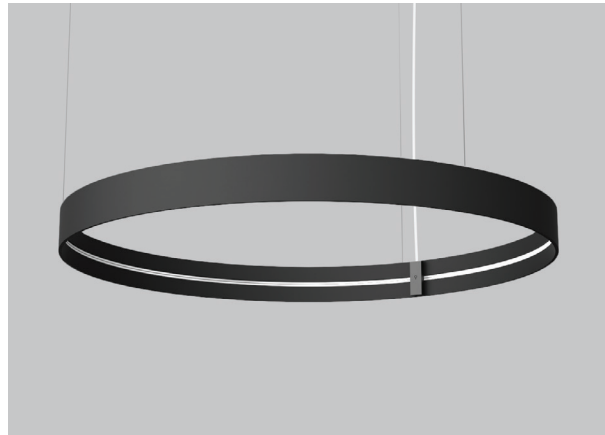

FAMILY FAMILLE



FINISH FINI



MOUNTING OPTIONS OPTIONS DE MONTAGE

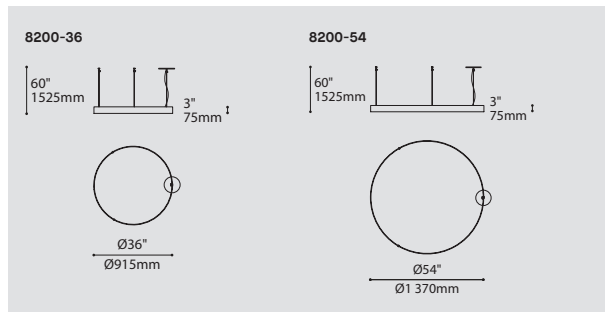
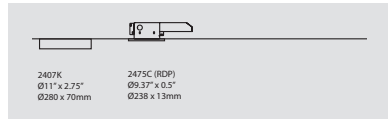

ORDERING SPECIFICATION SPÉCIFICATION DE COMMANDE

CODE

MODEL MODÈLE

8200-36 ARENA 36"
8200-54 ARENA 54"

MAXIMUM DC LOAD PUISSANCE MAXIMALE DC

100W 100 WATT DC
TOTAL DC LOAD OF INSTALLED LIGHT SOURCES (8290, 8291, 8292, 8293-36, 8293-54) MUST NOT EXCEED 100W.

RING
ARENA 8200-36 & 8200-54
MAXIMUM DC LOAD 100W

LIGHT SOURCES				
BEAM 8290	GLOW 8291	AIM 8292	SLICE 8293-36	SLICE 8293-54
7W DC	7W DC	7W DC	6W DC	9W DC

VOLTAGE VOLTAGE

120V 120 VOLT
277V 277 VOLT

DIMMING OPTION OPTION DE GRADATION

DV 0-10V DIMMING (120V-277V)
LED DIMMING DRIVER IS STANDARD IN THIS PRODUCT

DRIVER POSITION POSITION DE L'ALIMENTATION

RDP * RECESSED DRIVER
* 3981C IS REQUIRED

CABLE CÂBLE

AC AIRCRAFT MOUNTING & CLEAR CABLE, FIELD ADJUSTABLE

CABLE LENGTH LONGUEUR DE CÂBLE

60 60" AIRCRAFT CABLE (STD LENGTH)
** CUSTOM AIRCRAFT CABLE LENGTH (PLEASE SPECIFY)
FOR OVERALL LENGTH, PLEASE CONTACT YOUR EUREKA REPRESENTATIVE.

MOUNTING MONTAGE

RC ROUND CANOPY / PAVILLON ROND
FOR STANDARD: 2.75" CANOPY (2407K)
FOR RECESSED DRIVER OPTION: 0.5" (2475C)

MOUNTING CABLE OPTION OPTION DE MONTAGE DE CÂBLE

IF NO OPTION IS SELECTED, AN OFF-CENTERED ROUND CANOPY WITH STRAIGHT AIRCRAFT CABLES IS STANDARD

RCC CENTERED ROUND CANOPY - STRAIGHT AIRCRAFT CABLES

CANOPY FINISH FINI PAVILLON

BLKE BLACK FINE TEXTURE
WHE WHITE FINE TEXTURE

RING FINISH FINI DE L'ANNEAU

BLKE BLACK FINE TEXTURE
WHE WHITE FINE TEXTURE

ACCESSORY ACCESSOIRE

3981C JUNCTION BOX FOR RECESSED DRIVER OPTION

PRODUCT CHARACTERISTICS CARACTÉRISTIQUES DU PRODUIT



- DESIGN:** Authentic, timeless circular design meets today's needs. Specify and reconfigure multiple light sources on the ARENA platform to create a unique look and personalized light distribution. With its discreet, innovative power ring and instant magnetic connections, ARENA puts illumination in your hands.
- INSTALLATION:** Combine ARENA with magnetic light source accessories (sold separately) to create a unique lighting environment. All accessories can be placed or rearranged without tools anywhere along the ring for optimal versatility. Mix and match light sources for a total load of up to 100W.
- LIGHT SOURCE:** Combine ARENA with magnetic light source accessories (sold separately) to create a unique lighting environment. All accessories can be placed or rearranged without tools anywhere along the ring for optimal versatility. Mix and match light sources for a total load of up to 100W.
- STRUCTURE:** Seamlessly finished, rolled concentric steel profile with architectural grade matte polyester powder coating. Integrated low-voltage conductor meticulously joined on the inner side of the ring.
- CERTIFIED:** c-CSA-us



SPECIFICATION

EVOLVING LIGHT

ARENA is the circular base profile that supports and powers a variety of compatible light sources which can be combined and positioned as desired.

The ARENA will accommodate a choice of light sources which can be customized in quantity, position, orientation and combinations to provide users with a tailored solution for their space.

RELOCATE

Easily relocated power feed to anywhere around the ring for flexibility in canopy locations

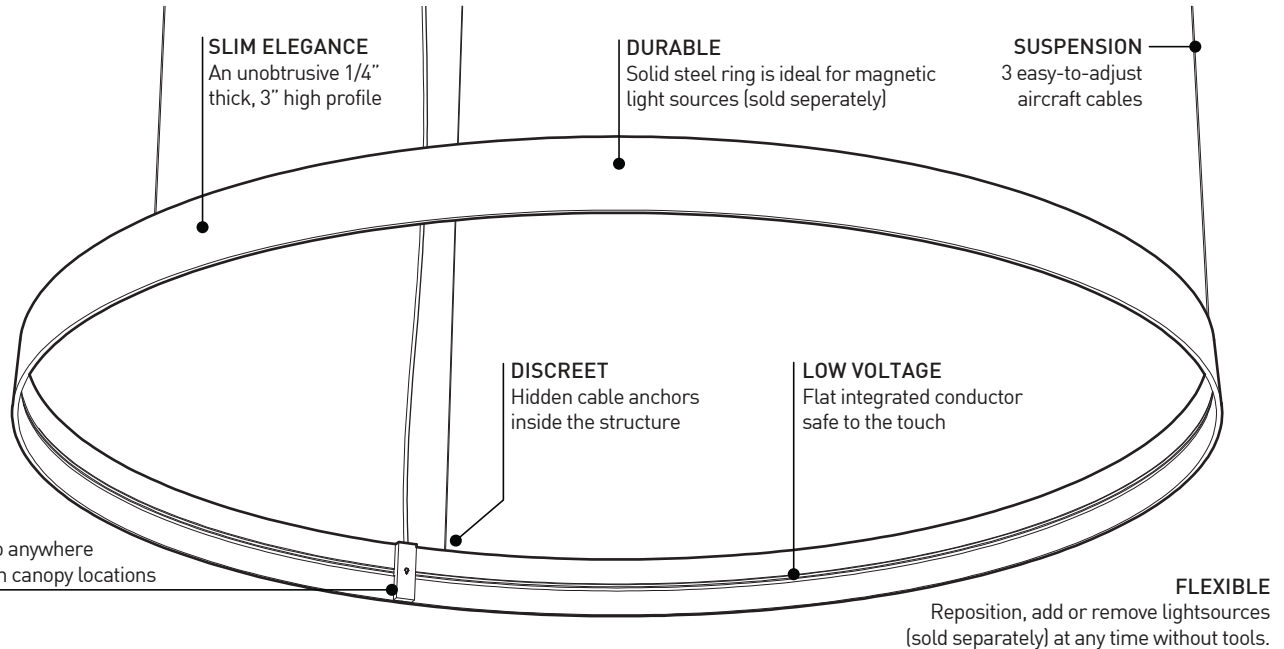

SIZES

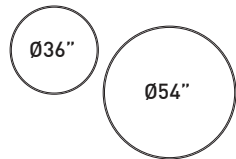

2 sizes Allow multiple combinations for a variety of spaces

CANOPY POSITION

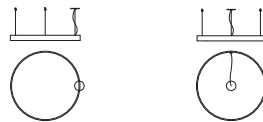

Standard (fixed location)
Centered with mounting point

RCC (flexible location)
Independent from the mounting point

CANOPY TYPE

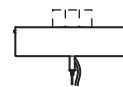

STANDARD CANOPY 11\"X2.75\"
Mounting on a 4\" standard j-box

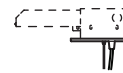

LOW PROFILE CANOPY 9.4\"X0.25\"
Mounting on Eureka box 3981C (sold separately, can be shipped and installed in advance)
Recessed driver for discreet installation
Min. 3.5\" inside ceiling clearance required

LIGHT SOURCES :

Several light source accessories are available for ARENA. They are sold separately in the quantity and type desired. Different types can be combined

Please refer to their individual product pages for more information

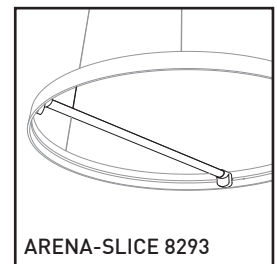
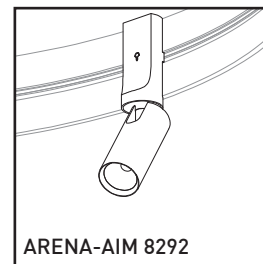
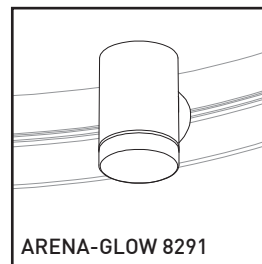
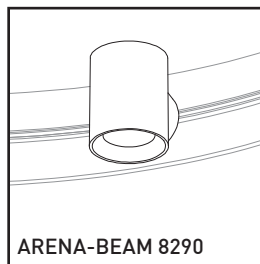

SPECIFICATIONS

STRUCTURE

LIGHT SOURCES

POWER

VOLTAGE

DIMMING

WARRANTY

WEIGHT

8200-36

Cold rolled steel formed, polished with a powder coat finish

Sold separately. Please refer to light sources 8290, 8291, 8292, 8293

Max AC power consumption 120W / Max 100W DC load of installed light sources (8290, 8291, 8292, 8293-36, 8293-54)

120V or 277V

0-10V dimming (DV)

5 years

24lbs (10.9kg), Max 34.6lbs (15.7kg) with 12 Light sources

8200-54

40lbs (18.2kg), Max 52.2lbs (23.7kg) with 12 Light sources

LUMIÈRE ÉVOLUTIVE

ARENA est la base circulaire qui supporte et alimente une variété de sources lumineuses compatibles pouvant être combinées et positionnées selon vos désirs

ARENA accommodera un choix de sources lumineuses pouvant être personnalisées en quantité, position, orientation et combinaison afin de permettre à l'utilisateur une solution adaptée à l'espace

RELOCALISEZ

Source d'alimentation amovible pouvant être relocalisée sur l'anneau afin d'accommoder la localisation du pavillon

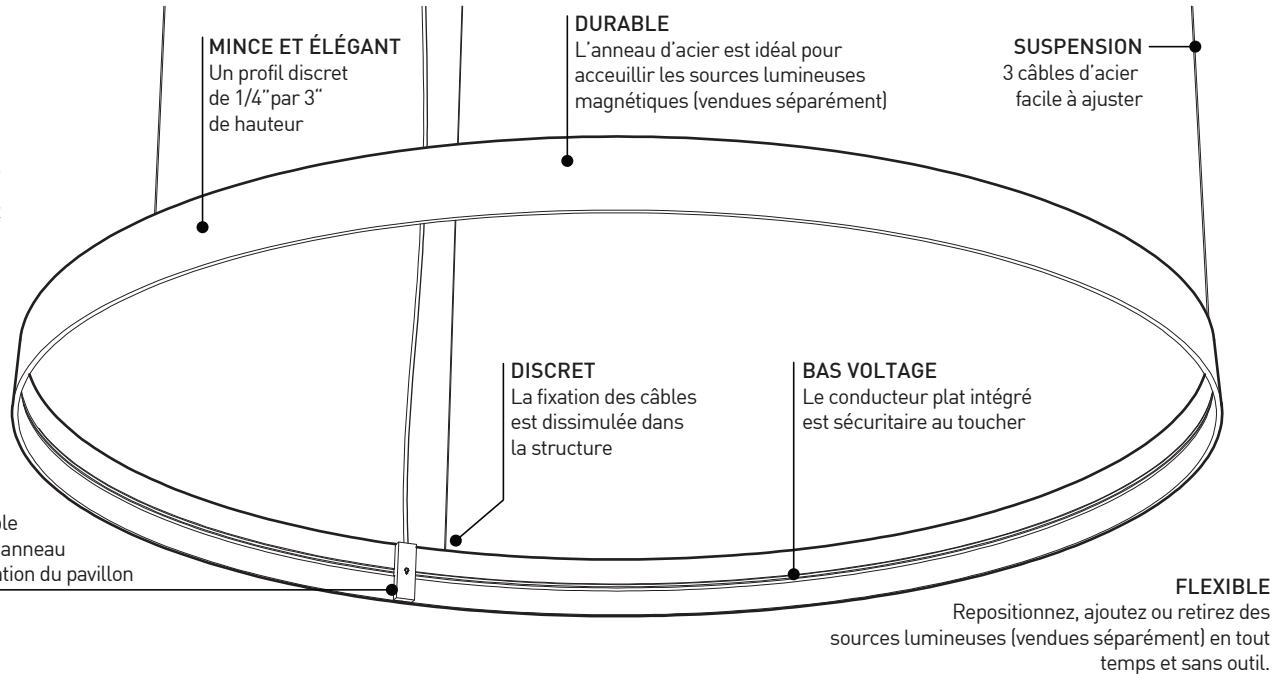

TAILLES

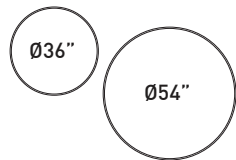

2 tailles
Permettent une multitude de combinaisons pour une variété d'espaces.

POSITION DU PAVILLON

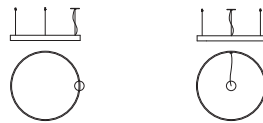

Standard (location fixe)
Centré avec un point de montage

RCC (location flexible)
Indépendant du point de montage

TYPE DE PAVILLON

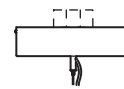

PAVILLON STANDARD 11"X2.75"
Installation sur une boîte de jonction 4" standard

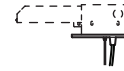

PAVILLON BAS PROFILE 9.4"X0.25"
Installation sur une boîte Eureka 3981C (vendue séparément, peut être livrée séparément pour une installation en avance)
Pilote encastré pour installation discrète
Jeu de 3.5" minimum dans le plafond requis

SOURCES LUMINEUSES :

Plusieurs accessoires lumineux sont disponibles pour ARENA. Vendues séparément dans la quantité et le type désiré. Les modèles peuvent être combinés

Se référer aux pages individuelles des produits pour plus d'informations

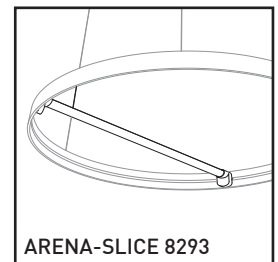
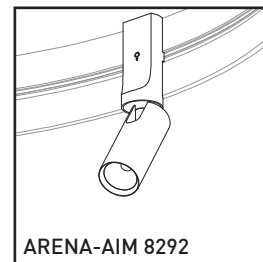
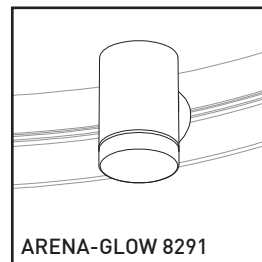
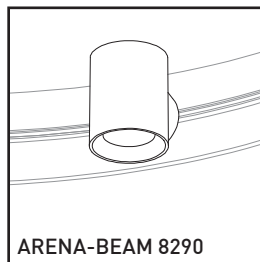

SPÉCIFICATIONS

STRUCTURE

SOURCE LUMINEUSE

PUISSANCE TOTALE

VOLTAGE

GRADATION

GARANTIE

POIDS

8200-36

Acier roulé à froid, fini avec un revêtement en poudre

Vendues séparément. Veuillez vous référer aux sources lumineuses 8290, 8291, 8292, 8293

Consommation max AC 120W / Max 100W DC des sources lumineuses installées (8290, 8291, 8292, 8293-36, 8293-54)

120V or 277V

Gradation 0-10V (DV)

5 ans

24lb (10.9kg), Max 34.6lb (15.7kg) avec 12 sources lumineuses

8200-54

40lb (18.2kg), Max 52.2lb (23.7kg) avec 12 sources lumineuses