

ARENA – GLOW 8291

PROJECT PROJÉT
SPEC TYPE
NOTES



FAMILY FAMILLE



ARENA 8200

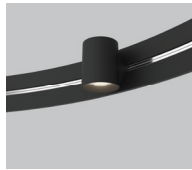

ARENA – BEAM 8290

FINISH FINI



BLKE



ARENA – AIM 8292



ARENA – SLICE 8293



WHE



ORDERING SPECIFICATION SPÉCIFICATION DE COMMANDE

CODE

MODEL MODÈLE

8291

8291 ARENA – GLOW*
*ARENA – GLOW IS AN ACCESSORY LIGHT SOURCE USED WITH ARENA 8200 (SOLD SEPARATELY)

LIGHT SOURCE SOURCE LUMINEUSE

LED

LED REGULAR OUTPUT, 7W
TOTAL DC LOAD OF INSTALLED LIGHT SOURCES (8290, 8291, 8292, 8293-36, 8293-54) MUST NOT EXCEED 100W.

COLOR TEMPERATURE TEMPÉRATURE DE COULEUR

30 3000K
35 3500K
40 4000K

BEAM ANGLE ANGLE DE FAISCEAU

ME

ME MEDIUM (26°)

STRUCTURE FINISH FINI STRUCTURE

BLKE BLACK FINE TEXTURE
WHE WHITE FINE TEXTURE

OPTICAL ACCESSORIES ACCESSOIRES OPTIQUES

FRO

FRO FROSTED LENS

PRODUCT CHARACTERISTICS CARACTÉRISTIQUES DU PRODUIT



- DESIGN:** With its thick clear-cut crystalline diffuser, ARENA – GLOW adds a touch of ambient luxury to the stately ARENA (8200) ring profile. Using the same 62mm body of ARENA – BEAM, the accessory rotates 90° in each direction and can be flipped vertically on the ring to enable direct or indirect illumination.
- INSTALLATION:** Magnetically positioned anywhere on the ARENA for easy on-site installation or reconfiguration of the lighting environment. A maximum of up to 12 ARENA – GLOW can be installed on each ARENA or can be combined with other accessories for a total load of up to 100W.
- LIGHT SOURCE:** COB LED combined with machined acrylic diffuser. The diffuser has a frosted interior surface for a smooth light diffusion and a perfectly polished exterior giving it a jewel-like look.
- STRUCTURE:** Custom designed diecast aluminum heatsink offered in white or black architectural grade finish. c-CSA-us
- CERTIFIED:**
- CONCEPTION:** Avec son diffuseur massif et cristallin, ARENA – GLOW ajoute une touche luxueuse à l'anneau ARENA (8200). En utilisant le même corps de 62 mm de ARENA – BEAM, l'accessoire pivote sur 90° dans chaque direction et peut être inversé sur l'anneau pour une illumination directe ou indirecte.
- INSTALLATION:** Positionné magnétiquement n'importe où sur l'ARENA pour faciliter l'installation ou la reconfiguration de l'éclairage sur site. Un maximum de 12 ARENA – GLOW peuvent être installés sur chaque ARENA ou être combinés avec d'autres accessoires jusqu'à une charge maximale de 100W.
- SOURCE LUMINEUSE:** LED de type COB combiné à un diffuseur en acrylique usiné. Le diffuseur a une surface intérieure givrée pour une diffusion douce de la lumière et un extérieur parfaitement poli lui attribuant un aspect luxueux.
- STRUCTURE:** Dissipateur thermique en aluminium moulé conçu sur mesure offert avec une finition noire ou blanche de grade architectural.
- CERTIFIÉ:** c-CSA-us

REFERENCE CHART TABLEAU DE RÉFÉRENCE

RING	LIGHT SOURCES				
	BEAM 8290	GLOW 8291	AIM 8292	SLICE 8293-36	SLICE 8293-54
ARENA 8200-36 & 8200-54					
MAXIMUM DC LOAD 100W	7W DC	7W DC	7W DC	6W DC	9W DC

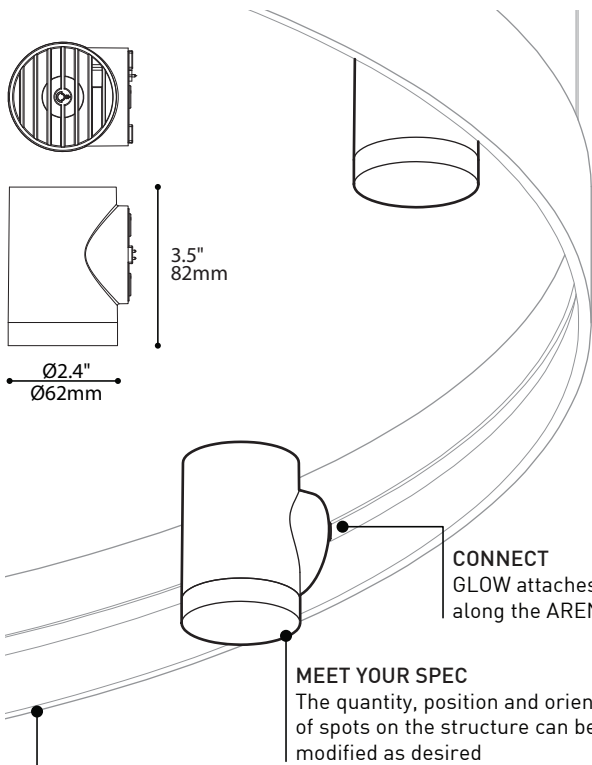

A SOFT AMBIENT GLOW

With its thick clear-cut crystalline diffuser, the GLOW adds a touch of ambient luxury to the stately ARENA (8200) ring profile (sold separately). It can be displaced, flipped up or down and rotated left or right instantly without tools

DIE-CAST ALUMINUM HEATSINK
Custom designed for optimal heat dissipation, black or white textured finish

HIGH POWER COB LED
Single point source with high performance efficiency

COMPACT REFLECTOR
Aluminum coated reflector for efficient light output

SOLID DIFFUSER
A combination of clear and frosted acrylic diffuser for a jewel like appearance

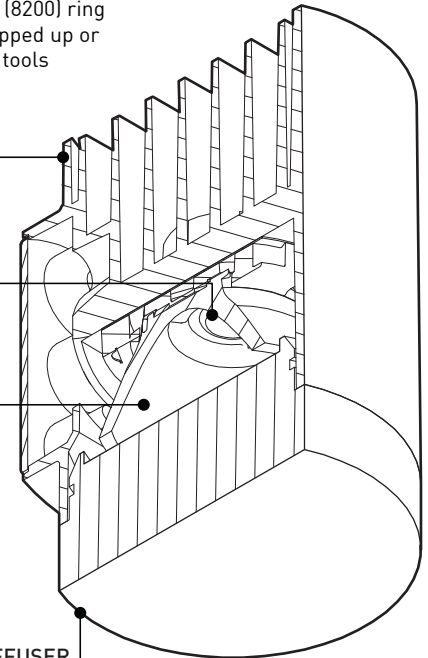

ARENA (8200) REQUIRED (SOLD SEPARATELY)

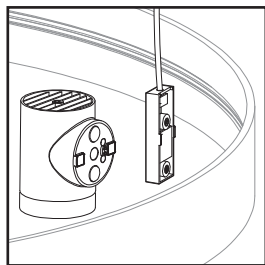

Attach
Secured by strong neodymium magnets. Tested to UL standards to support several times its weight

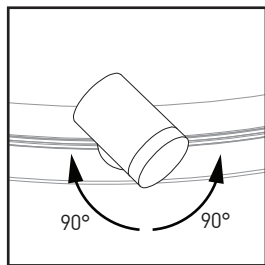

Rotate
GLOW can be rotated sideways up to 90° in each direction to help highlight a particular area or object

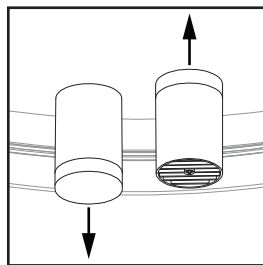

Flip
GLOW can be flipped up or down for direct or indirect illumination

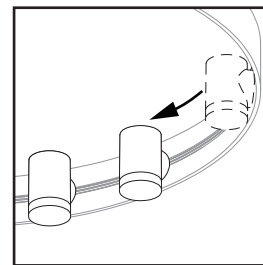

Move
Position on the ARENA as desired to highlight areas below or create a visual pattern

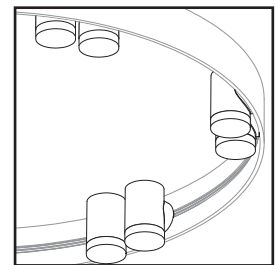

Group
Place together to concentrate light in areas along the ARENA

SPECIFICATIONS

8291

LIGHT SOURCE
DELIVERED LUMENS
CRI
MAX UNITS
OPTIC
HEATSINK
DIMMING
WARRANTY
WEIGHT

COB type LED (7W DC Load)
937lm (COLOR: 4000K, BEAM ANGLE: MED [26°], LENS: FRO)
85 CRI Typical
Total DC load of installed light sources (8290, 8291, 8292, 8293-36, 8293-54) must not exceed 100w.
Machined clear acrylic with a frosted inner finish
Die-cast aluminum with a fine textured powder coat finish
0-10V dimming (DV)
5 years
0.70lbs/320g per unit



EUREKA

225 de Liège Ouest, Suite #200
Montréal (QC), Canada H2P 1H4
Tel : 514.385.3515 Fax : 514.385.4169
www.eurekalighting.com



8291

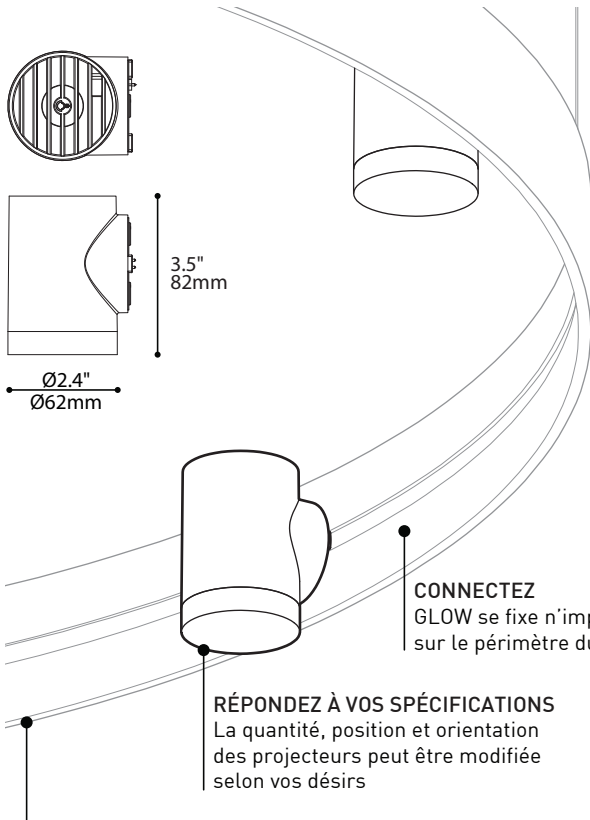

CONNECTEZ
GLOW se fixe n'importe où sur le périmètre du ARENA

RÉPONDEZ À VOS SPÉCIFICATIONS
La quantité, position et orientation des projecteurs peut être modifiée selon vos désirs

ARENA (8200) REQUIS (VENDU SÉPARÉMENT)

UNE DOUCE LUEUR

Muni d'un épais diffuseur cristallin, le GLOW ajoute une touche de luxe au majestueux profil du ARENA (8200) vendu séparément. Il peut être déplacé, dirigé vers le haut ou le bas, pivoté de gauche à droite sans aucun outil

DISSIPATEUR EN ALUMINIUM
Conçu sur mesure pour une dissipation thermique optimale. Offert en finis finement texturés noir ou blanc

DEL COB HAUTE PUISSANCE
Source unique efficace et haute performance

RÉFLECTEUR COMPACT
Réflecteur fini aluminium pour une sortie efficace de la lumière

DIFFUSEUR SOLIDE
Taillé dans l'acrylique tel un bijou, un diffuseur clair à l'extérieur et givré à l'intérieur

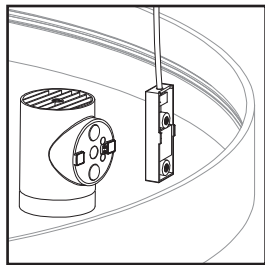
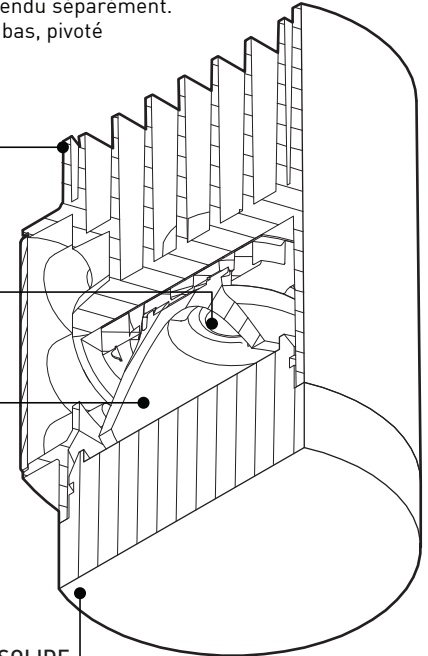

Attachez
Sécurisé par de puissants aimants en néodyme. Testé selon UL pour supporter plusieurs fois leur poids

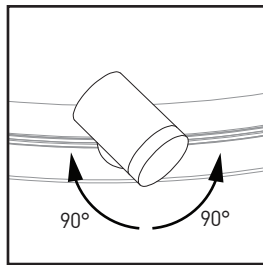

Pivotez
GLOW peut être tourné 90° sur le côté dans chaque direction afin d'illuminer une zone ou un objet particulier

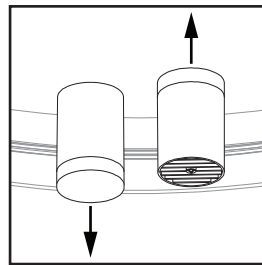

Inversez
GLOW peut être tourné vers le haut ou le bas pour une illumination directe ou indirecte

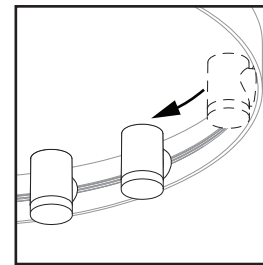

Déplacez
Positionnez sur le ARENA tel que désiré afin d'illuminer des zones sous le luminaire ou créer des motifs visuels

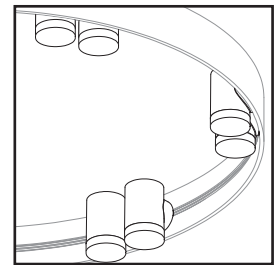

Groupez
Placez ensemble afin de concentrer des zones de lumière le long du ARENA

SPÉCIFICATIONS

8291

SOURCE LUMINEUSE

DEL de type COB (Charge DC 7W)

LUMENS RÉELS

937lm (COULEUR: 4000K, ANGLE DE FAISSEAU: MED (26°), LENTILLE: FRO)

IRC

85 CRI typique

UNITÉS MAXIMUM

Puissance DC totale des sources lumineuses installées (8290, 8291, 8292, 8293-36, 8293-54) ne doit pas dépasser 100w.

OPTIQUES

Acrylique claire usiné avec un fini intérieur givré

DISSIPATEUR THERMIQUE

Aluminium coulé sous pression avec un fini en poudre finement texturé

GRADATION

Gradation 0-10V (DV)

GARANTIE

5 ans

POIDS

0.70lbs/320g par unité



EUREKA

225 de Liège Ouest, Suite #200
Montréal (QC), Canada H2P 1H4
Tel : 514.385.3515 Fax : 514.385.4169
www.eurekalighting.com



8291

Configure Arena in two easy steps

1

Choose your **Arena** options

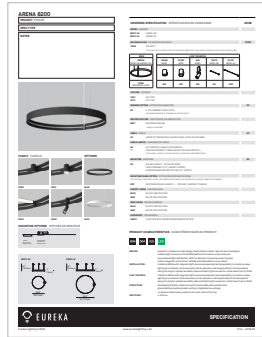

2

Configure **light sources** as needed

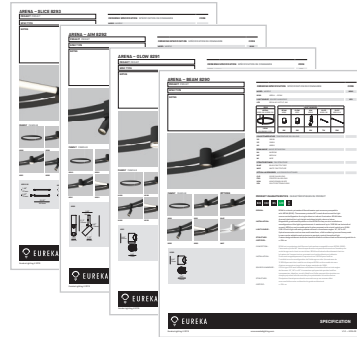

Our favorites



1 × ARENA 54"
6 × ARENA - AIM



1 × ARENA 54"
12 × ARENA - BEAM



1 × ARENA 54"
12 × ARENA - GLOW



1 × ARENA 54"
4 × ARENA - SLICE 54"

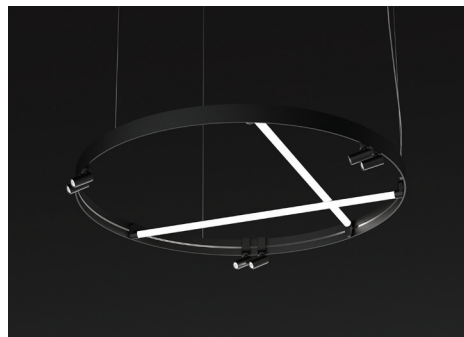

1 × ARENA 54"
2 × ARENA - SLICE 54"
6 × ARENA - AIM



1 × ARENA 54"
2 × ARENA - SLICE 54"
2 × ARENA - GLOW

ARENA 8200

PROJECT PROJÉT
SPEC TYPE
NOTES

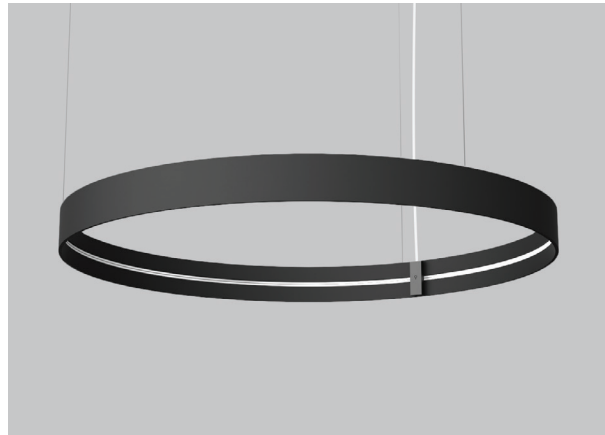

FAMILY FAMILLE



FINISH FINI

MOUNTING OPTIONS OPTIONS DE MONTAGE

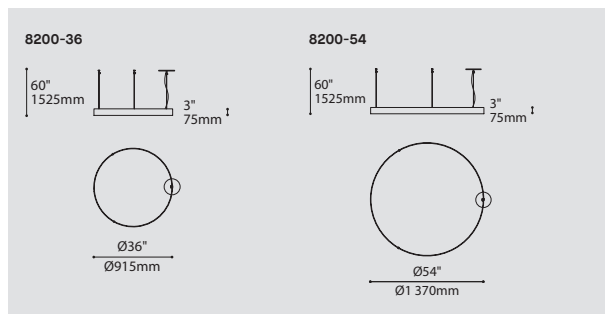
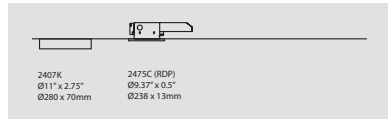

ORDERING SPECIFICATION SPÉCIFICATION DE COMMANDE

CODE

MODEL MODÈLE

8200-36 ARENA 36"
8200-54 ARENA 54"

MAXIMUM DC LOAD PUISSANCE MAXIMALE DC

100W 100 WATT DC
TOTAL DC LOAD OF INSTALLED LIGHT SOURCES (8290, 8291, 8292, 8293-36, 8293-54) MUST NOT EXCEED 100W.

RING
ARENA 8200-36 & 8200-54
MAXIMUM DC LOAD 100W

LIGHT SOURCES				
BEAM 8290	GLOW 8291	AIM 8292	SLICE 8293-36	SLICE 8293-54
7W DC	7W DC	7W DC	6W DC	9W DC

VOLTAGE VOLTAGE

120V 120 VOLT
277V 277 VOLT

DIMMING OPTION OPTION DE GRADATION

DV 0-10V DIMMING (120V-277V)
LED DIMMING DRIVER IS STANDARD IN THIS PRODUCT

DRIVER POSITION POSITION DE L'ALIMENTATION

RDP * RECESSED DRIVER
* 3981C IS REQUIRED

CABLE CÂBLE

AC AIRCRAFT MOUNTING & CLEAR CABLE, FIELD ADJUSTABLE

CABLE LENGTH LONGUEUR DE CÂBLE

60 60" AIRCRAFT CABLE (STD LENGTH)
** CUSTOM AIRCRAFT CABLE LENGTH (PLEASE SPECIFY)
FOR OVERALL LENGTH, PLEASE CONTACT YOUR EUREKA REPRESENTATIVE.

MOUNTING MONTAGE

RC ROUND CANOPY / PAVILLON ROND
FOR STANDARD: 2.75" CANOPY (2407K)
FOR RECESSED DRIVER OPTION: 0.5" (2475C)

MOUNTING CABLE OPTION OPTION DE MONTAGE DE CÂBLE

IF NO OPTION IS SELECTED, AN OFF-CENTERED ROUND CANOPY WITH STRAIGHT AIRCRAFT CABLES IS STANDARD

RCC CENTERED ROUND CANOPY - STRAIGHT AIRCRAFT CABLES

CANOPY FINISH FINI PAVILLON

BLKE BLACK FINE TEXTURE
WHE WHITE FINE TEXTURE

RING FINISH FINI DE L'ANNEAU

BLKE BLACK FINE TEXTURE
WHE WHITE FINE TEXTURE

ACCESSORY ACCESSOIRE

3981C JUNCTION BOX FOR RECESSED DRIVER OPTION

PRODUCT CHARACTERISTICS CARACTÉRISTIQUES DU PRODUIT



- DESIGN:** Authentic, timeless circular design meets today's needs. Specify and reconfigure multiple light sources on the ARENA platform to create a unique look and personalized light distribution. With its discreet, innovative power ring and instant magnetic connections, ARENA puts illumination in your hands.
- INSTALLATION:** Combine ARENA with magnetic light source accessories (sold separately) to create a unique lighting environment. All accessories can be placed or rearranged without tools anywhere along the ring for optimal versatility. Mix and match light sources for a total load of up to 100W.
- LIGHT SOURCE:** Combine ARENA with magnetic light source accessories (sold separately) to create a unique lighting environment. All accessories can be placed or rearranged without tools anywhere along the ring for optimal versatility. Mix and match light sources for a total load of up to 100W.
- STRUCTURE:** Seamlessly finished, rolled concentric steel profile with architectural grade matte polyester powder coating. Integrated low-voltage conductor meticulously joined on the inner side of the ring.
- CERTIFIED:** c-CSA-us

EVOLVING LIGHT

ARENA is the circular base profile that supports and powers a variety of compatible light sources which can be combined and positioned as desired.

The ARENA will accommodate a choice of light sources which can be customized in quantity, position, orientation and combinations to provide users with a tailored solution for their space.

RELOCATE

Easily relocated power feed to anywhere around the ring for flexibility in canopy locations

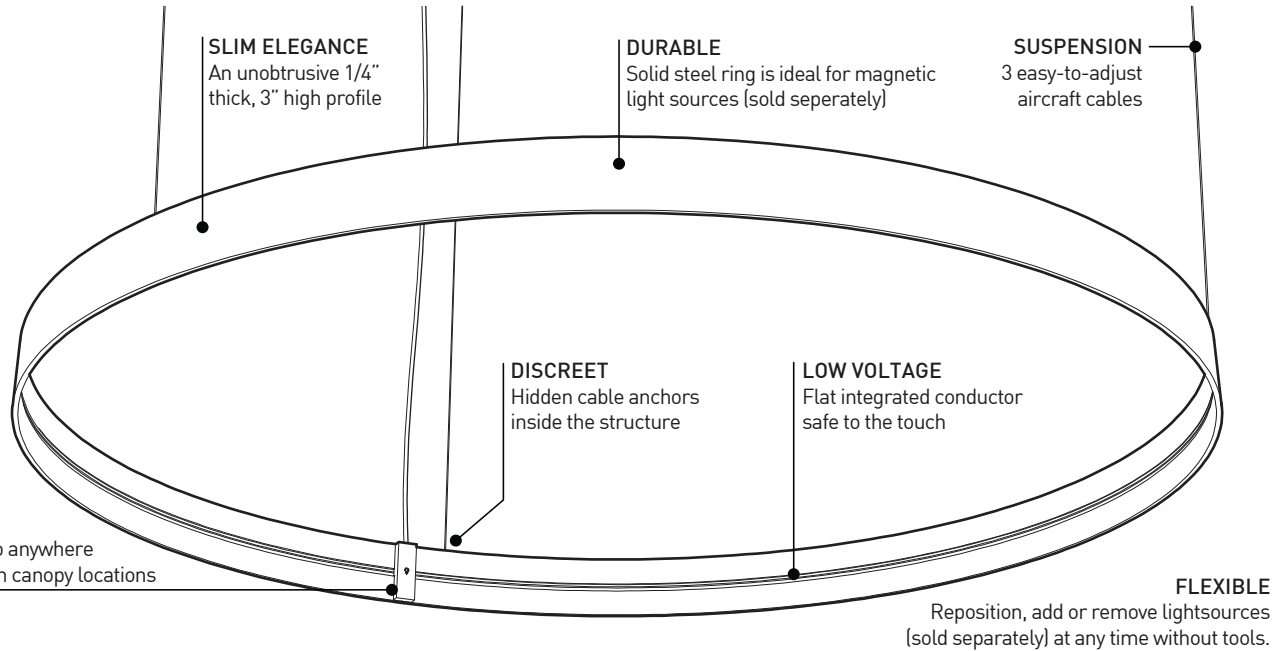

SIZES

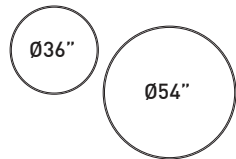

2 sizes Allow multiple combinations for a variety of spaces

CANOPY POSITION

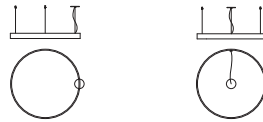

Standard (fixed location)
Centered with mounting point

RCC (flexible location)
Independent from the mounting point

CANOPY TYPE

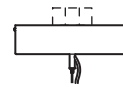

STANDARD CANOPY 11\"X2.75\"
Mounting on a 4\" standard j-box

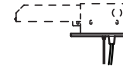

LOW PROFILE CANOPY 9.4\"X0.25\"
Mounting on Eureka box 3981C (sold separately, can be shipped and installed in advance)
Recessed driver for discreet installation
Min. 3.5\" inside ceiling clearance required

LIGHT SOURCES :

Several light source accessories are available for ARENA. They are sold separately in the quantity and type desired. Different types can be combined

Please refer to their individual product pages for more information

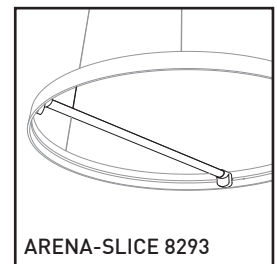
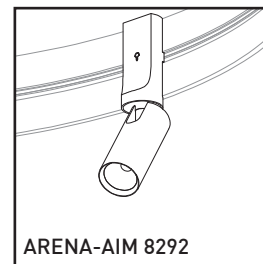
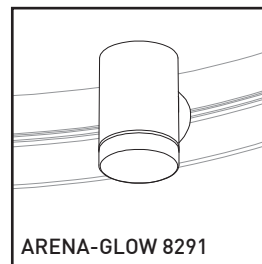
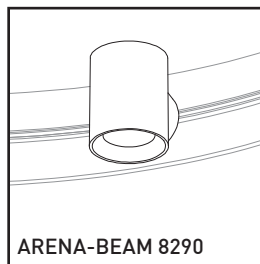

SPECIFICATIONS

STRUCTURE

LIGHT SOURCES

POWER

VOLTAGE

DIMMING

WARRANTY

WEIGHT

8200-36

Cold rolled steel formed, polished with a powder coat finish

Sold separately. Please refer to light sources 8290, 8291, 8292, 8293

Max AC power consumption 120W / Max 100W DC load of installed light sources (8290, 8291, 8292, 8293-36, 8293-54)

120V or 277V

0-10V dimming (DV)

5 years

24lbs (10.9kg), Max 34.6lbs (15.7kg) with 12 Light sources

8200-54

40lbs (18.2kg), Max 52.2lbs (23.7kg) with 12 Light sources

LUMIÈRE ÉVOLUTIVE

ARENA est la base circulaire qui supporte et alimente une variété de sources lumineuses compatibles pouvant être combinées et positionnées selon vos désirs

ARENA accommodera un choix de sources lumineuses pouvant être personnalisées en quantité, position, orientation et combinaison afin de permettre à l'utilisateur une solution adaptée à l'espace

RELOCALISEZ

Source d'alimentation amovible pouvant être relocalisée sur l'anneau afin d'accommoder la localisation du pavillon

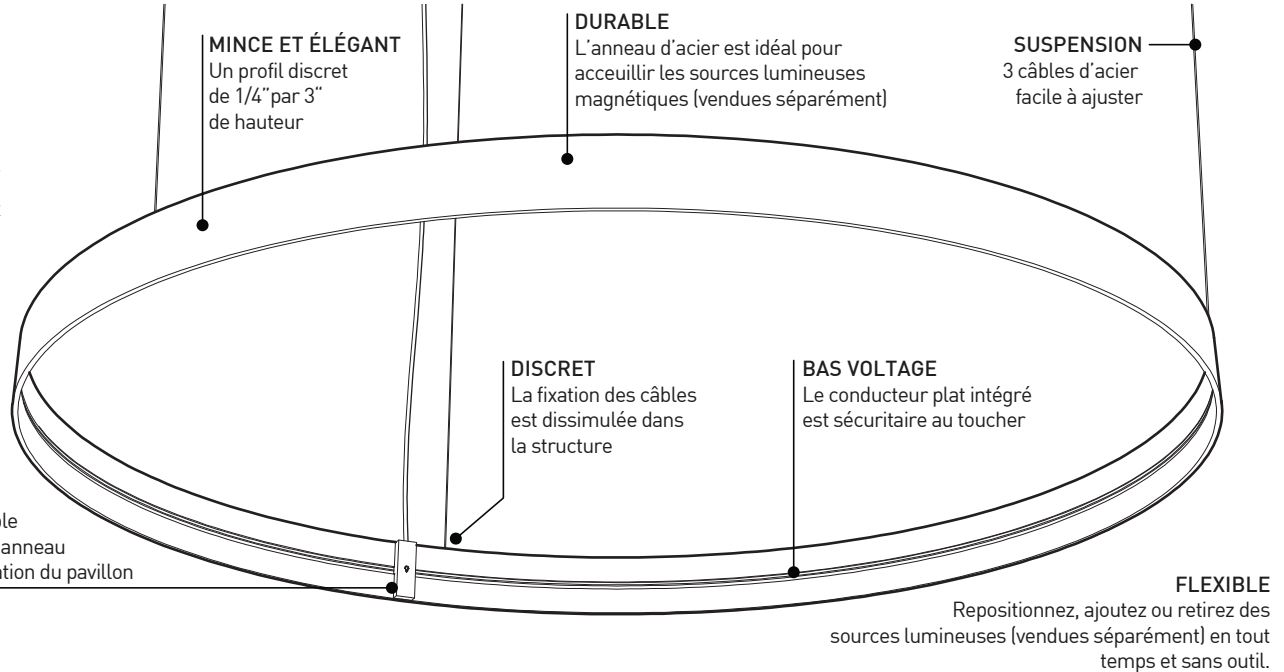

TAILLES

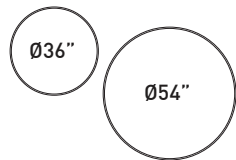

2 tailles
Permettent une multitude de combinaisons pour une variété d'espaces.

POSITION DU PAVILLON



Standard (location fixe)
Centré avec un point de montage

RCC (location flexible)
Indépendant du point de montage

TYPE DE PAVILLON

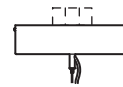

PAVILLON STANDARD 11"X2.75"
Installation sur une boîte de jonction 4" standard

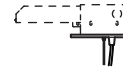

PAVILLON BAS PROFILE 9.4"X0.25"
Installation sur une boîte Eureka 3981C (vendue séparément, peut être livrée séparément pour une installation en avance)
Pilote encastré pour installation discrète
Jeu de 3.5" minimum dans le plafond requis

SOURCES LUMINEUSES :

Plusieurs accessoires lumineux sont disponibles pour ARENA. Vendues séparément dans la quantité et le type désiré. Les modèles peuvent être combinés

Se référer aux pages individuelles des produits pour plus d'informations

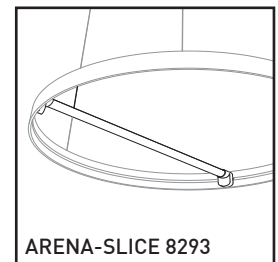
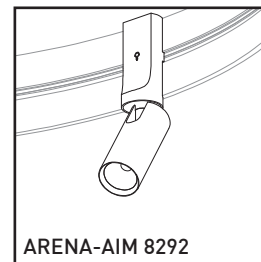
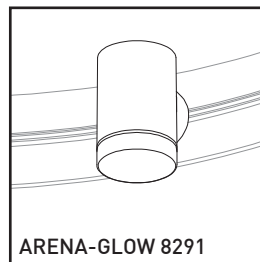
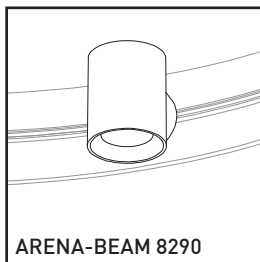

SPÉCIFICATIONS

STRUCTURE

SOURCE LUMINEUSE

PUISSANCE TOTALE

VOLTAGE

GRADATION

GARANTIE

POIDS

8200-36

8200-54

Acier roulé à froid, fini avec un revêtement en poudre

Vendues séparément. Veuillez vous référer aux sources lumineuses 8290, 8291, 8292, 8293

Consommation max AC 120W / Max 100W DC des sources lumineuses installées (8290, 8291, 8292, 8293-36, 8293-54)

120V or 277V

Gradation 0-10V (DV)

5 ans

24lb (10.9kg), Max 34.6lb (15.7kg) avec 12 sources lumineuses

40lb (18.2kg), Max 52.2lb (23.7kg) avec 12 sources lumineuses