

# ARENA – BEAM 8290

PROJECT PROJET
SPEC TYPE
NOTES

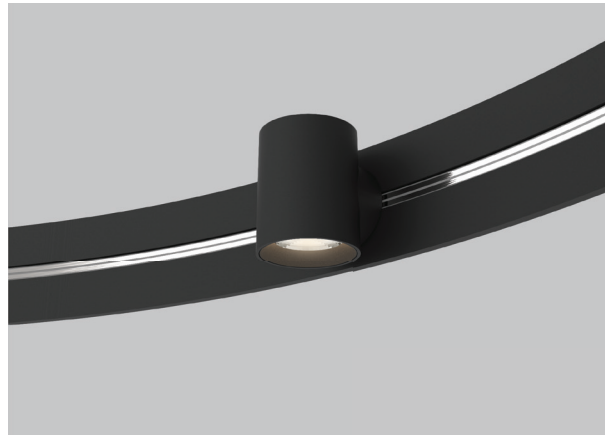

## FAMILY FAMILLE



## FINISH FINI

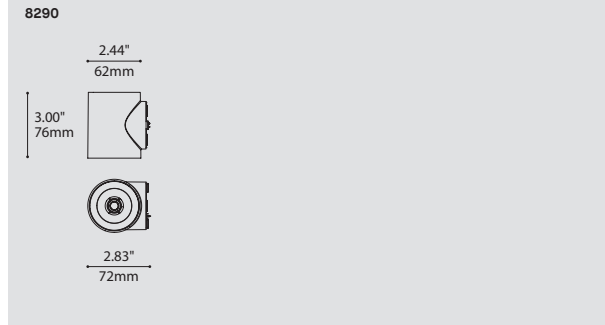

## ORDERING SPECIFICATION SPÉCIFICATION DE COMMANDE

MODEL MODÈLE	CODE
8290 ARENA – BEAM* *ARENA – BEAM IS AN ACCESSORY LIGHT SOURCE USED WITH ARENA 8200 (SOLD SEPARATELY)	8290
LIGHT SOURCE SOURCE LUMINEUSE	LED
LED REGULAR OUTPUT, 7W TOTAL DC LOAD OF INSTALLED LIGHT SOURCES (8290, 8291, 8292, 8293-36, 8293-54) MUST NOT EXCEED 100W.	
COLOR TEMPERATURE TEMPÉRATURE DE COULEUR	
30 3000K	
35 3500K	
40 4000K	
BEAM ANGLE ANGLE DE FAISCEAU	
NA NARROW (16°)	
ME MEDIUM (26°)	
WI WIDE (45°)	
STRUCTURE FINISH FINI STRUCTURE	
BLKE BLACK FINE TEXTURE	
WHE WHITE FINE TEXTURE	
OPTICAL ACCESSORIES ACCESSOIRES OPTIQUES	
CLR CLEAR GLASS LENS	
FRO FROSTED GLASS LENS	
HON HONEYCOMB LOUVER	
SOL SOLITE SOFTENING LENS	

## PRODUCT CHARACTERISTICS CARACTÉRISTIQUES DU PRODUIT



- DESIGN:** ARENA – BEAM is a classic yet modern 62mm diameter spot accessory for ARENA (8200). The accessory rotates 90° in each direction and the light source can be flipped on the ring for direct or indirect illumination. ARENA – BEAM hides discreetly behind the ring's height and shines brightly above or below.
- INSTALLATION:** Magnetically positioned anywhere on the ARENA for easy on-site installation or reconfiguration of the lighting environment. A maximum of up to 12 ARENA – BEAM can be installed on each ARENA or can be combined with other accessories for a total load of up to 100W.
- LIGHT SOURCE:** COB LED with light collimating reflector offered in three beam angles: 16°, 26° or 45°. Optical accessories such as clear and frosted lens, a Solite softening lens and honeycomb louvers can be added to each projector to precisely control the emitted light.
- STRUCTURE:** Custom designed diecast aluminum heatsink offered in white or black architectural grade finish.
- CERTIFIED:** c-CSA-us
- CONCEPTION:** ARENA – BEAM est un projecteur de 62mm au look moderne pour ARENA (8200). L'accessoire pivote 90° dans chaque direction et peut être inversé sur l'anneau pour un éclairage vers le haut ou vers le bas. ARENA – BEAM se dissimule discrètement derrière la hauteur de l'anneau tout en procurant une lumière directe ou indirecte.
- INSTALLATION:** Positionné magnétiquement n'importe où sur l'ARENA pour faciliter l'installation ou la reconfiguration de l'éclairage sur site. Un maximum de 12 ARENA – BEAM peuvent être installés sur chaque ARENA ou être combinés avec d'autres accessoires jusqu'à une charge maximale de 100W.
- SOURCE LUMINEUSE:** LED de type COB avec réflecteur collimateur de lumière offert en trois angles de faisceau: 16°, 26° ou 45°. Accessoires optiques tels que des lentilles transparentes, dépolies, en nid d'abeille ou Solite peuvent être ajoutées sur chaque projecteur afin de contrôler plus précisément la lumière émise.
- STRUCTURE:** Dissipateur thermique en aluminium moulé conçu sur mesure offert avec une finition noire ou blanche de grade architectural.
- CERTIFIÉ:** c-CSA-us

## REFERENCE CHART TABLEAU DE RÉFÉRENCE

RING	LIGHT SOURCES				
ARENA 8200-36 & 8200-54	BEAM 8290	GLOW 8291	AIM 8292	SLICE 8293-36	SLICE 8293-54
MAXIMUM DC LOAD 100W	7W DC	7W DC	7W DC	6W DC	9W DC

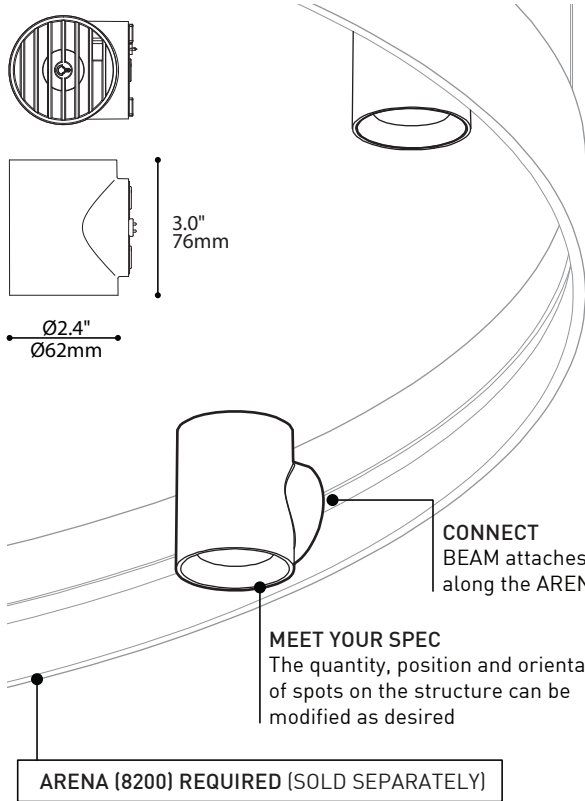

### A VERSATILE, ELEGANT SPOT

BEAM is a classic yet modern 62mm diameter spot accessory compatible with ARENA (8200) ring profile (sold separately). It hides discreetly behind the ring's height and shines brightly above or below

**DIE-CAST ALUMINUM HEATSINK**  
Custom designed for optimal heat dissipation, black or white textured finish

**HIGH POWER COB LED**  
Single point source with high performance efficiency

**COMPACT REFLECTOR**  
Narrow (16°), Medium (26°) or Wide (45°) FWHM beam angle

**OPTICAL ACCESSORIES**  
A choice of clear, frosted or Solite lenses or honeycomb louver. Compatible with other 1/8" x 2" (3x50mm) lenses

**BAFFLE**  
For wide angle glare control

**CONNECT**  
BEAM attaches anywhere along the ARENA structure

**MEET YOUR SPEC**  
The quantity, position and orientation of spots on the structure can be modified as desired

ARENA (8200) REQUIRED (SOLD SEPARATELY)

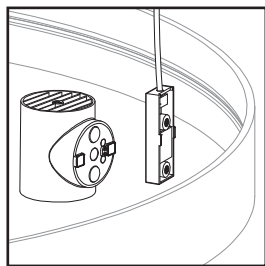

**Attach**  
Secured by strong neodymium magnets. Tested to UL standards to support several times its weight

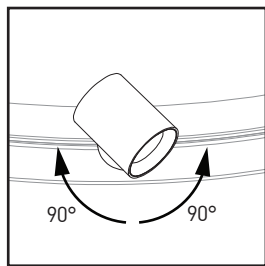

**Rotate**  
BEAM can be rotated sideways up to 90° in each direction to help highlight a particular area or object

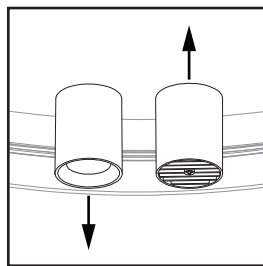

**Flip**  
BEAM can be flipped up or down for direct or indirect illumination

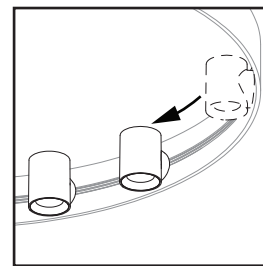

**Move**  
Position on the ARENA as desired to highlight areas below or create a visual pattern

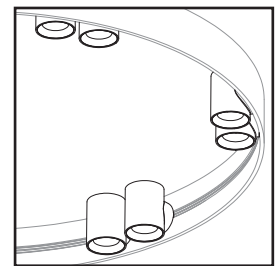

**Group**  
Place together to concentrate light in areas along the ARENA

## SPECIFICATIONS

### 8290

LIGHT SOURCE	COB type LED (7W DC Load)
DELIVERED LUMENS	888lm (COLOR: 4000K, BEAM ANGLE: MED (26°), LENS: CLR) / 840lm (COLOR: 4000K, BEAM ANGLE: MED (45°), LENS: FRO)
CRI	85 CRI typical
MAX UNITS REFLECTOR	Total DC load of installed light sources (8290, 8291, 8292, 8293-36, 8293-54) must not exceed 100w.
LENS ACCESSORIES	Narrow 16°, Medium 26°, Wide 45° FWHM beam angle
HEATSINK	Clear (1930), Frosted (1931), Solite softening lens (1932) or Honeycomb louver (1935) can be specified.
DIMMING	Die-cast aluminum with a fine textured powder coat finish
WARRANTY	0-10V dimming (DV)
WEIGHT	5 years
	0.62lbs/285g per unit

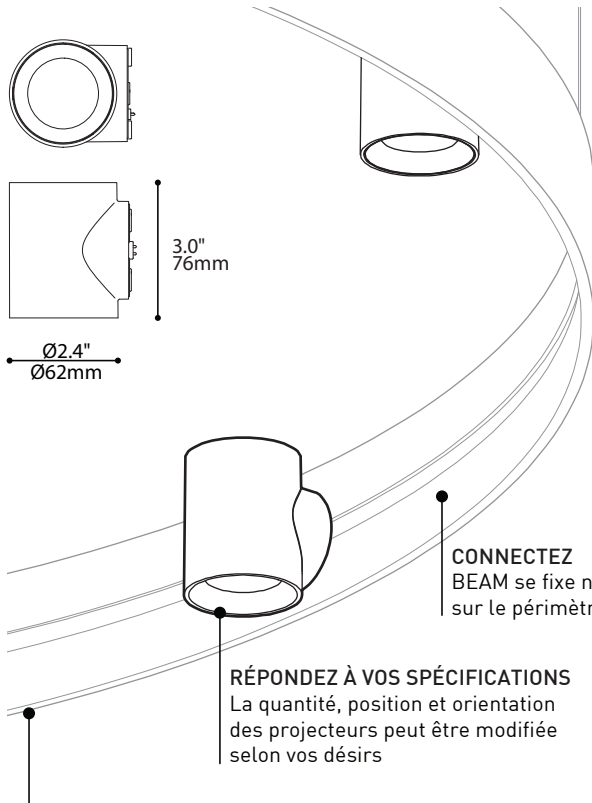

### UN PROJECTEUR ÉLÉGANT ET VERSATILE

BEAM est un projecteur moderne de 60mm de diamètre, compatible avec ARENA (8200) vendu séparément. Il se dissimule discrètement derrière la hauteur de l'anneau et brille avec éclat au dessus ou au dessous de celui-ci

**DISSIPATEUR EN ALUMINUM**  
Conçu sur mesure pour une dissipation thermique optimale. Offert en finis finement texturés noir ou blanc

**DEL COB HAUTE PUISSANCE**  
Source unique efficace et haute performance

**RÉFLECTEUR COMPACT**  
Angle de faisceau Étroit (16°), Medium (26°) ou Large (45°) FWHM

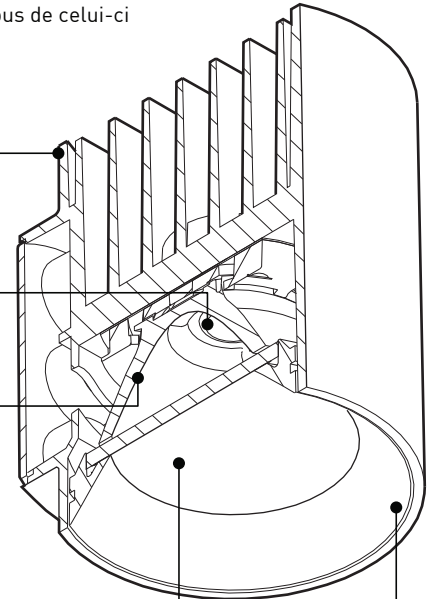

**ACCESSOIRES OPTIQUES**  
Un choix de lentilles claire, givrée ou Solite, ou grille en nid d'abeille. Compatible avec d'autre lentille 1/8" x 2" (3x50mm)

**DÉFLECTEUR**  
Pour un contrôle de l'éblouissement

**ARENA (8200) REQUIS (VENDU SÉPARÉMENT)**

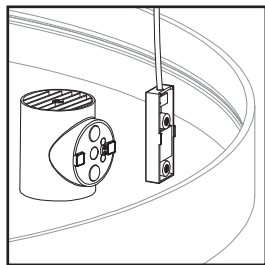

**Attachez**  
Sécurisé par de puissants aimants en néodyme. Testé selon UL pour supporter plusieurs fois leur poids

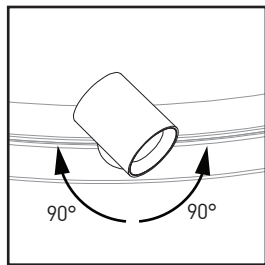

**Pivotez**  
BEAM peut être tourné 90° sur le coté dans chaque direction afin d'illuminer une zone ou un objet particulier

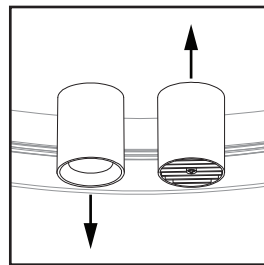

**Inversez**  
BEAM peut être tourné vers le haut ou le bas pour une illumination directe ou indirecte

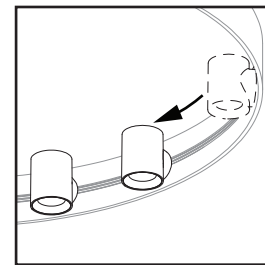

**Déplacez**  
Positionnez sur le ARENA tel que désiré afin d'illuminer des zones sous le luminaire ou créer des motifs visuels

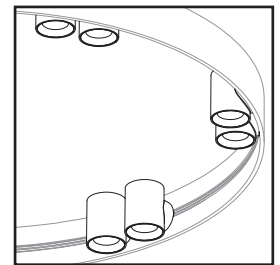

**Groupez**  
Placez ensemble afin de concentrer des zones de lumière le long du ARENA

## SPÉCIFICATIONS

### 8290

SOURCE LUMINEUSE  
LUMENS RÉELS  
IRC  
UNITÉS MAXIMUM  
RÉFLECTEUR  
LENTILLES ACCESSOIRES  
DISSIPATEUR THERMIQUE  
GRADATION  
GARANTIE  
POIDS

DEL de type COB [Charge DC 7W]  
888lm [COULEUR: 4000K, FAISEAU: MED [26°], LENTILLE: CLR] / 840lm [COULEUR: 4000K, FAISEAU: WIDE [45°], LENTILLE: FRO]  
85 CRI typique  
Puissance DC totale des sources lumineuses installées [8290, 8291, 8292, 8293-36, 8293-54] ne doit pas dépasser 100w.  
Angle de faisceau (FWHM): Étroit 16°, Moyen 26°, Large 45°  
Claire [1930], Givrée [1931], Lentille adoucissante Solite [1932] or Grille en nid d'abeille [1935] peut être spécifié  
Aluminium coulé sous pression avec un fini en poudre finement texturé  
Gradation 0-10V [DV]  
5 ans  
0.62lbs/285g par unité

# Configure Arena in two easy steps

1

Choose your **Arena** options

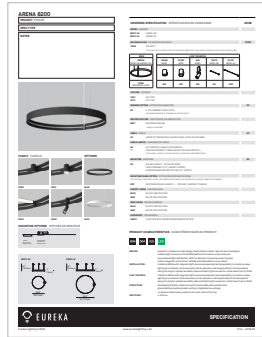

2

Configure **light sources** as needed

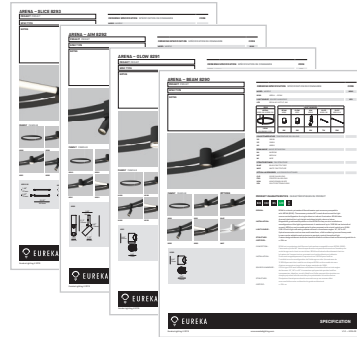

## Our favorites



1 × ARENA 54"  
6 × ARENA - AIM



1 × ARENA 54"  
12 × ARENA - BEAM



1 × ARENA 54"  
12 × ARENA - GLOW



1 × ARENA 54"  
4 × ARENA - SLICE 54"

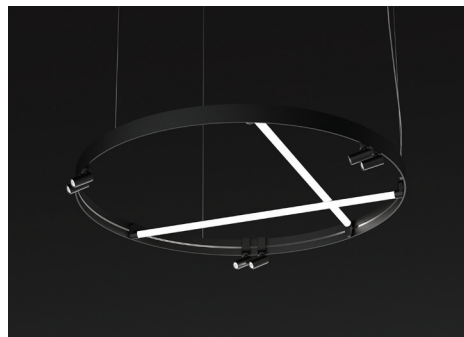

1 × ARENA 54"  
2 × ARENA - SLICE 54"  
6 × ARENA - AIM



1 × ARENA 54"  
2 × ARENA - SLICE 54"  
2 × ARENA - GLOW

# ARENA 8200

PROJECT PROJÉT
SPEC TYPE
NOTES

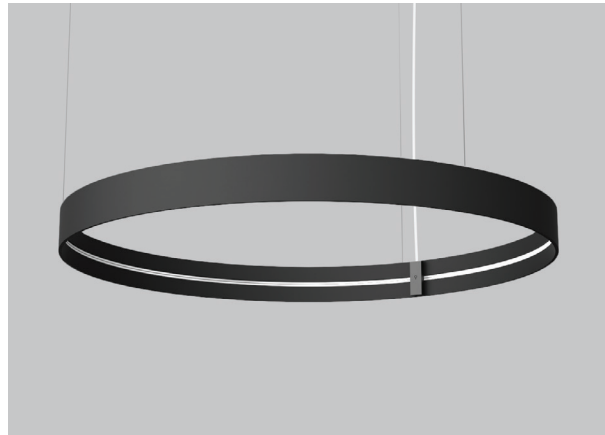

## FAMILY FAMILLE



## FINISH FINI



## MOUNTING OPTIONS OPTIONS DE MONTAGE

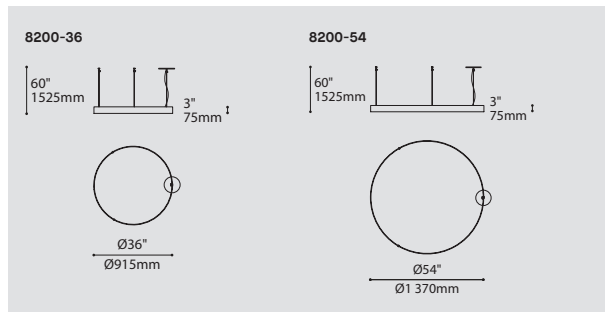
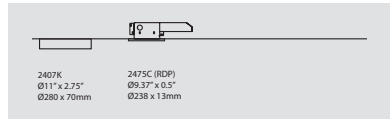

## ORDERING SPECIFICATION SPÉCIFICATION DE COMMANDE

CODE

### MODEL MODÈLE

8200-36 ARENA 36"  
8200-54 ARENA 54"

### MAXIMUM DC LOAD PUISSANCE MAXIMALE DC

100W 100 WATT DC  
TOTAL DC LOAD OF INSTALLED LIGHT SOURCES (8290, 8291, 8292, 8293-36, 8293-54) MUST NOT EXCEED 100W.

RING
ARENA 8200-36 & 8200-54
MAXIMUM DC LOAD 100W

LIGHT SOURCES				
BEAM 8290	GLOW 8291	AIM 8292	SLICE 8293-36	SLICE 8293-54
7W DC	7W DC	7W DC	6W DC	9W DC

### VOLTAGE VOLTAGE

120V 120 VOLT  
277V 277 VOLT

### DIMMING OPTION OPTION DE GRADATION

DV 0-10V DIMMING (120V-277V)  
LED DIMMING DRIVER IS STANDARD IN THIS PRODUCT

### DRIVER POSITION POSITION DE L'ALIMENTATION

RDP \* RECESSED DRIVER  
\* 3981C IS REQUIRED

### CABLE CÂBLE

AC AIRCRAFT MOUNTING & CLEAR CABLE, FIELD ADJUSTABLE

### CABLE LENGTH LONGUEUR DE CÂBLE

60 60" AIRCRAFT CABLE (STD LENGTH)  
\*\* CUSTOM AIRCRAFT CABLE LENGTH (PLEASE SPECIFY)  
FOR OVERALL LENGTH, PLEASE CONTACT YOUR EUREKA REPRESENTATIVE.

### MOUNTING MONTAGE

RC ROUND CANOPY / PAVILLON ROND  
FOR STANDARD: 2.75" CANOPY (2407K)  
FOR RECESSED DRIVER OPTION: 0.5" (2475C)

### MOUNTING CABLE OPTION OPTION DE MONTAGE DE CÂBLE

IF NO OPTION IS SELECTED, AN OFF-CENTERED ROUND CANOPY WITH STRAIGHT AIRCRAFT CABLES IS STANDARD

RCC CENTERED ROUND CANOPY - STRAIGHT AIRCRAFT CABLES

### CANOPY FINISH FINI PAVILLON

BLKE BLACK FINE TEXTURE  
WHE WHITE FINE TEXTURE

### RING FINISH FINI DE L'ANNEAU

BLKE BLACK FINE TEXTURE  
WHE WHITE FINE TEXTURE

### ACCESSORY ACCESSOIRE

3981C JUNCTION BOX FOR RECESSED DRIVER OPTION

## PRODUCT CHARACTERISTICS CARACTÉRISTIQUES DU PRODUIT



- DESIGN:** Authentic, timeless circular design meets today's needs. Specify and reconfigure multiple light sources on the ARENA platform to create a unique look and personalized light distribution. With its discreet, innovative power ring and instant magnetic connections, ARENA puts illumination in your hands.
- INSTALLATION:** Combine ARENA with magnetic light source accessories (sold separately) to create a unique lighting environment. All accessories can be placed or rearranged without tools anywhere along the ring for optimal versatility. Mix and match light sources for a total load of up to 100W.
- LIGHT SOURCE:** Combine ARENA with magnetic light source accessories (sold separately) to create a unique lighting environment. All accessories can be placed or rearranged without tools anywhere along the ring for optimal versatility. Mix and match light sources for a total load of up to 100W.
- STRUCTURE:** Seamlessly finished, rolled concentric steel profile with architectural grade matte polyester powder coating. Integrated low-voltage conductor meticulously joined on the inner side of the ring.
- CERTIFIED:** c-CSA-us



## SPECIFICATION

## EVOLVING LIGHT

ARENA is the circular base profile that supports and powers a variety of compatible light sources which can be combined and positioned as desired.

The ARENA will accommodate a choice of light sources which can be customized in quantity, position, orientation and combinations to provide users with a tailored solution for their space.

## RELOCATE

Easily relocated power feed to anywhere around the ring for flexibility in canopy locations

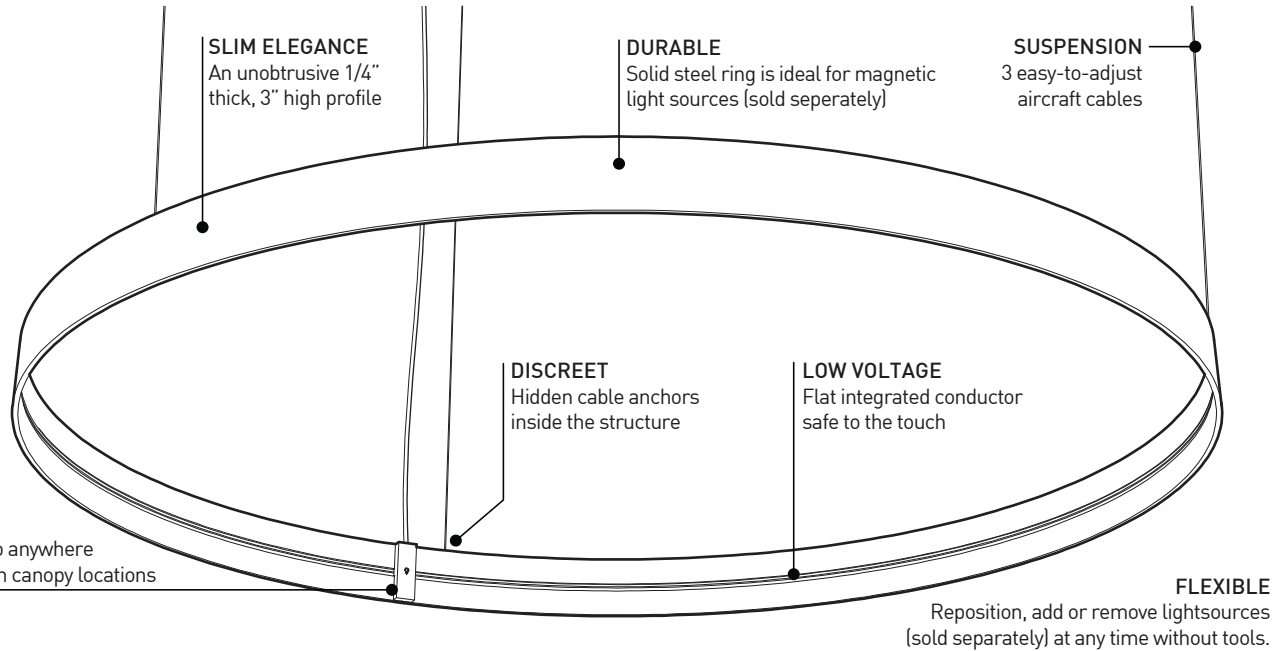

## SIZES

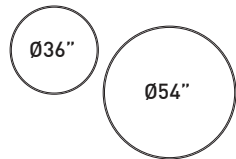

2 sizes Allow multiple combinations for a variety of spaces

## CANOPY POSITION

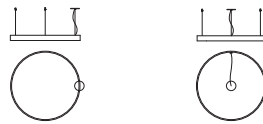

**Standard (fixed location)**  
Centered with mounting point

**RCC (flexible location)**  
Independent from the mounting point

## CANOPY TYPE

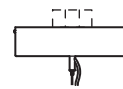

**STANDARD CANOPY 11\"X2.75\"**  
Mounting on a 4\" standard j-box

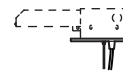

**LOW PROFILE CANOPY 9.4\"X0.25\"**  
Mounting on Eureka box 3981C (**sold separately, can be shipped and installed in advance**)  
Recessed driver for discreet installation  
Min. 3.5\" inside ceiling clearance required

## LIGHT SOURCES :

Several light source accessories are available for ARENA. They are sold separately in the quantity and type desired. Different types can be combined

Please refer to their individual product pages for more information

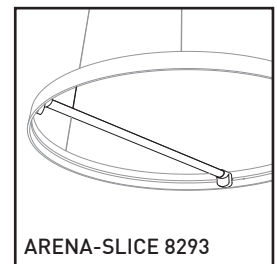
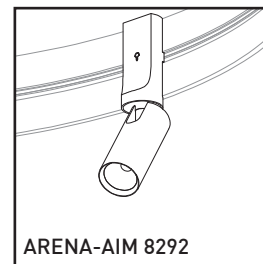
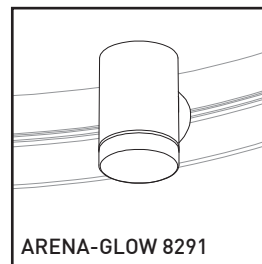
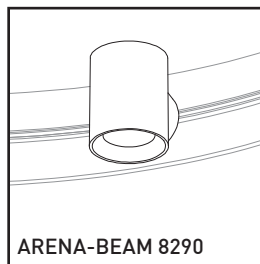

## SPECIFICATIONS

### STRUCTURE

### LIGHT SOURCES

### POWER

### VOLTAGE

### DIMMING

### WARRANTY

### WEIGHT

## 8200-36

Cold rolled steel formed, polished with a powder coat finish

Sold separately. Please refer to light sources 8290, 8291, 8292, 8293

Max AC power consumption 120W / Max 100W DC load of installed light sources (8290, 8291, 8292, 8293-36, 8293-54)

120V or 277V

0-10V dimming (DV)

5 years

24lbs (10.9kg), Max 34.6lbs (15.7kg) with 12 Light sources

## 8200-54

40lbs (18.2kg), Max 52.2lbs (23.7kg) with 12 Light sources



225 de Liège Ouest, Suite #200  
Montréal (QC), Canada H2P 1H4  
Tel : 514.385.3515 Fax : 514.385.4169  
www.eurekalighting.com



**8200-36**  
**8200-54**



## LUMIÈRE ÉVOLUTIVE

ARENA est la base circulaire qui supporte et alimente une variété de sources lumineuses compatibles pouvant être combinées et positionnées selon vos désirs

ARENA accommodera un choix de sources lumineuses pouvant être personnalisées en quantité, position, orientation et combinaison afin de permettre à l'utilisateur une solution adaptée à l'espace

## RELOCALISEZ

Source d'alimentation amovible pouvant être relocalisée sur l'anneau afin d'accommoder la localisation du pavillon

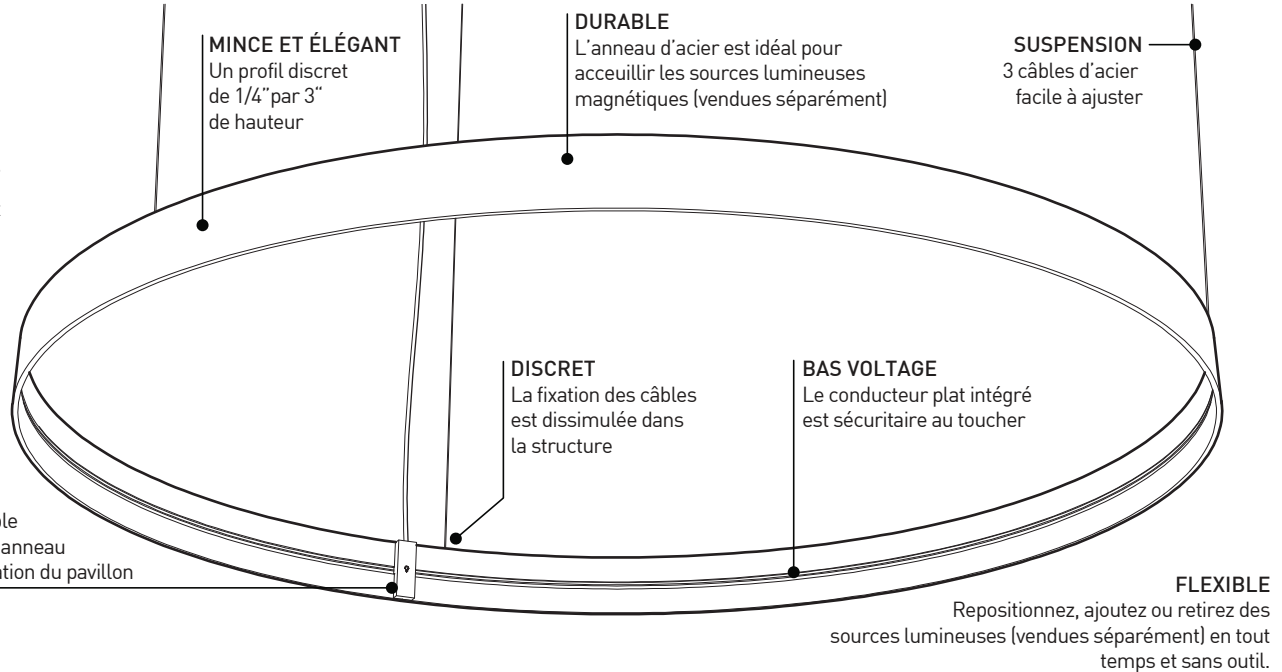

## TAILLES

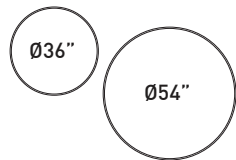

**2 tailles**  
Permettent une multitude de combinaisons pour une variété d'espaces.

## POSITION DU PAVILLON



**Standard (location fixe)**  
Centré avec un point de montage

**RCC (location flexible)**  
Indépendant du point de montage

## TYPE DE PAVILLON

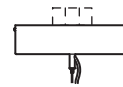

**PAVILLON STANDARD 11"X2.75"**  
Installation sur une boîte de jonction 4" standard

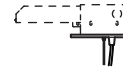

**PAVILLON BAS PROFILE 9.4"X0.25"**  
Installation sur une boîte Eureka 3981C (vendue séparément, peut être livrée séparément pour une installation en avance)  
Pilote encastré pour installation discrète  
Jeu de 3.5" minimum dans le plafond requis

## SOURCES LUMINEUSES :

Plusieurs accessoires lumineux sont disponibles pour ARENA. Vendues séparément dans la quantité et le type désiré. Les modèles peuvent être combinés

Se référer aux pages individuelles des produits pour plus d'informations

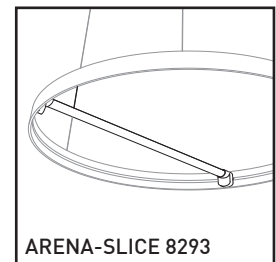
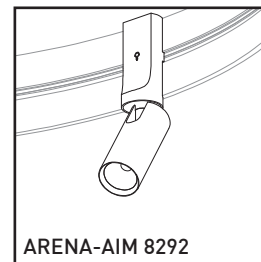
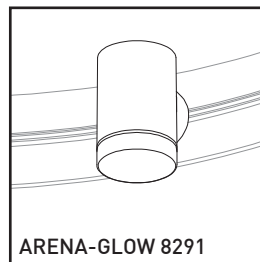
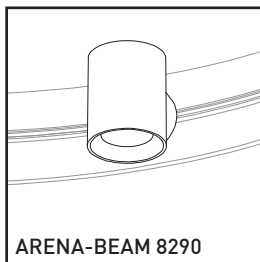

## SPÉCIFICATIONS

### STRUCTURE

### SOURCE LUMINEUSE

### PUISSANCE TOTALE

### VOLTAGE

### GRADATION

### GARANTIE

### POIDS

### 8200-36

Acier roulé à froid, fini avec un revêtement en poudre

Vendues séparément. Veuillez vous référer aux sources lumineuses 8290, 8291, 8292, 8293

Consommation max AC 120W / Max 100W DC des sources lumineuses installées (8290, 8291, 8292, 8293-36, 8293-54)

120V or 277V

Gradation 0-10V (DV)

5 ans

24lb (10.9kg), Max 34.6lb (15.7kg) avec 12 sources lumineuses

### 8200-54

40lb (18.2kg), Max 52.2lb (23.7kg) avec 12 sources lumineuses