

CYCLE LAYERS 4844-2

PROJECT PROJÉT
SPEC TYPE
NOTES

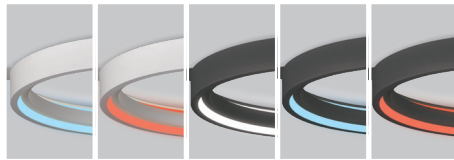

FINISH OPTION FINI COULEUR



WHM-BLU WHM-RED ANTE-WH ANTE-BLU ANTE-RED

FAMILY FAMILLE



3800 (WALL SURFACE) 3800 (CEILING SURFACE) 4800 (CEILING SUSPENDED)

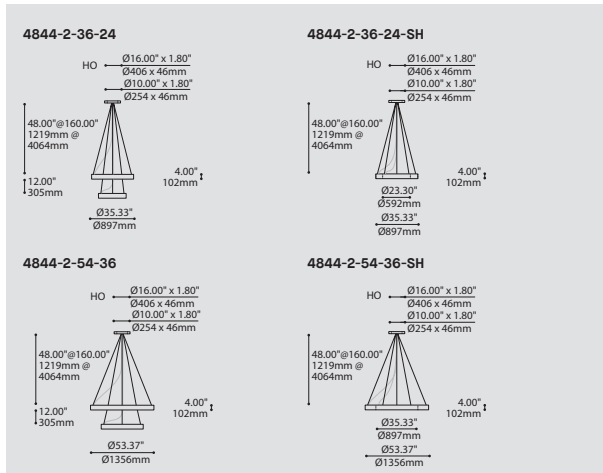

ORDERING SPECIFICATION SPÉCIFICATION DE COMMANDE

MODEL MODÈLE	CODE
4844-2 CYCLE LAYERS - 2 RINGS	4844-2
RINGS DIAMETER DIAMÈTRE D'ANNEAUX	
36-24 TOP RING 36" - BOTTOM RING 24"	
54-36 TOP RING 54" - BOTTOM RING 36"	
LIGHT SOURCE SOURCE LUMINEUSE	LED
(LAMP TYPE)	
LED LED	
COLOR TEMPERATURE TEMPÉRATURE DE COULEUR	
30 3000K	
35 3500K	
40 4000K	
LIGHT SOURCE OPTION - LED OUTPUT OPTION SOURCE LUMINEUSE - SORTIE DEL	
HO HIGH OUTPUT	
VOLTAGE VOLTAGE	
120V 120 VOLT	
277V 277 VOLT	
DIMMING OPTION OPTION DE GRADATION	
DV 0-10V DIMMING (120-277V)	
DP PHASE DIMMING (120V)	
LED DIMMING DRIVER IS STANDARD IN THIS PRODUCT, PLEASE SPECIFY YOUR DIMMING TYPE.	
CABLE CABLE	AC
AC AIRCRAFT MOUNTING & CLEAR CABLE, FIELD ADJUSTABLE	
CABLE LENGTH LONGUEUR DE CABLE (FROM CANOPY TO TOP OF THE FIRST RING)	
60 60" AIRCRAFT CABLE (STD LENGTH)	
** CUSTOM AIRCRAFT CABLE LENGTH FROM 48" TO 160" (PLEASE SPECIFY)*	
ALL DISTANCES BETWEEN RINGS WILL BE 12", EXCEPT IF SAME HEIGHT OPTION IS SELECTED.	
FOR OVERALL LENGTH PLEASE CONTACT YOUR EUREKA REPRESENTATIVE.	
*FOR MAXIMUM MOUNTING DISTANCES SEE REFERENCE PAGE <?>	
SAME HEIGHT RINGS OPTION OPTION D'ANNEAUX DE MÊME HAUTEUR	
SH SAME HEIGHT RING OPTION / OPTION D'ANNEAU À LA MÊME HAUTEUR	
MOUNTING OPTION OPTION DE MONTAGE	
RC ROUND CANOPY / PAVILLON ROND	
FOR STANDARD: 10.00" CANOPY	
FOR HIGH OUTPUT OPTION: 16.00" CANOPY	
CANOPY FINISH FINI PAVILLON	WHM
WHM MATTE WHITE	
RING FINISH FINI ANNEAUX^(A)	
WHM MATTE WHITE	
ANTE ANTHRACITE FINE TEXTURE	
^(A) ALL RINGS FINISHES WILL BE THE SAME	
OPTIONAL INSIDE FINISH OF RINGS FINI INTERNE OPTIONNEL DES ANNEAUX^(A)	
IF NO FINISH IS SELECTED THE INSIDE RING FINISH OF THE EXTERNAL RING WILL BE WHITE	
BLU BLUE	
RED RED	
^(A) ALL INSIDE FINISH OF RINGS WILL BE THE SAME	

PRODUCT CHARACTERISTICS CARACTÉRISTIQUES DU PRODUIT



DESIGN:	The perfectly diffused direct / indirect illumination of Cycle create a luminous halo that fills large spaces with presence and simplicity. Optional blue or red interior finish for a singular colored glow.
STRUCTURE:	Seamlessly finished, rolled concentric aluminum extrusions with highly reflective, white or anthracite polyester powder coating. White canopy with a black recessed center hole.
CERTIFIED:	c-CSA-us
CONCEPTION:	L'éclairage direct / indirect diffus du Cycle créé un halo lumineux occupant l'espace avec simplicité et grandeur. Intérieur bleu ou rouge en option, produisant une lueur colorée singulière.
STRUCTURE:	Structure faite d'extrusions d'aluminium cintrées concentriquement avec finition intérieure à la peinture réfléchissante blanche et finition extérieure offerte en blanc mat ou anthracite finement texturé. Pavillon blanc en acier repoussé avec section centrale noire mate.
CERTIFIÉ:	c-CSA-us



SPECIFICATION



EASY INSTALLATION
Mounts to standard junction box with added mounting points to reinforce installation

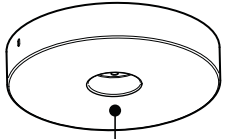

SIMPLE
Chrome plated canopy with plenty of room to house all electrical components for quick assembly

CENTER PIECE
Matte black recessed center hole to hide mounting hardware

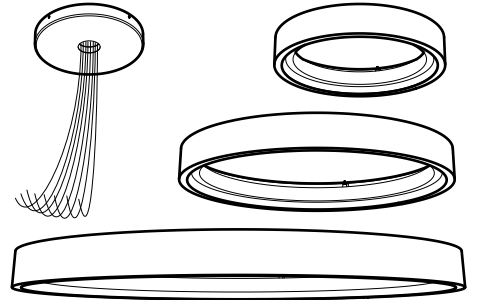

EASY ON-SITE INSTALLATION
Rings can easily be attached to canopy with the help of swivelable grippers and plug & play components

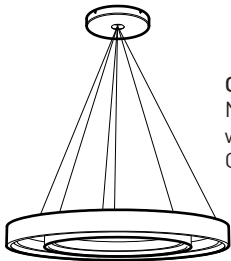

CONFIGURATIONS
Numerous 2 & 3 rings options with different sizes
Color & HO options available

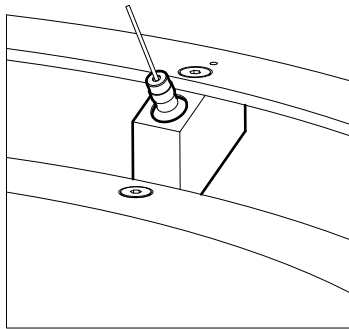
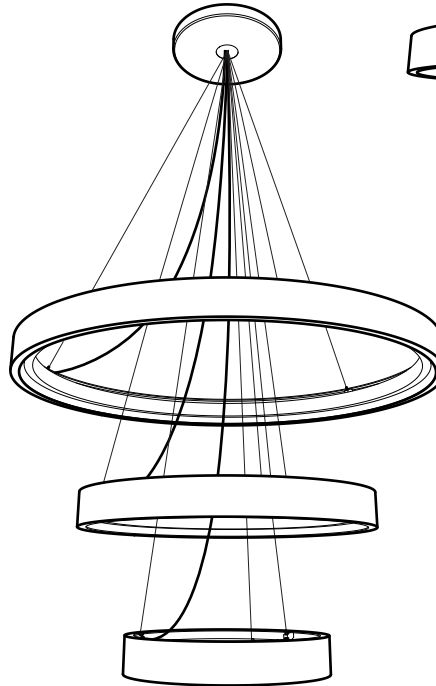

SWIVELABLE GRIPPERS
Integrated in each ring
Facilitate leveling at luminaire height
Locking mechanism to prevent accidental cable re-adjustment

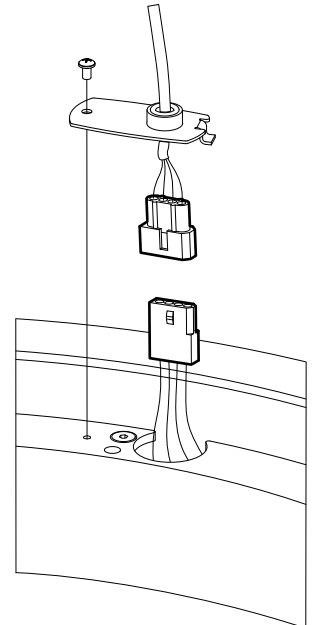

PLUG & PLAY
Simple and fast power feed to each ring
Perfectly concealed afterward

4844-2-36-24-SH
REG / HO
4844-2-54-36-SH
REG / HO

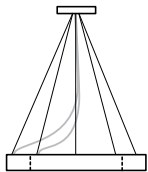

4844-2-36-24
REG / HO
4844-2-54-36
REG / HO

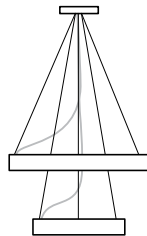

4844-3-36-36-36
REG / HO
4844-3-72-72-72
REG / HO

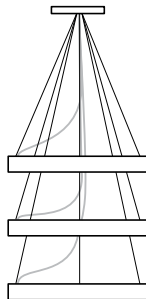

4844-3-54-36-24
REG / HO
4844-3-72-54-36
REG / HO

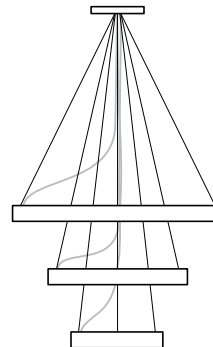

4844-3-36-54-36
REG / HO
4844-3-54-72-54
REG / HO

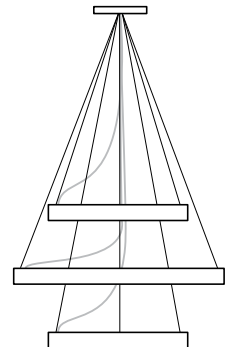



INSTALLATION FACILE
S'installe sur une boîte de jonction standard avec renforcement latéral

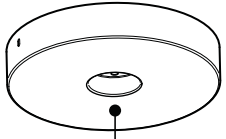

SIMPLE
Pavillon chromé avec espace interne nécessaire pour toutes les composantes électriques pour une installation rapide

PIÈCE CENTRALE
Trou encastré avec finition noire matte pour dissimuler l'installation des câbles

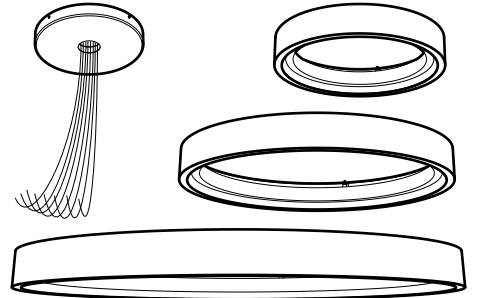

MONTAGE FACILE
Installation par étapes faciles du pavillon et des anneaux séparément

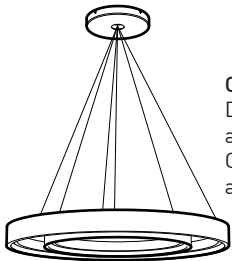

CONFIGURATIONS
De nombreuses options à 2 et 3 anneaux sont possibles
Couleurs et haute performance aussi disponibles

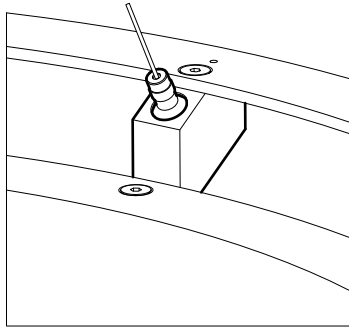
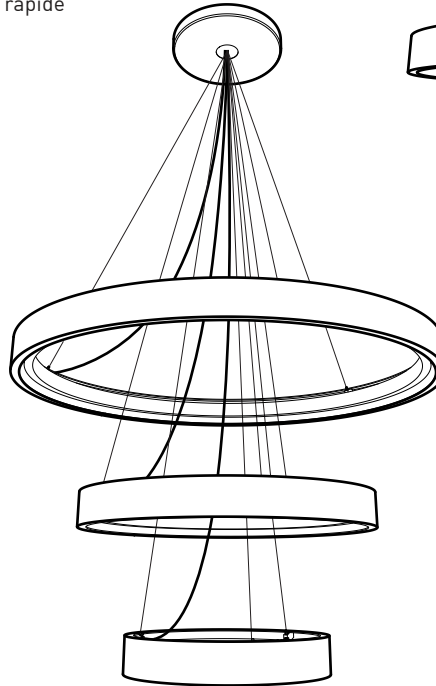

SUPPORT PIVOTANT
Intégré à tous les anneaux
Facilite le nivellement au niveau du luminaire
Mécanisme de blocage pour éviter le désajustement des câbles

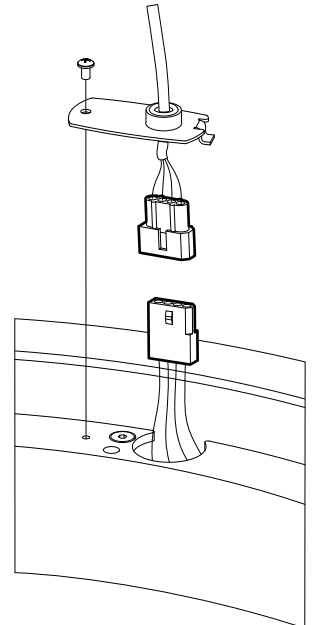

BRANCHEMENT RAPIDE
Simple branchement de chacun des anneaux
Parfaitement dissimulé par la suite

4844-2-36-24-SH
REG / HO
4844-2-54-36-SH
REG / HO

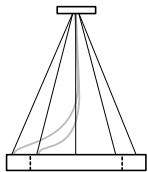

4844-2-36-24
REG / HO
4844-2-54-36
REG / HO

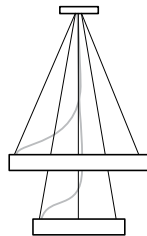

4844-3-36-36-36
REG / HO
4844-3-72-72-72
REG / HO

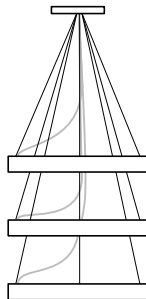

4844-3-54-36-24
REG / HO
4844-3-72-54-36
REG / HO

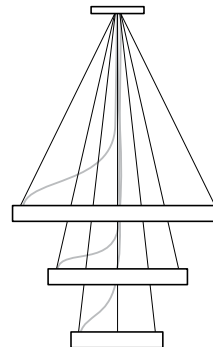

4844-3-36-54-36
REG / HO
4844-3-54-72-54
REG / HO

