

# COMPASS 4802

PROJECT PROJÉT
SPEC TYPE
NOTES

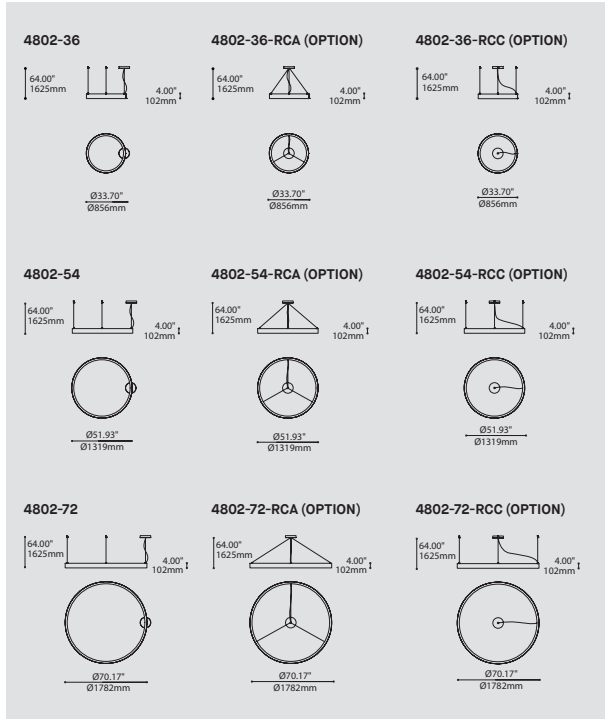

## MOUNTING OPTIONS OPTIONS DE MONTAGE

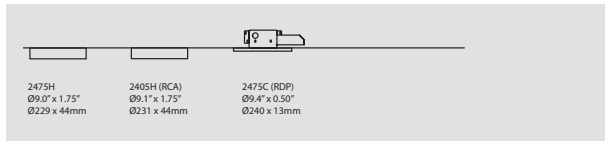

## ORDERING SPECIFICATION SPÉCIFICATION DE COMMANDE

MODEL MODÈLE CODE

4802-36	COMPASS 36"	
4802-54	COMPASS 54"	
4802-72	COMPASS 72"	

## LIGHT SOURCE SOURCE LUMINEUSE

(WATTAGE, LAMP TYPE, OTHER INFO)

4802-36	LED	REGULAR OUTPUT
4802-54	LED	REGULAR OUTPUT
4802-72	LED	REGULAR OUTPUT

## COLOR TEMPERATURE TEMPÉRATURE DE COULEUR

30	3000K
35	3500K
40	4000K

## VOLTAGE VOLTAGE

120V	120 VOLT
277V	277 VOLT

## DIMMING OPTION OPTION DE GRADATION

DV	0-10V DIMMING (120-277V)
DP	PHASE DIMMING (120V ONLY)

LED DIMMING DRIVER IS STANDARD IN THIS PRODUCT. PLEASE SPECIFY YOUR DIMMING TYPE.

## DRIVER POSITION POSITION DU PILOT

RDP	RECESSED DRIVER*
-----	------------------

\*3981C (80W) OR 3981D (128W & 174W) ACCESSORY IS REQUIRED

## CABLE CABLE

AC	AIRCRAFT MOUNTING & CLEAR CABLE, FIELD ADJUSTABLE	AC
----	---	----

## CABLE LENGTH LONGUEUR DE CABLE

60	60" AIRCRAFT CABLE (STD LENGTH)
**	CUSTOM AIRCRAFT CABLE LENGTH (PLEASE SPECIFY)

FOR OVERALL LENGTH PLEASE CONTACT YOUR EUREKA REPRESENTATIVE.

## MOUNTING OPTION OPTION DE MONTAGE

RC	ROUND CANOPY / PAVILLON ROND	RC
----	------------------------------	----

FOR RCA: 1.75" CANOPY (2405H)  
FOR RECESSED DRIVER OPTION: 0.50" CANOPY (2475C)  
FOR STANDARD: 1.75" CANOPY (2475H)

## MOUNTING CABLE OPTION OPTION DE MONTAGE DE CABLE

IF NO OPTION IS SELECTED, AN OFF-CENTERED ROUND CANOPY WITH STRAIGHT AIRCRAFT CABLES WILL BE PROVIDED

RCA	CENTERED ROUND CANOPY - AIRCRAFT CABLES ANGLED TO CENTER*
RCC	CENTERED ROUND CANOPY - STRAIGHT AIRCRAFT CABLES

\*NOT AVAILABLE WITH RECESSED DRIVER (RDP)

## CANOPY FINISH FINI PAVILLON

WHE	WHITE FINE TEXTURE	WHE
-----	--------------------	-----

## RING FINISH FINI ANNEAUX

WHE	WHITE FINE TEXTURE	WHE
-----	--------------------	-----

## DIFFUSER FINISH FINI DIFFUSEUR

WH	WHITE	WH
----	-------	----

## ACCESSORY ACCESSOIRE

3981C	JUNCTION BOX FOR RECESSED DRIVER OPTION (36"/54" DV AND 36" DP)
3981D	JUNCTION BOX FOR RECESSED DRIVER OPTION (72" DV AND 54"/72" DP)

## PRODUCT CHARACTERISTICS CARACTÉRISTIQUES DU PRODUIT

- BIM** **DIM** **IES** **LED**
- DESIGN:** Marrying simplicity and fineness, the Compass enhances the space with its elegantly shaped luminous halos.
- INSTALLATION:** Easy to install, adjust and level using triple aircraft cables; available with straight or angled cables towards a central canopy.
- LIGHT SOURCE:** Double row of custom designed light engine featuring high performance LED.
- STRUCTURE:** Seamlessly finished, rolled aluminum extrusion with highly reflective matte white polyester powder coating enclosed with an extruded optical PMMA diffuser snapped in place and finished with an elegant chrome plated joiner.
- CERTIFIED:** c-CSA-us

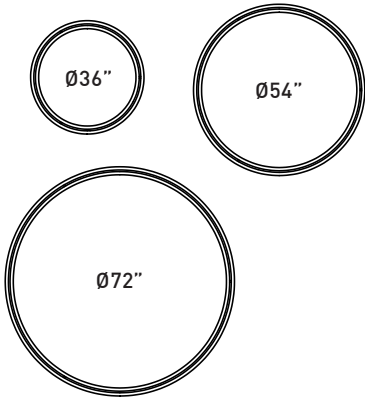
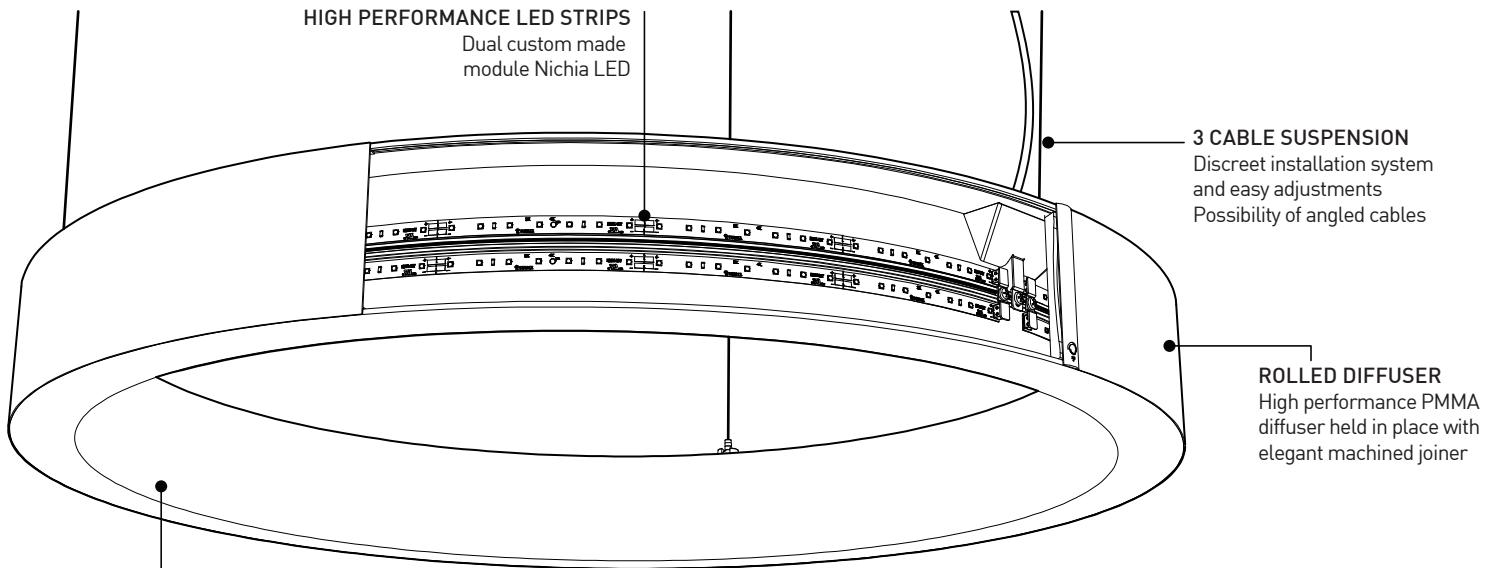

**3 VERSATILE SIZES**  
An infinite number of possible layout  
From smallest to the largest space

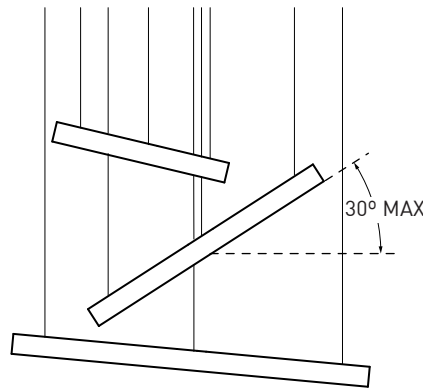

**HANG IT STRAIGHT OR ANGLED**  
Can be installed with a maximum horizontal angle of 30°

**CANOPY OPTIONS**

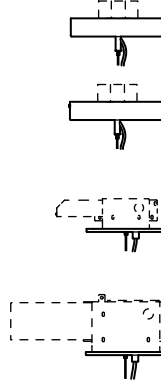

**SCREWLESS CANOPY 9.0"X1.75"**  
Mounting on a 4" standard j-box

**STANDARD CANOPY 9.0"X1.75"**  
Mounting on a 4" standard j-box  
For RCA option

**LOW PROFILE CANOPY 9.4"X0.50"**  
Mounting on Eureka box 3981C (**sold separately**)  
For 4802-36 / 4802-54 DV and 4802-36 DP  
Recessed driver for discreet installation

**LOW PROFILE CANOPY 9.4"X0.50"**  
Mounting on Eureka box 3981D (**sold separately**)  
For 4802-72 DV and 4802-54 / 4802-72 DP  
Recessed driver for discreet installation

**CANOPY POSITION**

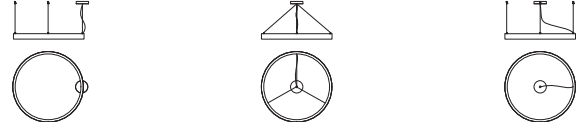

**4802-XX**  
Centered with mounting point (standart)

**4802-XX-RCA**  
Centered with luminaire / Centered cables

**4802-XX-RCC**  
Centered with luminaire / Straight cables

**SPECIFICATIONS**

	<b>4802-36</b>	<b>4802-54</b>	<b>4802-72</b>
LIGHT SOURCE	390x 0.37W Nichia ± 46W	624x 0.37W Nichia ± 69W	858x 0.37W Nichia ± 100W
DELIVERED LUMENS	5926lm (4000K)	8825lm (4000K)	12393lm (4000K)
SYSTEM WATTAGE	~54W	~78W	~115W
MODULE	UL Recognized - Custom design flexible strip - Made in USA		
CRI	85 CRI (typical)		
STRUCTURE	Custom CNC rolled aluminum extrusions (0.125in thickness) / Seamless welding		
VOLTAGE	120V or 277V	120V or 277V	120V or 277V
DRIVER	Standard phase (DP) or 0-10V (DV) dimming		
LM-79	On request		
WARRANTY	5 years		
WEIGHT (PACKAGED)	30 lbs	45 lbs	70 lbs



225 de Liège Ouest, Suite #200  
Montréal (QC), Canada H2P 1H4  
Tel : 514.385.3515 Fax : 514.385.4169  
www.eurekalighting.com



**4802-36 | 4802-54 | 4802-72**

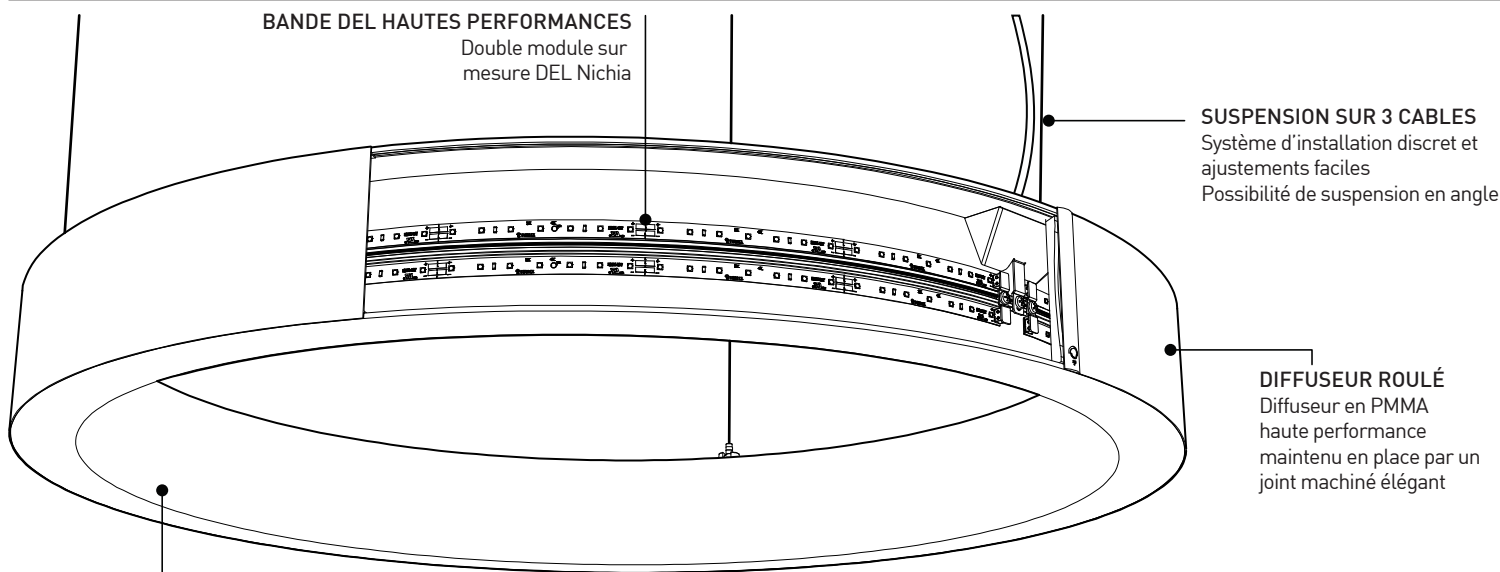

### OPTIONS DE PAVILLONS

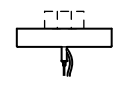

**PAVILLON SANS VIS 9.0"X1.75"**  
Installation sur boîte de connexion 4" standard

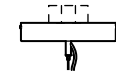

**PAVILLON STANDARD 9.0"X1.75"**  
Installation sur boîte de connexion 4" standard  
Pour option RCA

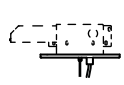

**PAVILLON PROFIL BAS 9.4"X0.50"**  
Installation sur boîte 3981C (vendue séparément)  
Pour 4802-36 / 4802-54 DV et 4802-36 DP  
Pilot encastré pour une installation discrète

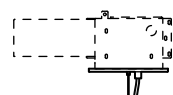

**PAVILLON PROFIL BAS 9.4"X0.50"**  
Installation sur boîte 3981D (vendue séparément)  
Pour 4802-72 DV et 4802-54 / 4802-72 DP  
Pilot encastré pour une installation discrète

### POSITION DU PAVILLON

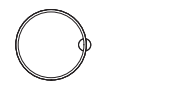

**4802-XX**  
Centré avec le point de montage (standard)



**4802-XX-RCA**  
Centré avec le luminaire / Câbles centrés



**4802-XX-RCC**  
Centré avec le luminaire / Câbles droits

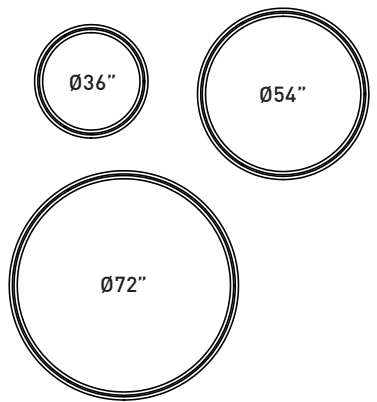

**3 FORMATS POLYVALENTS**  
Une infinité de combinaisons possibles  
Pour les petits aux plus grands espaces

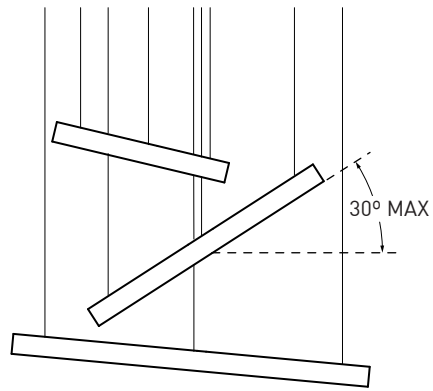

**SUSPENSION DROITE OU EN ANGLE**  
Peut être suspendu avec un angle horizontal maximal de 30°

### SPÉCIFICATIONS

	4802-36	4802-54	4802-72
SOURCE LUMINEUSE	390x 0.37W Nichia ± 46W	624x 0.37W Nichia ± 69W	858x 0.37W Nichia ± 100W
LUMENS REELS	5926lm (4000K)	8825lm (4000K)	12393lm (4000K)
PUISSANCE TOTALE	~54W	~78W	~115W
MODULE	Reconnu UL - Bandes DEL sur mesure - Fabriqué aux États-Unis		
IRC	85 IRC (typique)		
STRUCTURE	Extrusions d'aluminium roulées par CNC (0.125po d'épaisseur) / joints de soudure invisibles		
VOLTAGE	120V ou 277V	120V ou 277V	120V ou 277V
PILOTE	Gradation standard phase (DP) ou 0-10V (DV)		
LM-79	Sur demande		
GARANTIE	5 ans		
POIDS (EMBALLÉ)	30 lbs	45 lbs	70 lbs



225 de Liège Ouest, Suite #200  
Montréal (QC), Canada H2P 1H4  
Tel : 514.385.3515 Fax : 514.385.4169  
www.eurekalighting.com



4802-36 | 4802-54 | 4802-72