

FACET 4529-UFC

PROJECT PROJET
SPEC TYPE
NOTES

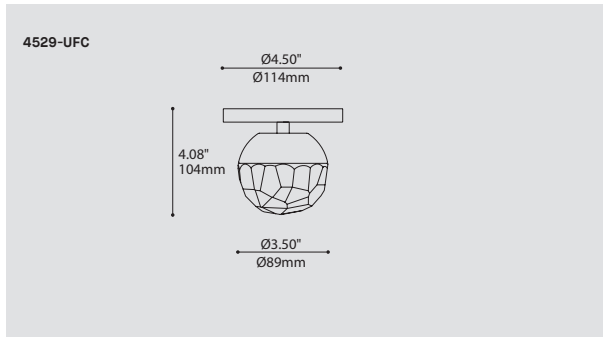

FAMILY FAMILLE

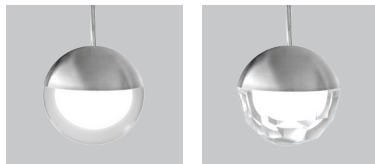

4029-UAC

4029-UFC



4428-UAC/UFC

4427-UAC/UFC

ORDERING SPECIFICATION	SPÉCIFICATION DE COMMANDE	CODE
MODEL MODÈLE	4529-UFC FACET	4529-UFC
LIGHT SOURCE SOURCE LUMINEUSE	(WATTAGE, LAMP TYPE, OTHER INFO) LED.1 1W, LED LED.4 4W, LED	
COLOR TEMPERATURE TEMPÉRATURE DE COULEUR	30 3000K 35 3500K 40 4000K	
VOLTAGE VOLTAGE	120V 120 VOLT 277V 277 VOLT	
DIMMING OPTION OPTION DE GRADATION	FOR LED 4W ONLY DV* 0-10V DIMMING (120-277V) DP* PHASE DIMMING (120V ONLY) *3983 ACCESSORY IS PROVIDED FOR DIMMING OPTION	
MOUNTING MONTAGE	RC ROUND CANOPY / PAVILLON ROND 0.5" CANOPY (2401C)	RC
STRUCTURE FINISH FINI STRUCTURE	SC SATIN CHROME	SC
HEATSINK FINISH FINI RADIATEUR	SAA SATIN ALUMINUM ANODIZED	SAA
DIFFUSER FINISH FINI DIFFUSEUR	CLR CLEAR FRO FROSTED	
ACCESSORY ACCESSOIRE	3983 DEEP JUNCTION BOX (PROVIDED FOR DIMMING LED 4W AS PER ABOVE)	

PRODUCT CHARACTERISTICS CARACTÉRISTIQUES DU PRODUIT

DIM **IES** **LED**

- DESIGN:** Meha and her edgy sister, Facet, are decorative spheres of light that can be used as single elegant geometrical objects to punctuate a space or in multiples to create illuminated clouds and populate larger areas.
- INSTALLATIONS:** Ceiling mounted on round canopy.
- LIGHT SOURCE:** Custom designed 1W and 4W LED modules available in both 3000K, 3500K or 4000K.
- STRUCTURE:** Satin aluminum anodized heat sink and heavy pressed glass diffuser with smooth (UAC) or faceted (UFC) surface.
- CERTIFIED:** c-CSA-us
- CONCEPTION:** Meha et sa sœur Facet aux multiples facettes sont des sphères de lumières décoratives pouvant être utilisées seules comme d'élégants objets géométriques rythmant un espace ou regroupées pour créer des nuées illuminées et combler de plus grands espaces.
- INSTALLATIONS:** Plafonnier sur pavillon rond.
- SOURCE LUMINEUSE:** Module DEL usiné sur mesure disponible en 1W et 4W en 3000K, 3500K ou 4000K.
- STRUCTURE:** Radiateur en aluminium anodisé satin clair et verre pressé épais avec une surface lisse (UAC) ou facettée (UFC).
- CERTIFIÉ:** c-CSA-us

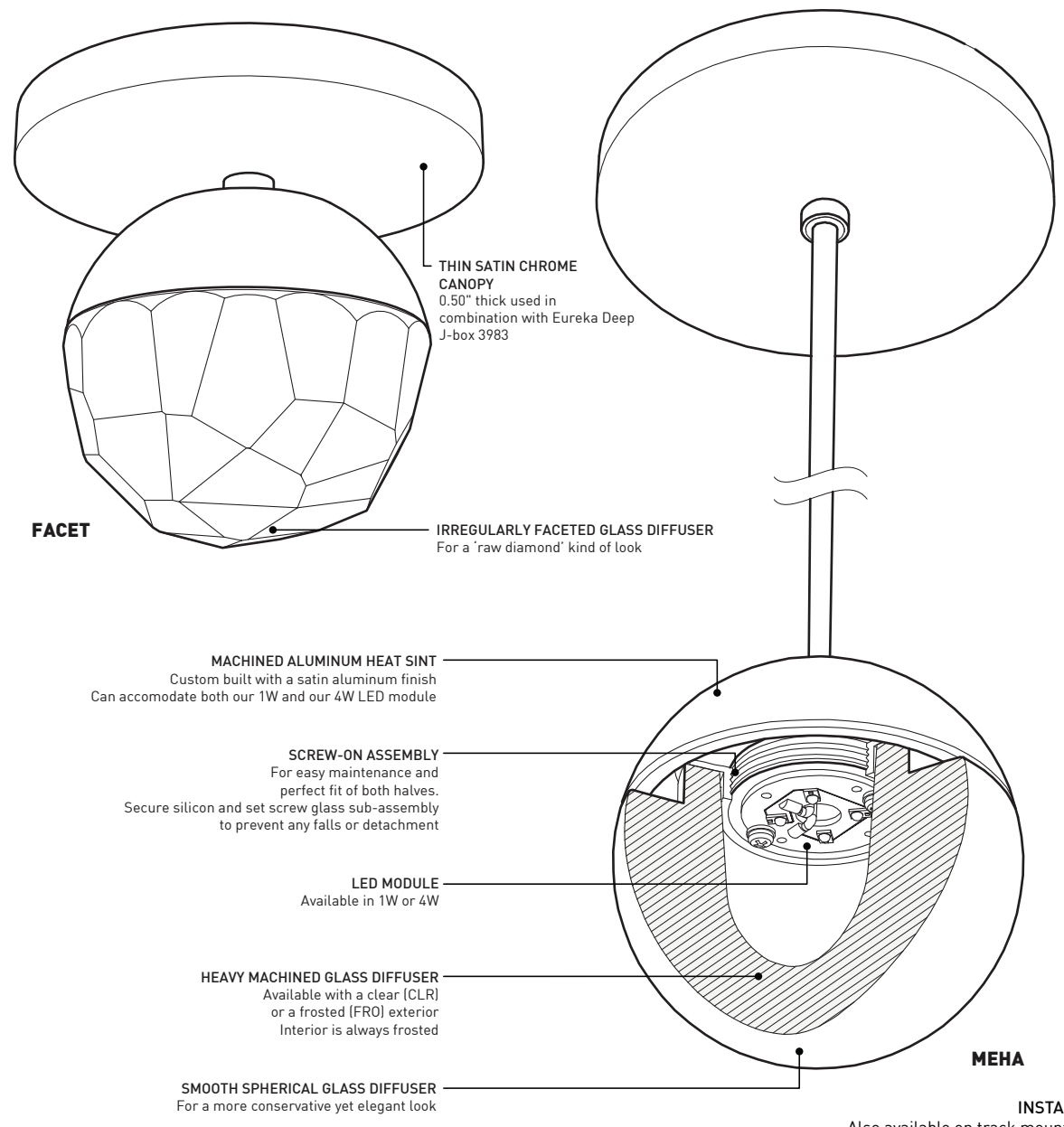
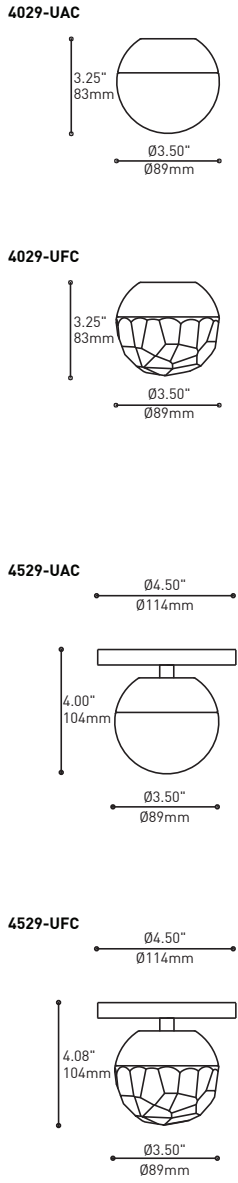

SPECIFICATIONS

	1W LED	4W LED
LIGHT SOURCE	1 x high powered LEDs on MCPCB - total ±1 w	4 x high powered LEDs on MCPCB - total ±4 w
MODULE	UL recognized - made in USA	
DELIVERED LUMENS	105 lm (4000K)	400 lm (4000K)
CRI	80 CRI (typical)	
LIGHT DISTRIBUTION	Direct	
HEATSINK	Machined aluminum with satin aluminum finish	
DIFFUSER	Heavy machined glass available in clear-frost(CLR) and frost(FRO) and smooth(UAC) or faceted(UFC)	
VOLTAGE	120V (DP) or 120-277V (DV or non-dimming)	
DRIVER	Constant Current driver 350 mA, UL Recognized	
DIMMING	Phase Dimming (DP) and 0-10V Dimming (DV)	
LM-79	On request	
WARRANTY	5 years (on electronic components)	
CERTIFICATION	CSA recognized	



EUREKA

225 de Liège Ouest, Suite #200
Montréal (QC), Canada H2P 1H4
Tel : 514.385.3515 Fax : 514.385.4169
www.eurekalighting.com



4029-UAC
4029-UFC

4529-UAC
4529-UFC

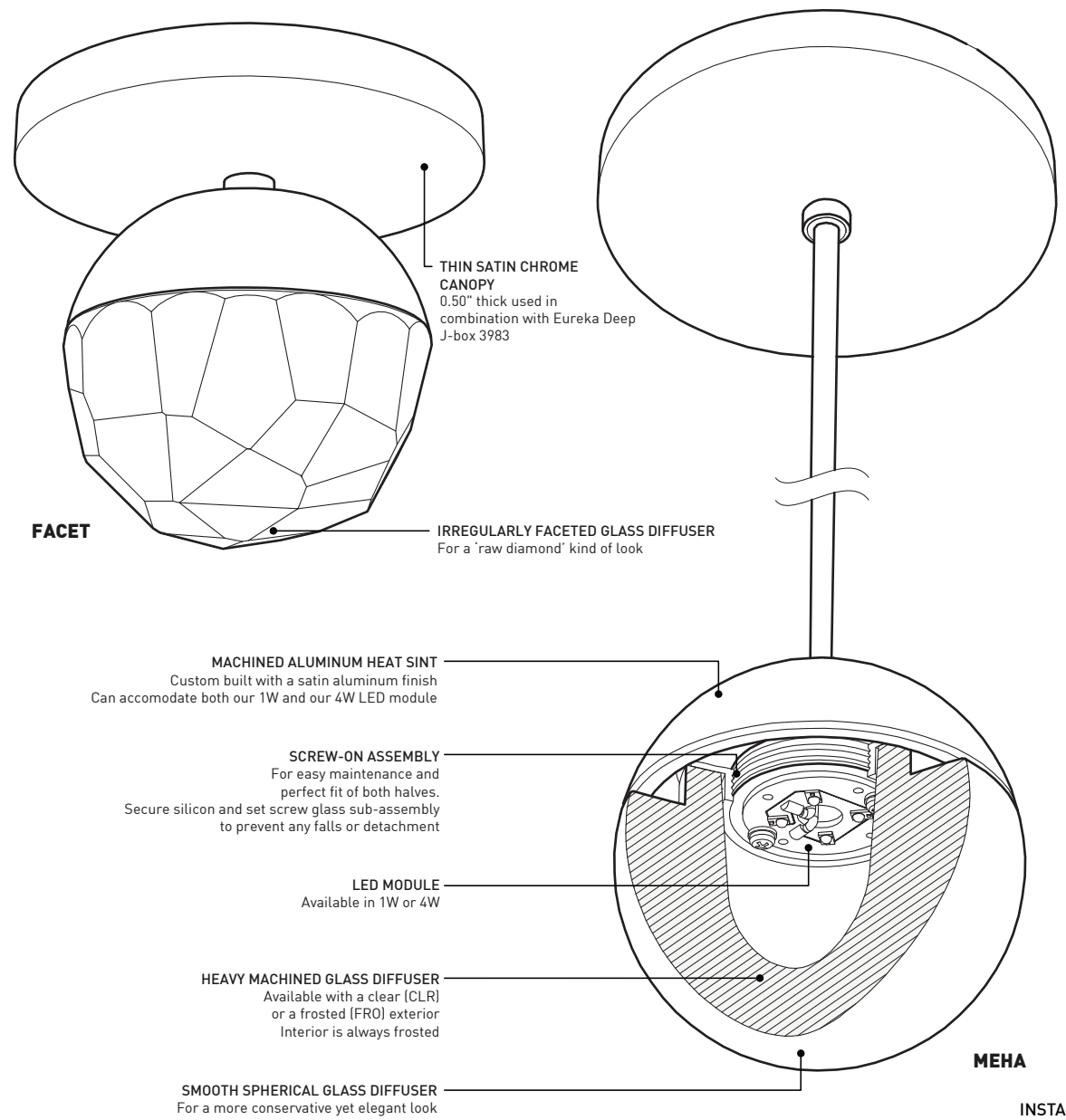
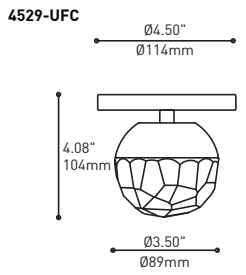
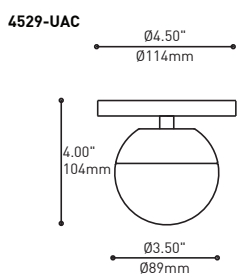
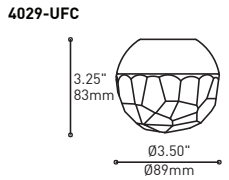
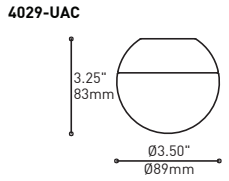

SPECIFICATIONS

	1W LED	4W LED
LIGHT SOURCE	1 x high powered LEDs on MCPCB - total ±1 w	4 x high powered LEDs on MCPCB - total ±4 w
MODULE	UL recognized - made in USA	
DELIVERED LUMENS	105 lm (4000K)	400 lm (4000K)
CRI	80 CRI (typical)	
LIGHT DISTRIBUTION	Direct	
HEATSINK	Machined aluminum with satin aluminum finish	
DIFFUSER	Heavy machined glass available in clear-frost(CLR) and frost(FRO) and smooth(UAC) or faceted(UFC)	
VOLTAGE	120V (DP) or 120-277V (DV or non-dimming)	
DRIVER	Constant Current driver 350 mA, UL Recognized	
DIMMING	Phase Dimming (DP) and 0-10V Dimming (DV)	
LM-79	On request	
WARRANTY	5 years (on electronic components)	
CERTIFICATION	CSA recognized	



225 de Liège Ouest, Suite #200
Montréal (QC), Canada H2P 1H4
Tel : 514.385.3515 Fax : 514.385.4169
www.eurekalighting.com



4029-UAC
4029-UFC

4529-UAC
4529-UFC

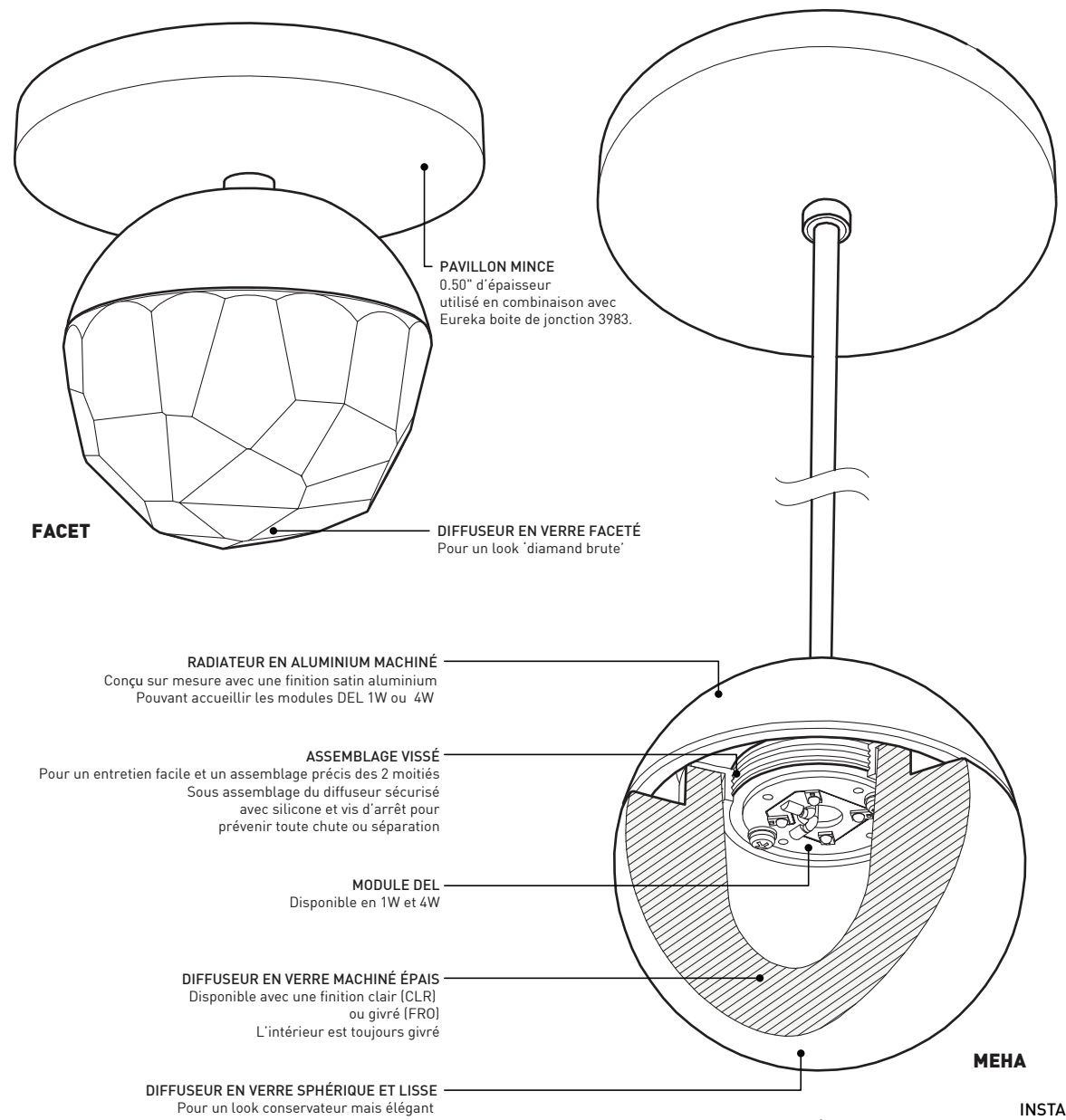
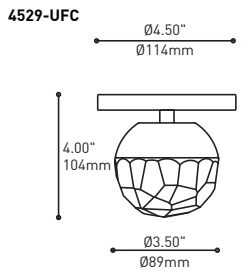
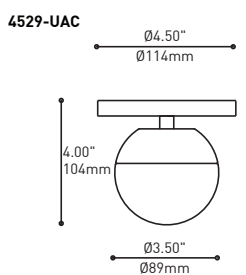
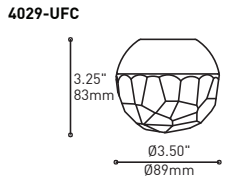
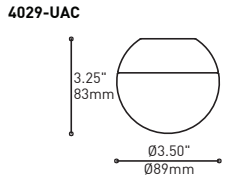

SPÉCIFICATIONS

SOURCE LUMINEUSE
MODULE
LUMENS RÉELS
IRC
DISTRIBUTION LUMINEUSE
RADIATEUR
DIFFUSEUR
VOLTAGE
DRIVER
GRADATION
LM-79
WARRANTY
CERTIFICATION

DEL 1W

1 DEL 1W haute puissance sur MCPCB - total ±1 w
Reconnue par UL - Fabriqué aux États-Unis
105 lm (4000K)
80 CRI (typique)
Direct
Aluminium machiné avec finition satin aluminium
Verre machiné épais disponible en clair (CLR) et en givré (FRO) ainsi qu'en lisse (UAC) ou faceté (UFC)
120V (DP) ou 120-277V (DV ou sans intensité variable)
Pilote constant courant 350 mA, reconnu UL
Gradation de type 'Phase Dimming' (DP) et de type '0-10V Dimming' (DV)
Sur demande
5 ans (sur les composantes électroniques)
Reconnu pas CSA

DEL 4W

4 DEL 1W haute puissance sur MCPCB - total ±4 w
400 lm (4000K)



225 de Liège Ouest, Suite #200
Montréal (QC), Canada H2P 1H4
Tel : 514.385.3515 Fax : 514.385.4169
www.eurekalighting.com



4029-UAC
4029-UFC

4529-UAC
4529-UFC