

SLIM SHADY 4411-GGS

PROJECT PROJÉT
SPEC TYPE
NOTES

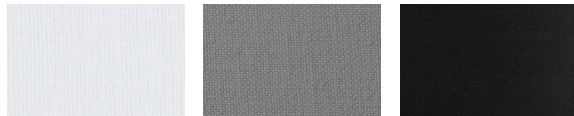

OPTIONS



WLT (WASHABLE) GLT (WASHABLE) BLT (WASHABLE)

OVERALL HEIGHT HAUTEUR HORS TOUT

LIGHT SOURCE	TRACK 1 CIRCUIT	INC CFL GU24
MOUNTING	2734B	2401E
CABLE	-	67.45"
STEM	43.65"	43.30"

MOUNTING OPTIONS OPTIONS DE MONTAGE

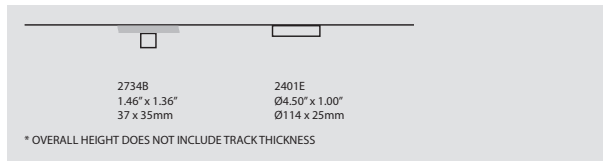

STEM OR CABLE OPTIONS OPTIONS DE TIGE OU CABLE

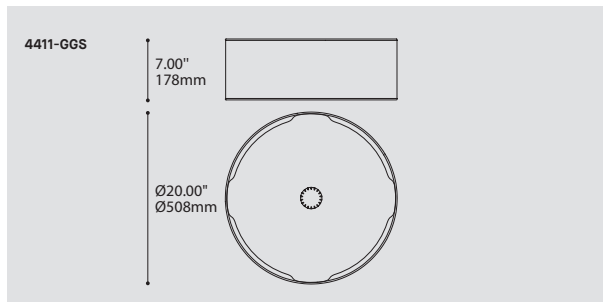
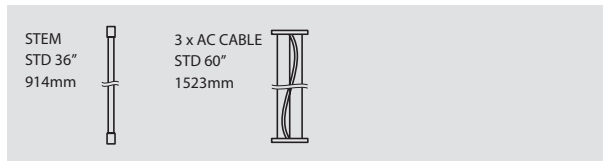

ORDERING SPECIFICATION	SPÉCIFICATION DE COMMANDE	CODE
MODEL MODÈLE		4411-GGS
4411-GGS	SLIM SHADY (WITH CENTER SPOTLIGHT)	
LIGHT SOURCE SOURCE LUMINEUSE		
<small>(WATTAGE, LAMP TYPE, LAMP FORM, BASE TYPE, OTHER INFO)</small>		
3XCF.SP.13+INC.35	13W X 3, CFL, SPIRAL, GU24 BASE + 35W, INC, PAR20, MEDIUM BASE	
3XINC.40+INC.35	40W X 3, INC, A19 / B10 / HAL T10 + 35W, INC PAR20, MEDIUM BASE	
VOLTAGE VOLTAGE		120V
120V	120 VOLT	
STEM OR CABLE TIGE OU CABLE		
S10	3/8" (10MM) STEM, NOT FIELD ADJUSTABLE	
AC**	AIRCRAFT MOUNTING & CLEAR CABLE, FIELD ADJUSTABLE	
	**NOT AVAILABLE WITH A TRACK ADAPTOR	
STEM OR CABLE LENGTH LONGUEUR DE TIGE OU CABLE		
36	36" STEM (STD LENGTH)	
60	60" AIRCRAFT CABLE (STD LENGTH)	
**	CUSTOM STEM LENGTH (PLEASE SPECIFY)	
**	CUSTOM AIRCRAFT CABLE LENGTH (PLEASE SPECIFY)	
	FOR OVERALL LENGTH PLEASE CONTACT YOUR EUREKA REPRESENTATIVE.	
MOUNTING MONTAGE		
RC	ROUND CANOPY / PAVILLON ROND FOR INC & CFL: 1.00" CANOPY (2401E)	
TA1	TRACK ADAPTOR / ADAPTATEUR DE RAIL 1 CIRCUIT 120V ADAPTOR (2734B)	
MOUNTING OPTION OPTION DE MONTAGE		
SCA*	SLOPE CEILING ADAPTOR / ADAPTATEUR DE PLAFOND EN PENTE (ROTATION: 350°, PIVOT: 90°) *ONLY AVAILABLE WITH A STEM	
TRACK ADAPTOR FINISH FINI ADAPTATEUR DE RAIL^(A)		
WH	WHITE	
BLK	BLACK	
	^(A) FILL IN IF A TRACK ADAPTOR IS SELECTED, OTHERWISE LEAVE EMPTY	
STRUCTURE FINISH FINI STRUCTURE		
CHR	CHROME	
SC	SATIN CHROME	
CANOPY FINISH FINI PAVILLON^(B)		
WHE	WHITE FINE TEXTURE ^(B) INCLUDE CANOPY FINISH IF A CANOPY IS SELECTED	
SHADE FINISH FINI ABAT-JOUR		
WLT	WHITE - LINEN TRILAM	
BLT	BLACK - LINEN TRILAM	
GLT	GRAY - LINEN TRILAM	
ACRYLIC FINISH FINI ACRYLIQUE		
WH	WHITE	
BLK	BLACK	

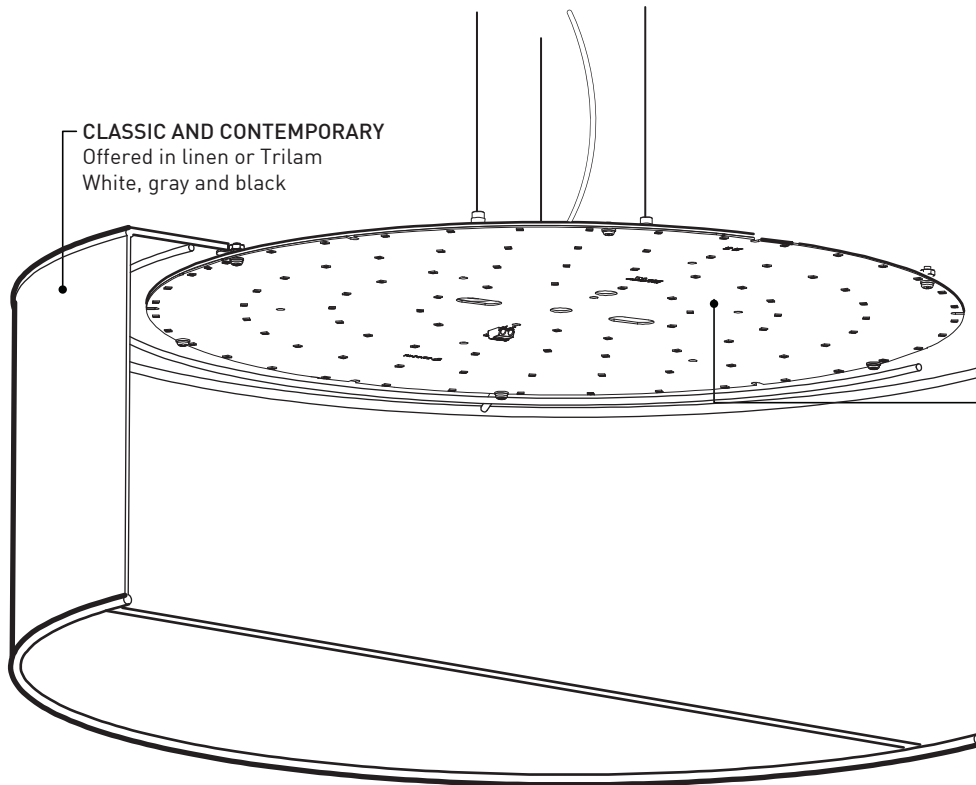

CLASSIC AND CONTEMPORARY
Offered in linen or Trilam
White, gray and black

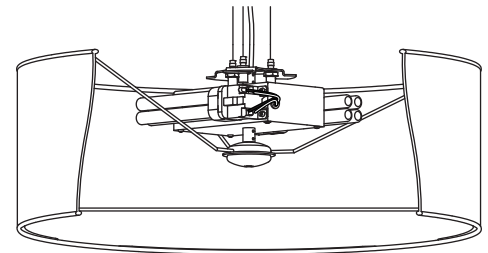

FLUORESCENT CROSS-SECTION

LARGE ROUND LED BOARD
96 Nichia LED chips
consuming 24W of power

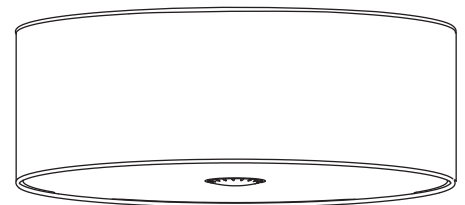

4411-GGS OPTION
Also offered with PAR20 down light in the center of the diffuser for improved direct lighting (only available in INC and CF.SP.13)



7.0"
178mm

TRILAM: WASHABLE & STAIN RESISTANT, IDEAL FOR COMMERCIAL USE

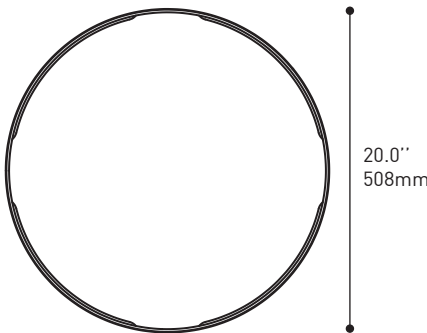

20.0"
508mm

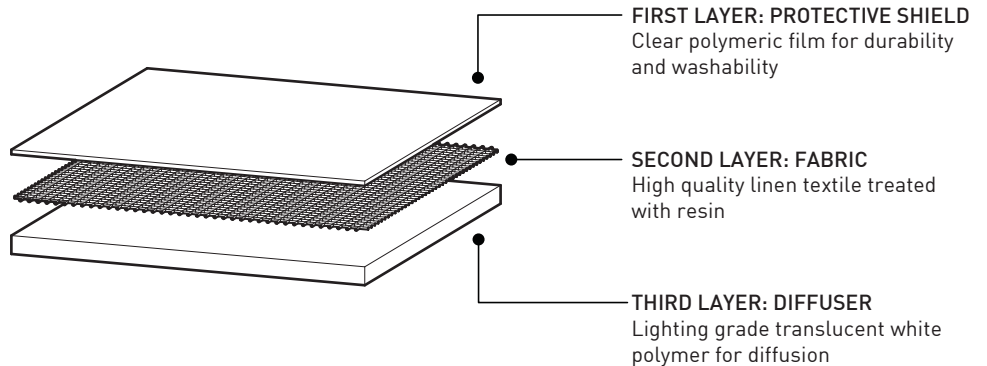

SPECIFICATIONS

4411-GGC

	LED.24.XX	2XCF.D.18	3XCF.SP.13	3XINC.40	4411-GGS	3XCF.SP.13	3XINC.40
LIGHT SOURCE							
VOLTAGE		120V-277V or 347V	120V	120V	120V		120V
DIMMING	DV 0-10V (120-277V) or DP PHASE DIMMING (120V)	DM1, DM7, DED, DE3					
CERTIFICATION	c-CSA-us						
WARRANTY	5 year warranty on LED fixtures, 1 year warranty on fluorescent fixtures						



225 de Liège Ouest, Suite #200
Montréal (QC), Canada H2P 1H4
Tel : 514.385.3515 Fax : 514.385.4169
www.eurekalighting.com



4411-GGX

CLASSIQUE ET CONTEMPORAIN
Offert en lin ou Trilam
Blanc, gris et noir

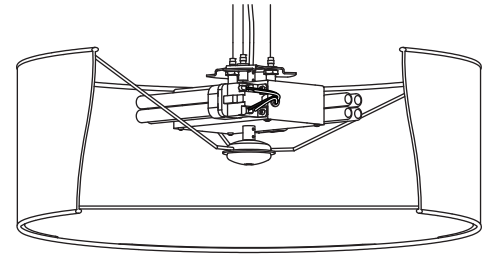
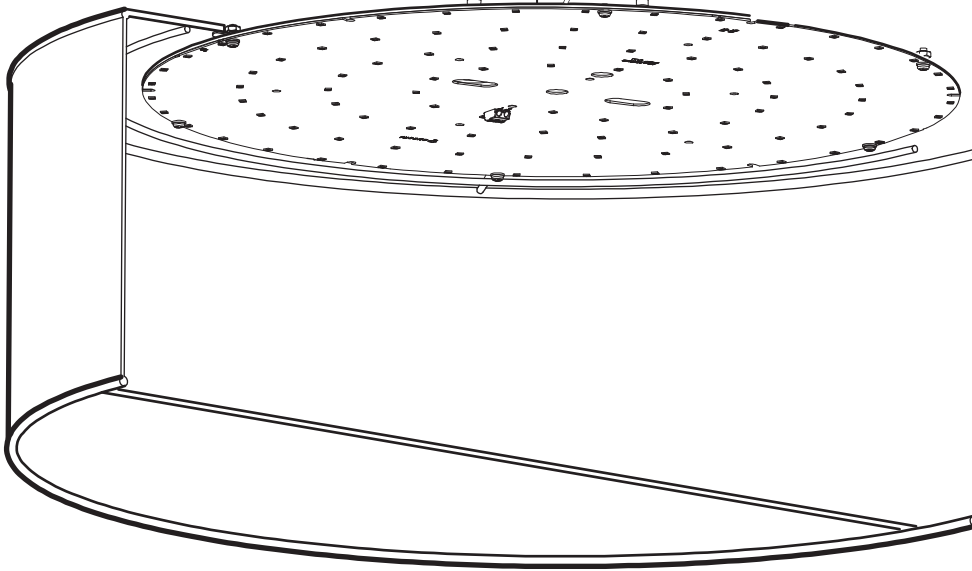

VUE COUPÉE
OPTION FLUORESCENT

PANNEAU DEL ROND ET LARGE
96 diodes Nichia
consommant 24W

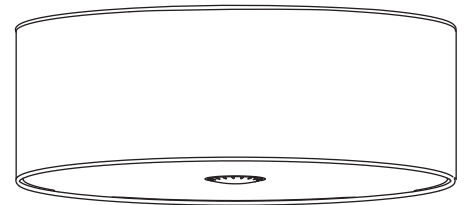

OPTION 4411-GGS

Aussi disponible avec éclairage vers le bas
ampoule PAR20 centrée sur le diffuseur pour
un éclairage direct (Disponible seulement en
INC et CF.SP.13)



7.0"
178mm

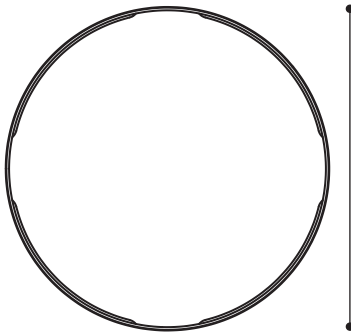

20.0"
508mm

TRILAM: MATÉRIAU LAVABLE & RESISTANT AUX TACHES, IDEAL POUR LES APPLICATIONS COMMERCIALES

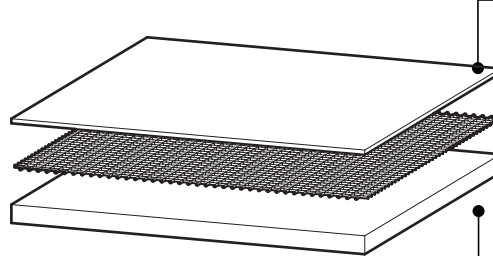

COUCHE 1: BOUCLIER PROTECTEUR
Film transparent polymérique pour
une durabilité et nettoyabilité accrues

COUCHE 2: TISSUS
Lin tissé de haute qualité traité avec
une résine plastique

COUCHE 3: DIFFUSEUR
Feuille de polymère grade éclairage
à haute diffusion

SPECIFICATIONS

	4411-GGC				4411-GGS	
SOURCE LUMINEUSE	LED.24.XX	2XCF.D.18	3XCF.SP.13	3XINC.40	3XCF.SP.13	3XINC.40
VOLTAGE		120V-277V ou 347V	120V	120V	120V	120V
GRADATION	DV 0-10V (120-277V) ou DP PHASE DIMMING (120V)	DM1, DM7, DED, DE3				
CERTIFICATION	c-CSA-us					
GARANTIE	Garantie de 5 ans sur le luminaire en DEL, Garantie de 1 an sur les luminaires en fluoescnt					