

# SLIM SHADY 4411-GGC

PROJECT PROJÉT
SPEC TYPE
NOTES

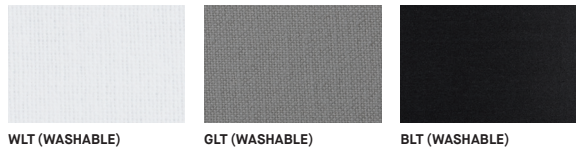

## OPTIONS



## OVERALL HEIGHT HAUTEUR HORS TOUT

LIGHT SOURCE	TRACK 1 CIRCUIT	INC CFL GU24	LED
MOUNTING	2734B	2401E	2403G
CABLE	-	67.45"	67.95"
STEM	43.65"	43.30"	-

## MOUNTING OPTIONS OPTIONS DE MONTAGE

2734B	2401E	2403G
1.46" x 1.36" 37 x 35mm	04.50" x 1.00" Ø114 x 25mm	04.50" x 1.50" Ø114 x 38mm

\* OVERALL HEIGHT DOES NOT INCLUDE TRACK THICKNESS

## STEM OR CABLE OPTIONS OPTIONS DE TIGE OU CABLE

STEM STD 36" 914mm	3 x AC CABLE STD 60" 1523mm
--------------------------	-----------------------------------

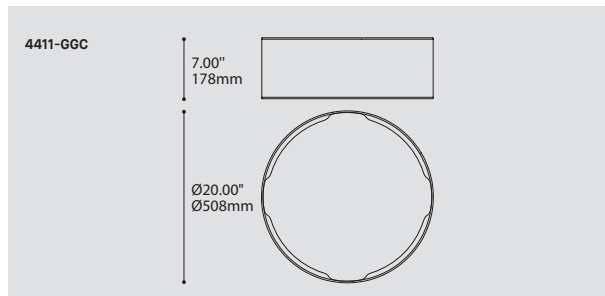

## ORDERING SPECIFICATION SPÉCIFICATION DE COMMANDE

MODEL MODÈLE	4411-GGC	SLIM SHADY	CODE	4411-GGC
<b>LIGHT SOURCE SOURCE LUMINEUSE</b>				
(WATTAGE, LAMP TYPE, LAMP FORM, BASE TYPE, OTHER INFO)				
<b>3XCF.SP.13</b>		13W X 3, CFL, SPIRAL, GU24 BASE (120V ONLY)		
<b>2XCF.D.18</b>		18W X 2, CFL, DOUBLE TWIN TUBE, G24Q2 BASE		
<b>3XINC.40</b>		40W X 3, INC, A19 / B10 / HAL T10, MEDIUM BASE (120V ONLY)		
<b>LED.24*</b>		24W, LED		
		*NOT AVAILABLE WITH A TRACK ADAPTOR		
<b>COLOR TEMPERATURE TEMPÉRATURE DE COULEUR</b>				
FOR LED ONLY				
<b>30</b>	3000K			
<b>35</b>	3500K			
<b>40</b>	4000K			
<b>VOLTAGE VOLTAGE</b>				
<b>120V</b>	120 VOLT			
<b>277V*</b>	277 VOLT			
<b>347V*</b>	347 VOLT			
	*NOT AVAILABLE WITH A TRACK ADAPTOR			
	**ONLY AVAILABLE WITH CF.D.18 (NON-DIMMING BALLAST)			
<b>DIMMING OPTION OPTION DE GRADATION</b>				
AVAILABLE WITH 2XCF.D.18				
<b>DM1</b>	ADVANCE MARK 10 ELECTRONIC DIMMING BALLAST			
<b>DM7*</b>	ADVANCE MARK 7 ELECTRONIC DIMMING BALLAST			
<b>DED*</b>	LUTRON ECOSYSTEM ELECTRONIC DIMMING BALLAST (ECOSYSTEM DIGITAL LINK WIRING)			
<b>DE3*</b>	LUTRON ECOSYSTEM ELECTRONIC DIMMING BALLAST (3-WIRE WIRING)			
AVAILABLE WITH LED ONLY				
<b>DV</b>	0-10V DIMMING (120-277V)			
<b>DP</b>	PHASE DIMMING (120V ONLY)			
	LED DIMMING DRIVER IS STANDARD IN THIS PRODUCT, PLEASE SPECIFY YOUR DIMMING TYPE.			
<b>STEM OR CABLE TIGE OU CABLE</b>				
<b>S10*</b>	3/8" (10MM) STEM, NOT FIELD ADJUSTABLE			
<b>AC**</b>	AIRCRAFT MOUNTING & CLEAR CABLE, FIELD ADJUSTABLE			
	*NOT AVAILABLE WITH LED LIGHT SOURCE			
	**NOT AVAILABLE WITH A TRACK ADAPTOR			
<b>STEM OR CABLE LENGTH LONGUEUR DE TIGE OU CABLE</b>				
<b>36</b>	36" STEM (STD LENGTH)			
<b>60</b>	60" AIRCRAFT CABLE (STD LENGTH)			
<b>**</b>	CUSTOM STEM LENGTH (PLEASE SPECIFY)			
<b>**</b>	CUSTOM AIRCRAFT CABLE LENGTH (PLEASE SPECIFY)			
	FOR OVERALL LENGTH PLEASE CONTACT YOUR EUREKA REPRESENTATIVE.			
<b>MOUNTING MONTAGE</b>				
<b>RC</b>		ROUND CANOPY / PAVILLON ROND		
		FOR INC & CFL: 1.00" CANOPY (2401E)		
		FOR DIMMING LED: 1.75" CANOPY (2403G)		
<b>TA1</b>		TRACK ADAPTOR / ADAPTATEUR DE RAIL		
		1 CIRCUIT		
		120V ADAPTOR (2734B)		
<b>MOUNTING OPTION OPTION DE MONTAGE</b>				
<b>SCA*</b>	SLOPE CEILING ADAPTOR / ADAPTATEUR DE PLAFOND EN PENTE			
	(ROTATION: 350°, PIVOT: 90°)			
	*ONLY AVAILABLE WITH A STEM			
<b>TRACK ADAPTOR FINISH FINI ADAPTATEUR DE RAIL (A)</b>				
<b>WH</b>	WHITE			
<b>BLK</b>	BLACK			
	(A) FILL IN IF A TRACK ADAPTOR IS SELECTED, OTHERWISE LEAVE EMPTY			
<b>STRUCTURE FINISH FINI STRUCTURE</b>				
<b>CHR</b>	CHROME			
<b>S C</b>	SATIN CHROME			
<b>CANOPY FINISH FINI PAVILLON (B)</b>				
<b>WHE</b>	WHITE FINE TEXTURE			
	(B) INCLUDE CANOPY FINISH IF A CANOPY IS SELECTED			
<b>SHADE FINISH FINI ABAT-JOUR</b>				
<b>WLT</b>	WHITE - LINEN TRILAM			
<b>BLT</b>	BLACK - LINEN TRILAM			
<b>GLT</b>	GRAY - LINEN TRILAM			
<b>ACRYLIC FINISH FINI ACRYLIQUE (C)</b>				
<b>WH</b>	WHITE			
<b>BLK</b>	BLACK			
	(C) IF LED LIGHT SOURCE IS SELECTED, ACRYLIC OFFERED IN WHITE ONLY.			

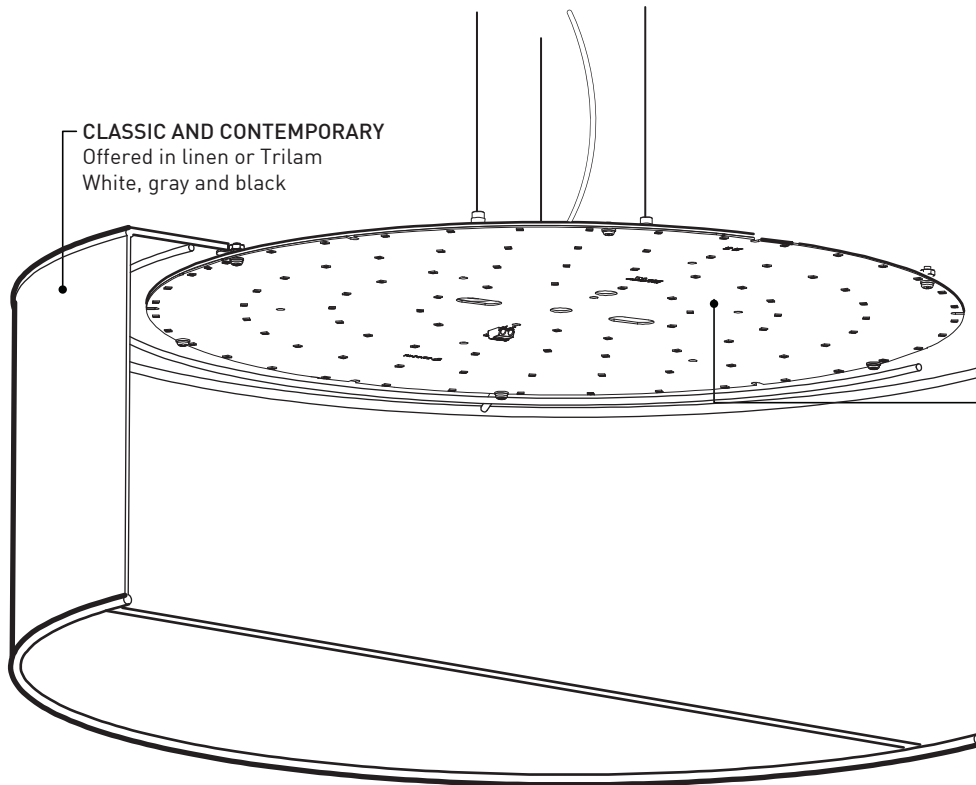

**CLASSIC AND CONTEMPORARY**  
Offered in linen or Trilam  
White, gray and black

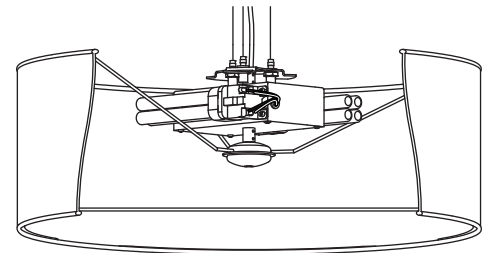

**FLUORESCENT CROSS-SECTION**

**LARGE ROUND LED BOARD**  
96 Nichia LED chips  
consuming 24W of power

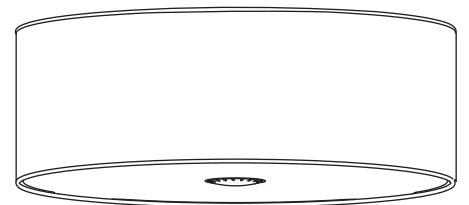

**4411-GGS OPTION**  
Also offered with PAR20 down light in the center of the diffuser for improved direct lighting (only available in INC and CF.SP.13)

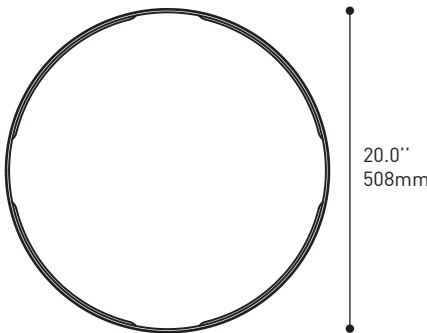

**TRILAM: WASHABLE & STAIN RESISTANT, IDEAL FOR COMMERCIAL USE**

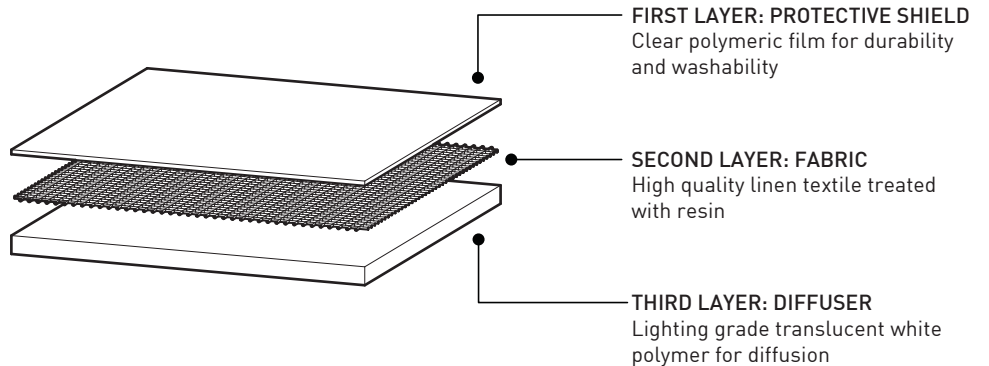

**FIRST LAYER: PROTECTIVE SHIELD**  
Clear polymeric film for durability and washability

**SECOND LAYER: FABRIC**  
High quality linen textile treated with resin

**THIRD LAYER: DIFFUSER**  
Lighting grade translucent white polymer for diffusion

## SPECIFICATIONS

SPECIFICATIONS	4411-GGC				4411-GGS	
	LED.24.XX	2XCF.D.18	3XCF.SP.13	3XINC.40	3XCF.SP.13	3XINC.40
LIGHT SOURCE	LED.24.XX	2XCF.D.18	3XCF.SP.13	3XINC.40	3XCF.SP.13	3XINC.40
VOLTAGE		120V-277V or 347V	120V	120V	120V	120V
DIMMING	DV 0-10V (120-277V) or DP PHASE DIMMING (120V)	DM1, DM7, DED, DE3				
CERTIFICATION	c-CSA-us					
WARRANTY	5 year warranty on LED fixtures, 1 year warranty on fluorescent fixtures					



225 de Liège Ouest, Suite #200  
Montréal (QC), Canada H2P 1H4  
Tel : 514.385.3515 Fax : 514.385.4169  
www.eurekalighting.com



**4411-GGX**

**CLASSIQUE ET CONTEMPORAIN**  
Offert en lin ou Trilam  
Blanc, gris et noir

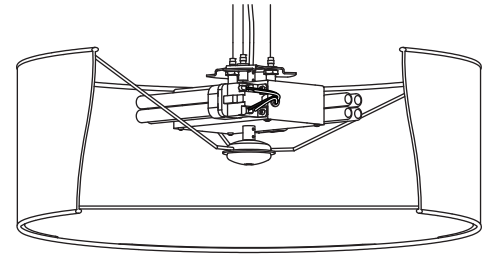
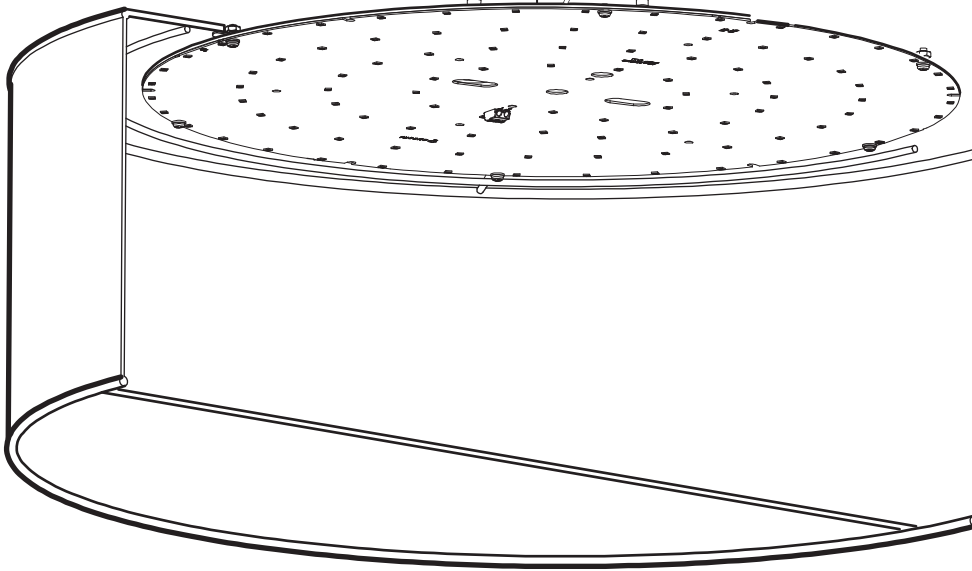

**VUE COUPÉE**  
OPTION FLUORESCENT

**PANNEAU DEL ROND ET LARGE**  
96 diodes Nichia  
consommant 24W

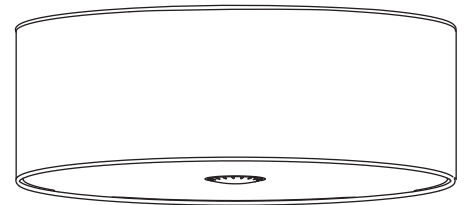

**OPTION 4411-GGS**

Aussi disponible avec éclairage vers le bas  
ampoule PAR20 centrée sur le diffuseur pour  
un éclairage direct (Disponible seulement en  
INC et CF.SP.13)

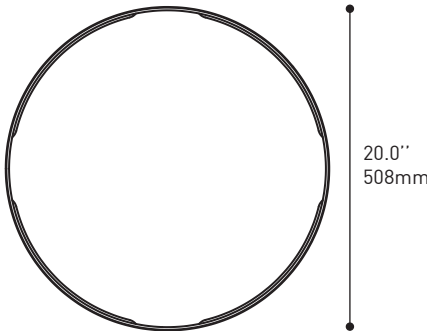

**TRILAM: MATÉRIAU LAVABLE & RESISTANT AUX TACHES, IDEAL POUR LES APPLICATIONS COMMERCIALES**

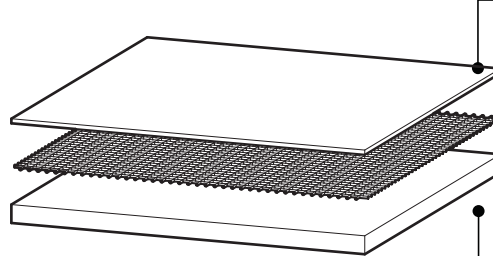

**COUCHE 1: BOUCLIER PROTECTEUR**  
Film transparent polymérique pour  
une durabilité et netoyabilité accrues

**COUCHE 2: TISSUS**  
Lin tissé de haute qualité traité avec  
une résine plastique

**COUCHE 3: DIFFUSEUR**  
Feuille de polymère grade éclairage  
à haute diffusion

**SPECIFICATIONS**

	4411-GGC				4411-GGS	
SOURCE LUMINEUSE	LED.24.XX	2XCF.D.18	3XCF.SP.13	3XINC.40	3XCF.SP.13	3XINC.40
VOLTAGE		120V-277V ou 347V	120V	120V	120V	120V
GRADATION	DV 0-10V (120-277V) ou DP PHASE DIMMING (120V)	DM1, DM7, DED, DE3				
CERTIFICATION	c-CSA-us					
GARANTIE	Garantie de 5 ans sur le luminaire en DEL, Garantie de 1 an sur les luminaires en fluoescnt					



225 de Liège Ouest, Suite #200  
Montréal (QC), Canada H2P 1H4  
Tel : 514.385.3515 Fax : 514.385.4169  
www.eurekalighting.com



**4411-GGX**