

FLYNN 4264-22

PROJECT PROJET
SPEC TYPE
NOTES



OPTIONS



WHE

OVERALL HEIGHT HAUTEUR HORS TOUT

LIGHT SOURCE	LED DIM
MOUNTING	2471C
STEM	44.35"
CABLE	68.35"

MOUNTING OPTIONS OPTIONS DE MONTAGE



STEM OR CABLE OPTIONS OPTIONS DE TIGE OU CÂBLE

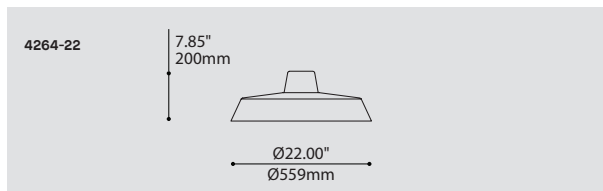
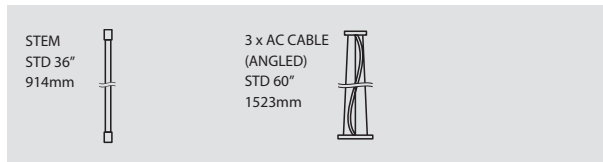

ORDERING SPECIFICATION	SPÉCIFICATION DE COMMANDE	CODE
MODEL MODÈLE	4264-22 FLYNN 22"	4264-22
LIGHT SOURCE SOURCE LUMINEUSE	(WATTAGE, LAMP TYPE, OTHER INFO) LED.20 20W, LED	LED.20
COLOR TEMPERATURE TEMPÉRATURE DE COULEUR	30 3000K 35 3500K 40 4000K	
VOLTAGE VOLTAGE	120V 120 VOLT 277V 277 VOLT	
DIMMING OPTION OPTION DE GRADATION	DV 0-10V DIMMING (120-277V) DP PHASE DIMMING (120V ONLY) LED DIMMING DRIVER IS STANDARD IN THESE PRODUCTS	
STEM OR CABLE TIGE OU CÂBLE	S10 3/8" (10MM) STEM, NOT FIELD ADJUSTABLE AC AIRCRAFT MOUNTING & CLEAR CABLE, FIELD ADJUSTABLE STEM FINISH SAME AS EXTERIOR SHADE FINISH	
STEM OR CABLE LENGTH LONGUEUR DE TIGE OU CÂBLE	36 36" STEM (STD LENGTH) 60 60" AIRCRAFT CABLE (STD LENGTH) ** CUSTOM STEM LENGTH (PLEASE SPECIFY) ** CUSTOM AIRCRAFT CABLE LENGTH (PLEASE SPECIFY) FOR OVERALL LENGTH PLEASE CONTACT YOUR EUREKA REPRESENTATIVE.	
MOUNTING MONTAGE	RC ROUND CANOPY / PAVILLON ROND FOR LED: 0.50" CANOPY (2471C)	RC
STRUCTURE FINISH FINI STRUCTURE	WHE WHITE FINE TEXTURE ANTE ANTHRACITE FINE TEXTURE	
EXTERIOR SHADE FINISH FINI ABAT-JOUR EXTÉRIEUR	WHE WHITE FINE TEXTURE ANTE ANTHRACITE FINE TEXTURE	
INTERIOR SHADE FINISH FINI ABAT-JOUR INTÉRIEUR	WH WHITE	WH

PRODUCT CHARACTERISTICS CARACTÉRISTIQUES DU PRODUIT



DESIGN:	Under this large size shade with straight, imposing lines, hides a reflector with soft curves and a generous personality. A concealed LED light source underneath the fixture projects a soft and seductive indirect light.
INSTALLATION:	Available on a stem or with an easy-to-install triple aircraft cable configuration.
LIGHT SOURCE:	Custom LED light engine with integrated driver with standard phase or 0-10V dimming capability.
STRUCTURE:	Custom design spun aluminum shade available in 22" or 35" diameter, with white or anthracite architectural grade fine texture finishes.
REFLECTOR:	Thermoformed acrylic with matte white frosted finish for optimal light diffusion.
CERTIFIED:	c-CSA-us
CONCEPTION:	Sous cet abat-jour grand format aux lignes droites et imposantes se cache un réflecteur aux courbes douces et au caractère généreux. Une source DEL dissimulée sous le luminaire projette une séduisante lumière indirecte.
INSTALLATION:	Offert en option tige ou triple câble d'acier simple d'installation.
SOURCE LUMINEUSE:	Module DEL sur mesure incluant une unité d'alimentation intégrée avec gradation standard de type phase ou 0-10V.
STRUCTURE:	Abat-jour en aluminium repoussé fait sur mesure, offert en diamètres de 22" ou 35", avec peinture blanche ou anthracite finement texturée de grade architectural.
RÉFLECTEUR:	Acrylique thermoformé de couleur blanc mat et givré améliorant la diffusion lumineuse.
CERTIFIÉ:	c-CSA-us

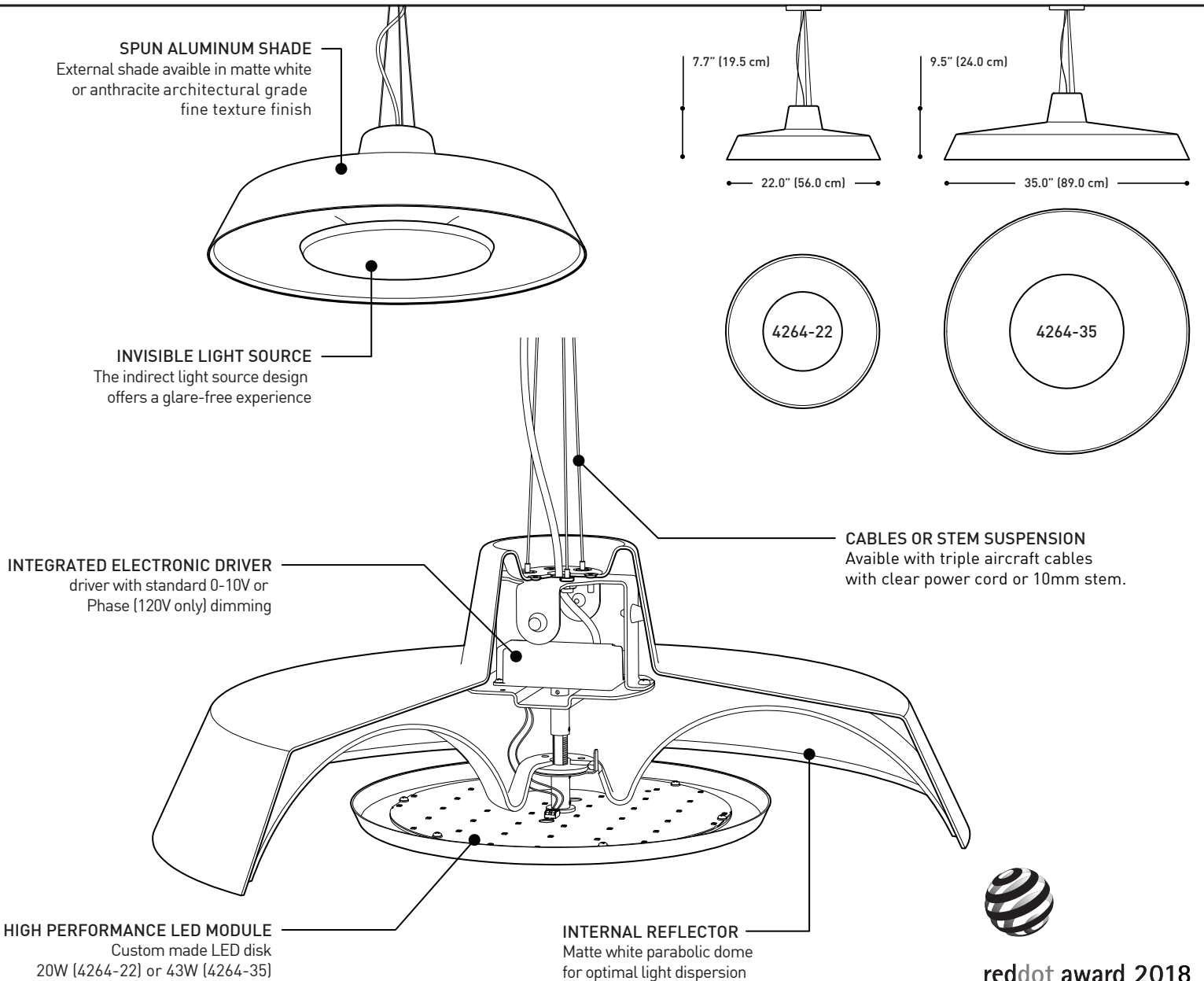

reddot award 2018
winner

SPECIFICATIONS	4264-22	4264-35
LIGHT SOURCE	44x Nichia mid-power LED	96x Nichia mid-power LED
MODULE	UL Recognized - Made in USA	
DELIVERED LUMENS	834lm	1925lm
FIXTURE SYSTEM WATTAGE	20W	43W
DIMMING	Phase or 0-10V dimming available	
CRI	85 CRI (typical)	
VOLTAGE	120V - 277V	
STRUCTURE	Spun aluminum shade, finished with an architectural grade fine texture paint in matte white or anthracite.	
REFLECTOR	Vacuum formed internal dome reflector in matte white	
WARRANTY	5 years	

ABAT-JOUR EN ALUMINIUM REPOUSSÉ

Coque externe disponible avec une peinture finement texturée de grade architectural blanc mat ou anthracite

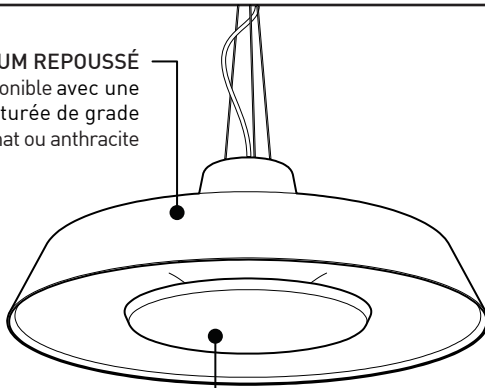

SOURCE LUMINEUSE INVISIBLE

Le design à source lumineuse indirecte offre une expérience sans éblouissement

PILOTE ÉLECTRONIQUE INTÉGRÉ

Pilote avec gradation standard 0-10V ou Phase (120V seulement)

MODULE DEL HAUTE PERFORMANCE

Disque DEL conçu sur mesure, 20W (4264-22) ou 43W (4264-35)

RÉFLECTEUR INTERNE

Coupole parabolique blanc mat pour une diffusion optimale

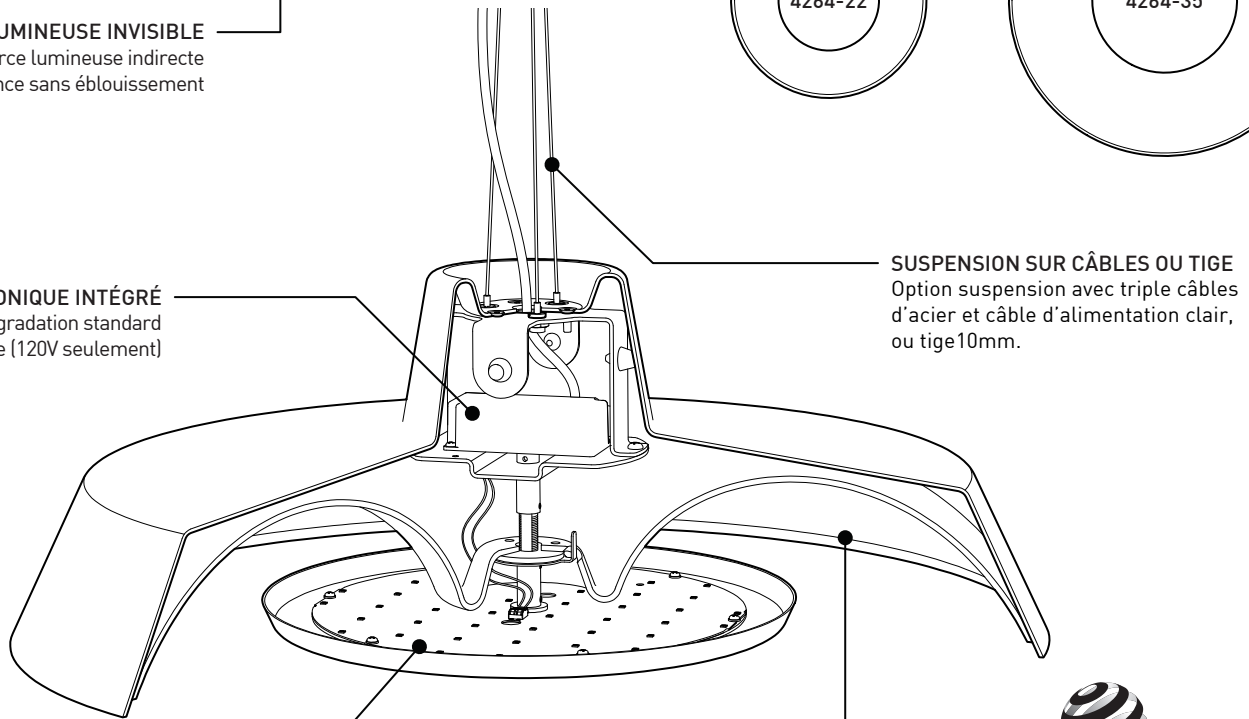
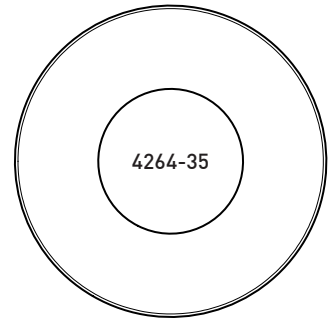
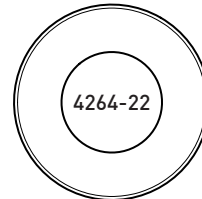
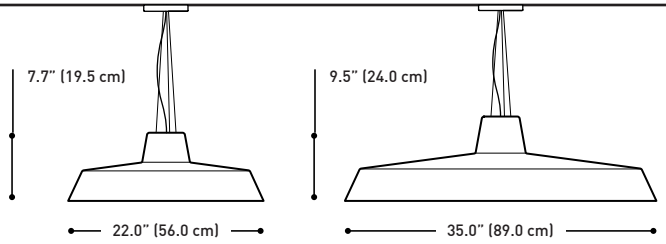

SUSPENSION SUR CÂBLES OU TIGE
Option suspension avec triple câbles d'acier et câble d'alimentation clair, ou tige 10mm.



reddot award 2018
winner

SPECIFICATIONS	4264-22	4264-35
SOURCE LUMINEUSE	44x DEL Nichia mi-puissance	96x DEL Nichia mi-puissance
MODULE	Reconnu UL - Fabriqué aux États-Unis	
LUMENS LIVRÉS	834lm	1925lm
PUISSANCE DU LUMINAIRE	20W	43W
GRADATION	Gradation Phase ou 0-10V disponible	
IRC	85 IRC (typique)	
VOLTAGE	120V - 277V	
STRUCTURE	Abat-jour en aluminium repoussé, fini avec une peinture blanc mat ou anthracite finement texturée de grade architectural	
RÉFLECTEUR	Réflecteur interne parabolique thermoformé en blanc mat	
GARANTIE	5 ans	