

VEGA 3738-TF

PROJECT PROJÉT
SPEC TYPE
NOTES



OPTIONS



WH3

WLT (WASHABLE)

GLT (WASHABLE)

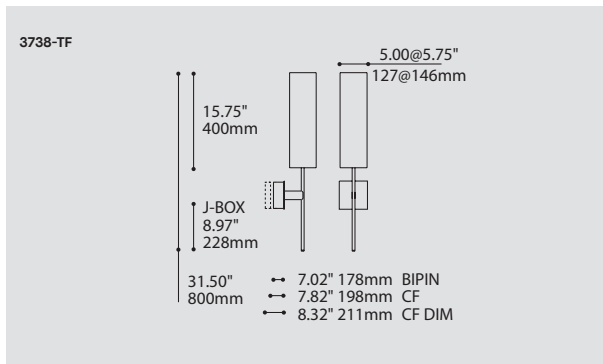

ORDERING SPECIFICATION	SPÉCIFICATION DE COMMANDE	CODE
MODEL MODÈLE	3738-TF VEGA TF	3738-TF
LIGHT SOURCE SOURCE LUMINEUSE	(WATTAGE, LAMP TYPE, LAMP FORM, BASE TYPE, OTHER INFO) CF.T.32 26/32W, CFL, DOUBLE / TRIPLE TWIN TUBE, G24Q3 BASE BIPIN.50 50W, HAL, BIPIN, GY6.35 BASE	
VOLTAGE VOLTAGE	120V 120 VOLT 277V 277 VOLT 347V* 347 VOLT <small>*ONLY AVAILABLE WITH CF.T.32 (NON-DIMMING BALLAST)</small>	
DIMMING OPTION OPTION DE GRADATION	AVAILABLE WITH CF.T.32 ONLY DM1 ADVANCE MARK 10 ELECTRONIC DIMMING BALLAST DM7 ADVANCE MARK 7 ELECTRONIC DIMMING BALLAST DED LUTRON ECOSYSTEM ELECTRONIC DIMMING BALLAST (ECOSYSTEM DIGITAL LINK WIRING) DE3 LUTRON ECOSYSTEM ELECTRONIC DIMMING BALLAST (3-WIRE WIRING)	
MOUNTING MONTAGE	SQC SQUARE CANOPY / PAVILLON CARRÉ FOR HAL: 1.00" CANOPY (2431E) FOR ELECTRONIC CFL: 1.75" CANOPY (2431G) FOR ELECTRONIC CFL DIMMABLE: 2.25" CANOPY (2431J)	SQC
STRUCTURE FINISH FINI STRUCTURE	S C SATIN CHROME CHR CHROME	
SHADE FINISH FINI ABAT-JOUR	WH3 WHITE - LINEN WLT WHITE - LINEN TRILAM GLT GRAY - LINEN TRILAM	

PRODUCT CHARACTERISTICS CARACTÉRISTIQUES DU PRODUIT



DESIGN:	Slim and elegant design for a contemporary or traditional setting.
INSTALLATION:	Must be installed shade up.
STRUCTURE:	Machined and tubular steel structure with plated finish.
DIFFUSER:	Range of washable and standard fabric shades available.
CERTIFIED:	c-CSA-us
CONCEPTION:	Forme élancée et élégante convenant autant aux décors contemporains que traditionnels.
INSTALLATION:	Le diffuseur doit être installé vers le haut.
STRUCTURE:	Structure d'acier tubulaire machinée et plaquée.
DIFFUSEUR:	Vaste gamme de tissus standards et lavables offerte.
CERTIFIÉ:	c-CSA-us

FAMILY FAMILLE



4211-TF

VEGA-XBL

ELEGANT

Vega is a fixture made to illuminate wall and spaces with a strong glow thanks to its diffusing tube. Multiple finish are available to customize it to your taste.

PURE BEAUTY

The finely sandblasted acrylic diffuser produces a fabulously charming glow.

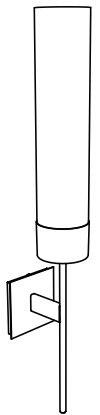

XBL

RAW POWER
A highly efficient 11.7W NICHIA COB at the center of every Vega-XBL ensure a strong lumen output.

TOUGH
A large aluminium heatsink integrated inside the frame provide cooling to the LEDs.

SIMPLE
The driver is accessibly located inside the junction box making it easier to perform its maintenance.

CLASS ACT
The chromed frame add a touch of prestige to the fixture and helps it to blend in its surrounding, picking up the colors of the environment.

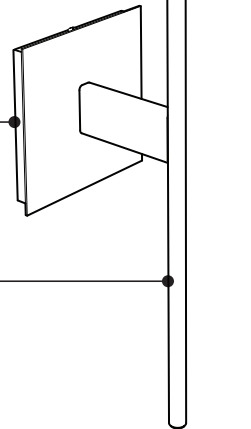

OFFERED VERSIONS

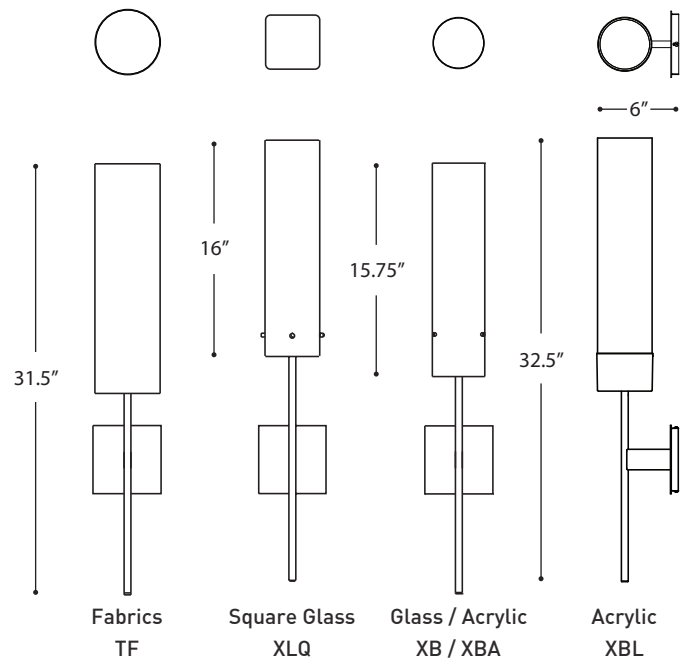

SPECIFICATIONS

	LED 11W	CF.D.13	CF.D.18	CF.T.32	BIPIN.50
LIGHT SOURCE	11W LED COB - System wattage : 13.9W	13W, CFL	18W, CFL	26/32W, CFL	50W, HAL, BIPIN
DELIVERED LUMENS	1260lm				
CRI	83 CRI (typical)				
LIGHT DISTRIBUTION	Diffused direct				
DIFFUSER	Closed top finely sandblasted acrylic (XBL)	XLQ only	XLQ, XB & XBA	XLQ, TF, XB & XBA	XLQ, TF, XB & XBA
STRUCTURE	Machined, spin formed & bent chromed steel				
MODULE	UL Recognized				
VOLTAGE	120V (DP) and 120-277V (DV)				120V
DRIVER	Constant Current 350mA, UL Recognized	Mark 7, Mark 10 or Lutron			N/A
DIMMING	Phase dimming (DP) or 0-10V dimming (DV)	Available*			N/A
LM-79	On request				
WARRANTY	5 years	2 years			1 year

*Please consult spec sheet & dimming guide for dimming informations

VEGA-XBL

ÉLÉGANT

Vega est un luminaire fait pour illuminer vos murs et vos espaces avec une puissante lueur grâce à son tube de diffusion. Plusieurs finis sont disponibles afin de l'adapter à vos préférences.

BEAUTÉ PURE

Le diffuseur d'acrylique finement texturé produit une illumination fabuleusement charmante.

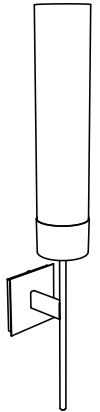

XBL

PUISSANCE VIVE

Un module de 11.7W hautement efficace situé au centre de chaque Vega-XBL assure un débit élevé de lumen.

ROBUSTE

Un large radiateur d'aluminium intégré à l'intérieur de la structure assure le refroidissement des DELs.

SIMPLE

L'unité d'alimentation est convenablement située dans la boîte de jonction afin d'en faciliter l'entretien.

CHIC

La structure chromée ajoute une touche de prestige au luminaire tout en lui permettant de mieux s'allier à son environnement en reflétant les multiples couleurs de celui-ci.

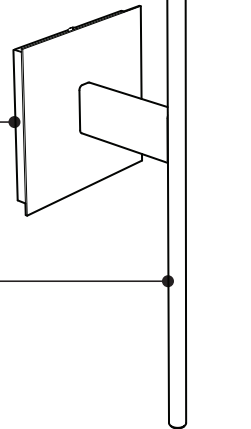

VERSIONS OFFERTES

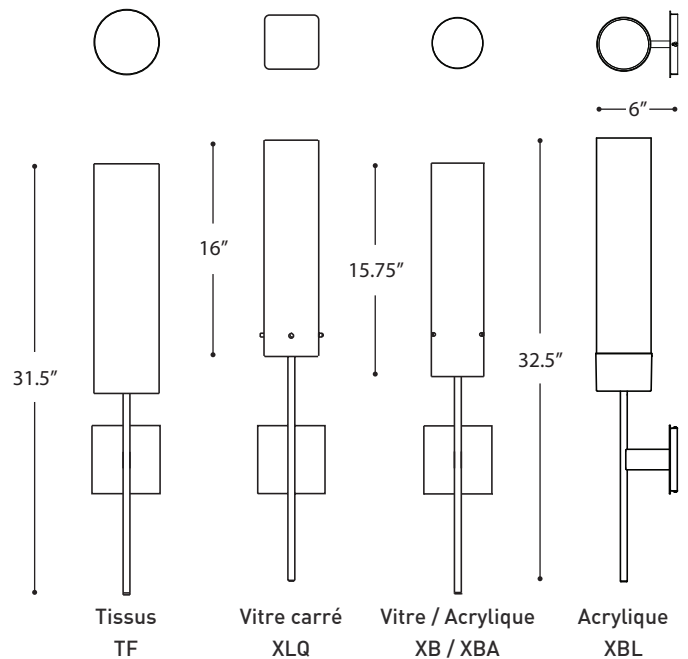

SPÉCIFICATIONS

	DEL 11W	CF.D.13	CF.D.18	CF.T.32	BIPIN.50
SOURCE LUMINEUSE	11W DEL COB - Consommation totale : 13.9W	13W, CFL	18W, CFL	26/32W, CFL	50W, HAL, BIPIN
LUMENS RÉELS	1260lm				
IRC	83 IRC (typique)				
DISTRIBUTION LUMINEUSE	Direct diffus				
DIFFUSEUR	Acrylique finement texturé avec dessus fermé (XBL)	XLQ seulement	XLQ, XB & XBA	XLQ, TF, XB & XBA	XLQ, TF, XB & XBA
STRUCTURE	Acier chromé machiné, repoussé et plié				
MODULE	Reconnu par UL				
VOLTAGE	120V (DP) et 120-277V (DV)				120V
UNITÉ D'ALIMENTATION	Courant Constant 350mA, Reconnu UL	Mark 7, Mark 10 ou Lutron			N/A
GRADATION	Gradation phase (DP) ou gradation 0-10V (DV)	Offert*			N/A
LM-79	Sur demande				
GARANTIE	5 ans	2 ans			1 an

*Consulter la fiche technique et le guide de gradation pour accéder à plus d'informations