

HELIOS 3202B

PROJECT PROJET

SPEC TYPE

NOTES

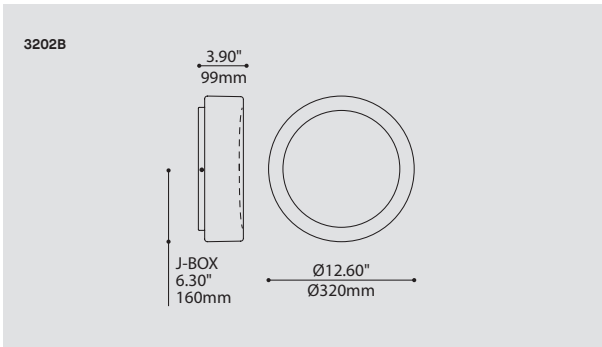
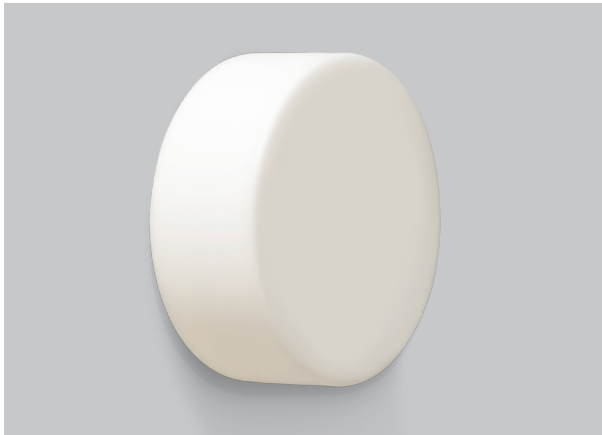

ORDERING SPECIFICATION SPÉCIFICATION DE COMMANDE

CODE

MODEL MODÈLE

3202B HELIOS

3202B

LIGHT SOURCE SOURCE LUMINEUSE

(WATTAGE, LAMP TYPE, LAMP FORM, BASE TYPE, OTHER INFO)

CF.D.26  26W, CFL, DOUBLE / TRIPLE TWIN TUBE, G24Q3 BASE

2XCF.SP.13  13W X 2, CFL, SPIRAL TUBE, GU24 BASE (120V ONLY)

F.T5.C.22  22W, FLUO, CIRCULAR T5, 2GX13 BASE

LED.10  10W, LED

COLOR TEMPERATURE TEMPÉRATURE DE COULEUR

FOR LED ONLY

30 3000K

35 3500K

40 4000K

VOLTAGE VOLTAGE

120V 120 VOLT

277V 277 VOLT

347V* 347 VOLT

*ONLY AVAILABLE WITH CF.D.26, F.T5.C.22, (NON-DIMMING BALLAST)

DIMMING OPTION OPTION DE GRADATION

AVAILABLE WITH CF.D.26 ONLY

DM1 ADVANCE MARK 10 ELECTRONIC DIMMING BALLAST*

DM7 ADVANCE MARK 7 ELECTRONIC DIMMING BALLAST*

DED LUTRON ECOSYSTEM ELECTRONIC DIMMING BALLAST (ECOSYSTEM DIGITAL LINK WIRING)*

DE3 LUTRON ECOSYSTEM ELECTRONIC DIMMING BALLAST (3-WIRE WIRING)*

AVAILABLE WITH LED ONLY

DV 0-10V DIMMING (120-277V)*

DP PHASE DIMMING (120V ONLY)*

LED DIMMING DRIVER IS STANDARD IN THIS PRODUCT, PLEASE SPECIFY YOUR DIMMING TYPE.

DIFFUSER FINISH FINI DIFFUSEUR

WH WHITE

WH

PRODUCT CHARACTERISTICS CARACTÉRISTIQUES DU PRODUIT

ADA BIM DIM IES LED

DESIGN: Round bright shade design with concave front surface. ADA compliant.

LIGHT SOURCE: Wide range of energy saving compact fluorescent and LED light sources available.

STRUCTURE: Die-stamped steel structure with highly reflective and diffused white paint finish.

DIFFUSER: Hand blown white triplex glass.

CERTIFIED: c-CSA-us, c-UL-us

CONCEPTION: Verre rond et brillant avec façade concave. Conforme à la norme ADA.

SOURCE LUMINEUSE: Plusieurs sources fluorescentes et DEL à faible consommation offertes.

STRUCTURE: Structure d'acier embouti avec fini blanc très réfléchissant et diffusant.

DIFFUSEUR: Verre triplex blanc soufflé à la main.

CERTIFIÉ: c-CSA-us, c-UL-us

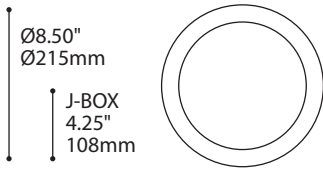

3202 (LED NOT AVAILABLE)

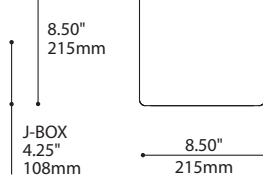

3203 (LED NOT AVAILABLE)

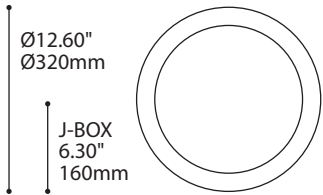

3202B

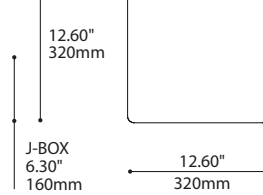

3203B

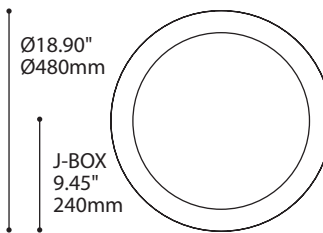
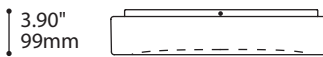

3202C

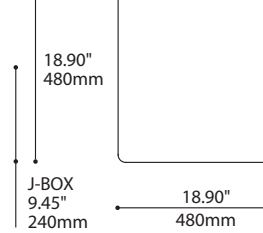
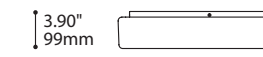

3203C

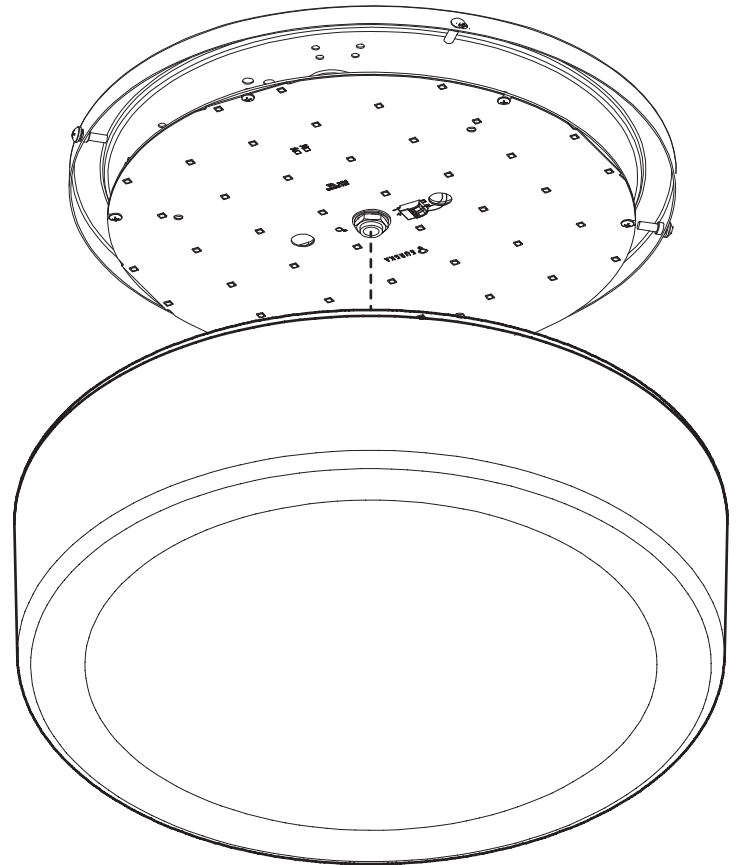

SPECIFICATIONS

3202 | 3203

3202B | 3203B

3202C | 3203C

LIGHT SOURCES

CF.D.13
CF.SP.13
G9.60

CF.D.26
2XCF.SP.13
F.T5.C.22
LED.10.30
LED.10.40

2CF.D.26
3XCF.SP.13
F.T5.C.2240
F.T5.C.2240-2C
F.T5.C.40
LED.10.30
LED.10.40

DIMMING OPTIONS

DV 0-10V (120-277V), DP PHASE DIMMING (120V), DM1, DM7, DED, DE3

VOLTAGE

120V, 277V, 347V (347 only with CF.D.13, CF.D.26, F.T5.C.22, F.T5.C.2240, F.T5.C.2240-2C & F.T5.C.40 [non dimming ballast])

STRUCTURE

Die-stamped steel structure with highly reflective and diffused white paint finish.

DIFFUSER

Hand blown white triplex glass

CERTIFICATION

c-CSA-us

WARRANTY

5 year warranty on LED fixtures, 1 year warranty on fluorescent fixtures



225 de Liège Ouest, Suite #200
Montréal (QC), Canada H2P 1H4
Tel : 514.385.3515 Fax : 514.385.4169
www.eurekalighting.com



3202
3203

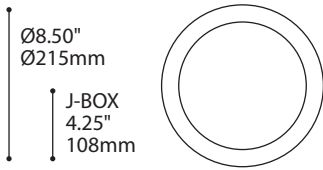

3202 (NON DISPONIBLE EN DEL)

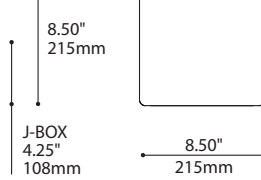

3203 (NON DISPONIBLE EN DEL)

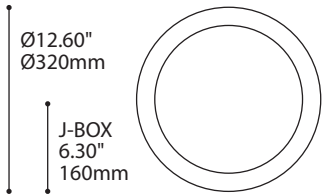

3202B

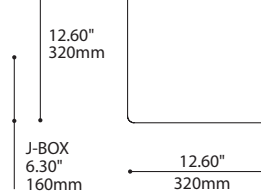
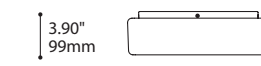

3203B

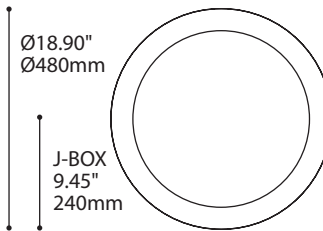
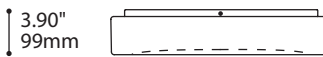

3202C

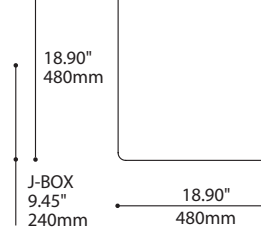
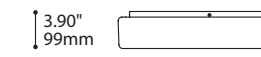

3203C

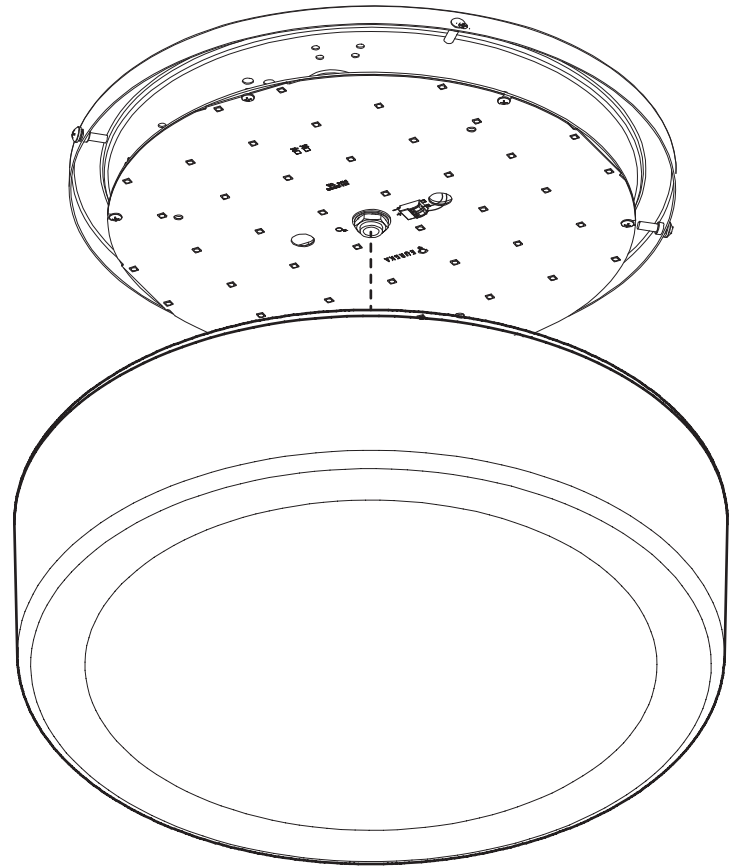

SPECIFICATIONS

SOURCE LUMINEUSE

3202 | 3203

CF.D.13
CF.SP.13
G9.60

3202B | 3203B

CF.D.26
2XCF.SP.13
F.T5.C.22
LED.10.30
LED.10.40

3202C | 3203C

2CF.D.26
3XCF.SP.13
F.T5.C.2240
F.T5.C.2240-2C
F.T5.C.40
LED.10.30
LED.10.40

OPTIONS DE GRADATION

DV 0-10V (120-277V), GRADATION DP PHASE (120V), DM1, DM7, DED, DE3

VOLTAGE

120V, 277V, 347V (347 seulement avec CF.D.13, CF.D.26, F.T5.C.22, F.T5.C.2240, F.T5.C.2240-2C & F.T5.C.40 [sans gradation])

STRUCTURE

Structure en acier formé, fini à la peinture électrostatique blanc hautement réfléchissant.

DIFFUSEUR

Verre soufflé triplex blanc

CERTIFICATION

c-CSA-us

GARANTIE

Garantie de 5 ans sur le luminaire en DEL, Garantie de 1 an sur les luminaires en fluorescent



225 de Liège Ouest, Suite #200
Montréal (QC), Canada H2P 1H4
Tel : 514.385.3515 Fax : 514.385.4169
www.eurekalighting.com



3202
3203