

12540-1X1

PROJECT PROJÉT

SPEC TYPE

NOTES

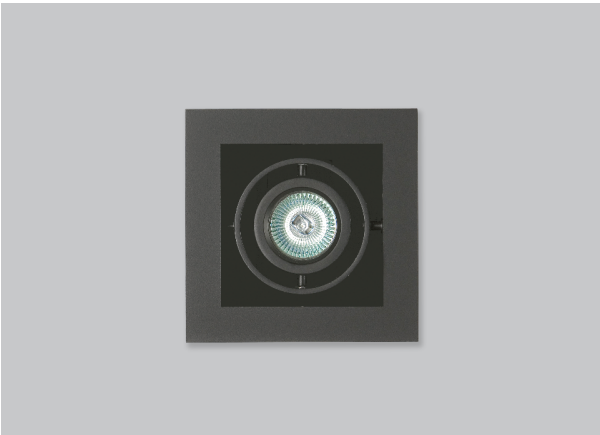

FINISH COMBINATIONS COMBINAISONS DE FINIS



M G-M G-BLK



WH-BLK-BLK



WH-WH-WH



BLK-BLK-BLK

159X REMODELING 159X RÉNOVATION

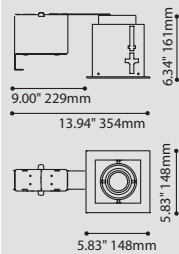

□ 4.9" x 4.9"
(124mm x 124mm)

169X NEW CONSTRUCTION 169X NOUVELLE CONSTRUCTION

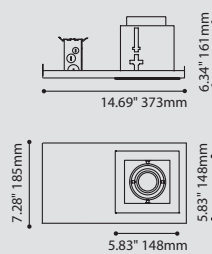

ORDERING SPECIFICATION SPÉCIFICATION DE COMMANDE

CODE

MODEL MODÈLE

12540-1X1 BASS 1X1

12540-1X1

HOUSINGS BOÎTIERS

159X REMODELING
169X NEW CONSTRUCTION

LIGHT SOURCE SOURCE LUMINEUSE

MR16.50.E  50W, HAL, MR16, GU5.3 BASE
MR16LED.16.E  16W MAX., LED, MR16, GU5.3 BASE
LED.4  4W, LED
LED.8  8W, LED
LED.11  11W, LED

COLOR TEMPERATURE TEMPÉRATURE DE COULEUR

FOR LED ONLY
30 3000K
35 3500K
40 4000K

ANGLE BEAM ANGLE DE FAISCEAU

FOR LED ONLY
LED.4 / LED.8
17 17°
48 48°

LED.11
20 20°
40 40°

VOLTAGE VOLTAGE

120V 120 VOLT
277V* 277 VOLT
*NOT AVAILABLE IN LED 8W WITHOUT DV DRIVER OPTION

DIMMING OPTION OPTION DE GRADATION

AVAILABLE WITH LED ONLY
DV 0-10V DIMMING (120V-277V)
DP PHASE DIMMING (120V ONLY)
LED DIMMING DRIVER IS OPTIONAL FOR 12540-1X1 4W & 8W AND STANDARD FOR 12540-1X1 11W, 12540-2X1, 12540-2X2, 12540-3X1 AND 12540-4X1, PLEASE SPECIFY YOUR DIMMING TYPE.

TRIM FINISH FINI CADRE

BLK BLACK
M G METALLIC GRAY
WH WHITE

RING FINISH FINI ANNEAUX

BLK BLACK
M G METALLIC GRAY
WH WHITE

ENCLOSURE FINISH FINI BOÎTIER

BLK BLACK
WH WHITE

ACCESSORY ACCESSOIRE

19540-1X1 FLUSH™ MOUNTING ACCESSORY (FOR 12540-1X1)

PRODUCT CHARACTERISTICS CARACTÉRISTIQUES DU PRODUIT



The contemporary and functional Bass multiple recessed fixture, features up to four fully directional light sources in both linear and square formats. Available with both standard and high performance Eureka LED modules with optional phase dimming (DP - 120V only) and 0-10V dimming (DV), as well as, MR16 lamp types (LED retrofit or halogen). Dimming is available for all light sources. To maximize design flexibility, the rings and the finish trim of the Bass are available in black, white or metallic gray, while the enclosure is offered in reflective white or discreet black. Using our patented automatically locating mounting clip, Bass is designed for quick installation in both new construction ceilings (169X) or when remodeling (159X) in an existing ceiling. When time is tight the 169X new construction option can be split so that the mounting plate and connection box with quick-connect are shipped in advance of the fixture housing. For a clean look without the hassle of a trim-less installation, the Bass fixture can be installed using our Flush™ mounting accessory (19540).

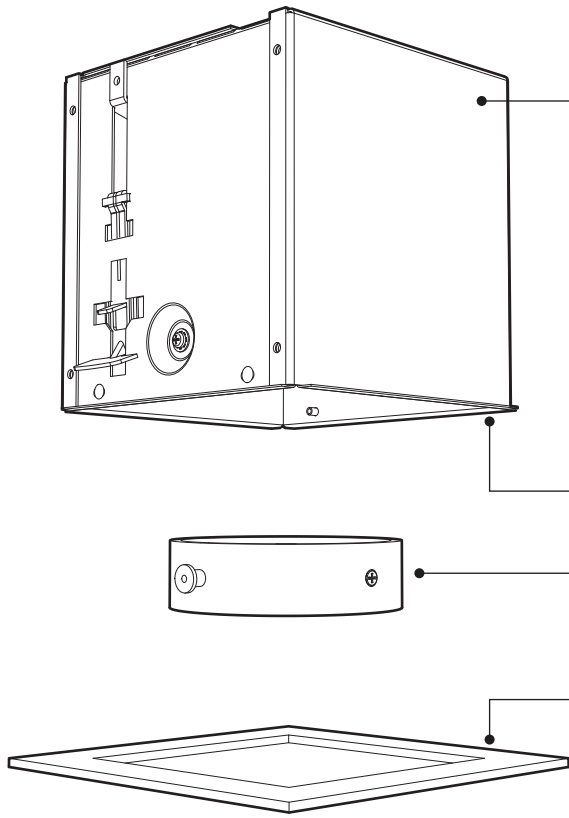

CONTEMPORARY DESIGN

Recessed multiple fixture. Features up to 4 fully directional light sources in 5 versatile configurations.

LIGHT SOURCES

HAL: 50W
CMH: 16W
LED: 4W / 8W / 11W
(Optional dimming available with Led)

18 POSSIBLE FINISH COMBINATIONS:

ENCLOSURE

Discreet black / Reflective white

RING

Black / White / Metallic gray
Independent and fully aimable

TRIM

Black / White / Metallic gray
Highly decorative, or can be hidden

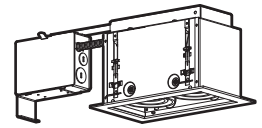

REMODELING OPTION

Unique automatically locating mounting clips for quick installation

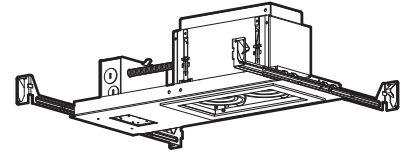

NEW CONSTRUCTION OPTION

Mounting plate available for split shipping in advance

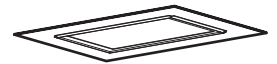

FLUSH™ MOUNTING ACCESSORY

Quick and clever design for a trim-less look

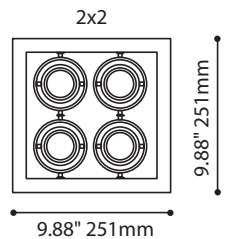
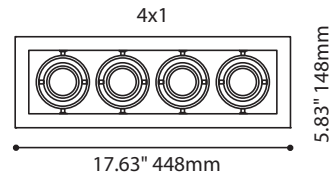
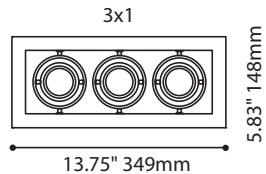
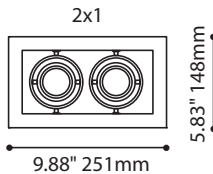
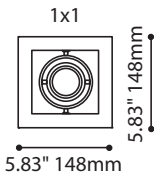

SPECIFICATIONS

	LED 4W	LED 8W	LED 11W
LIGHT SOURCE	4 x Nichia	4 x Nichia	1 x Nichia Chip On Board (COB)
OPTIC	TIR - 20° & 38° total beam angle	TIR - 20° & 38° total beam angle	TIR - 20° & 40° total beam angle
MODULE	UL recognized - made in USA		
LUMENS (DELIVERED)	400 lm (4000K)	715 lm (4000K)	1000 lm (4000K)
EFFICIENCY	100 lm/w (4000K)	90 lm/w (4000K)	90 lm/w (4000K)
CCT	ANSI 4000K 3-Step MacAdam Ellipse Binning		
CRI	84 CRI (typical)	84 CRI (typical)	83 CRI (typical)
DRIVER (NON-DIMMING)	350 mA Constant Current	700mA Constant Current	350 mA Constant Current
DRIVER (DIMMING)	0-10V Dimming (DV) / Phase Dimming (DP)		
VOLTAGE	120V or 277V		
L70 / LM-79	50 000 hrs / On request	50 000 hrs / On request	50 000 hrs / On request
CERTIFICATION / WARRANTY	c-UL-us / 5 year		

*Please consult factory for dimming & controller options.



225 de Liège Ouest, Suite #200
Montréal (QC), Canada H2P 1H4
Tel : 514.385.3515 Fax : 514.385.4169
www.eurekalighting.com



12540-XXX
BASS

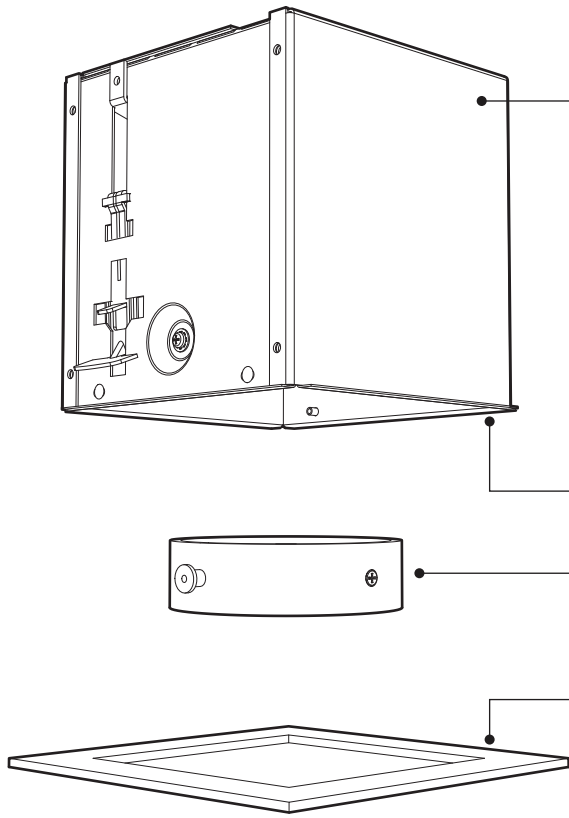

DESIGN CONTEMPORAIN

L'encastré multiple Bass comprend quatre lampes orientables en configuration linéaire ou carrée.

SOURCE LUMINEUSE

HAL: 50W
 CMH: 16W
 LED: 4W / 8W / 11W
 (DEL offertes avec options de gradation)

18 COMBINAISONS DE FINITION POSSIBLES:

BOITIERS

Noir / Blanc réfléchissant

ANNEAUX

Noir discret / Blanc / Gris métallique
 Indépendants et directionnels

CADRES

Noir / Blanc / Gris métallique
 Décoratifs ou cachés

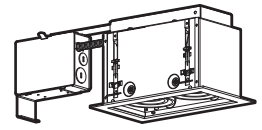

RÉNOVATION

Système breveté exclusif de fixation pour installation rapide

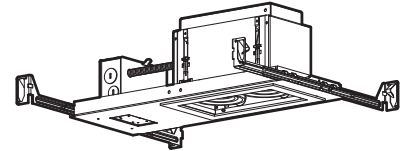

NOUVELLE CONSTRUCTION

La plaque de montage peut être expédié séparément du boîtier, afin d'anticiper l'installation du gypse

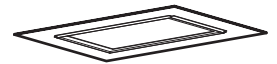

L'ACCESSOIRE DE MONTAGE FLUSH™

Conception rapide et intelligent pour un look sans bordure

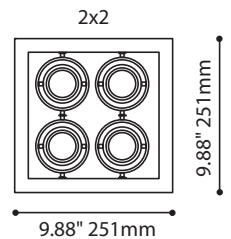
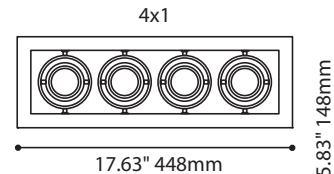
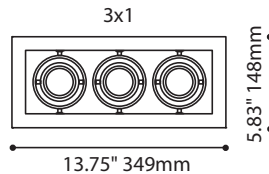
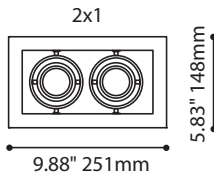
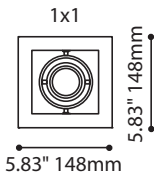

CARACTÉRISTIQUES

	LED 4W	LED 8W	LED 11W
SOURCE LUMINEUSE	4 x Nichia	4 x Nichia	1 x Nichia Chip On Board (COB)
OPTIQUE	TIR - 20° & 38° angle de faisceau	TIR - 20° & 38° angle de faisceau	TIR - 20° & 40° angle de faisceau
MODULE	UL reconnu- Fabriqué aux États-Unis		
LUMENS (RÉELS)	400 lm (4000K)	715 lm (4000K)	1000 lm (4000K)
EFFICACITÉ	100 lm/w (4000K)	90 lm/w (4000K)	90 lm/w (4000K)
CCT	ANSI 4000K 3-Step MacAdam Ellipse Binning		
IRC	84 CRI (typique)	84 CRI (typique)	83 CRI (typique)
PILOTE (SANS GRADATION)	350 mA Courant Constant	700mA Courant Constant	350 mA Courant Constant
PILOTE (GRADATEUR)	0-10V Gradation (DV) / Gradation Phase (DP)		
VOLTAGE	120V or 277V		
L70 / LM-79	50 000 hrs / Sur demande	50 000 hrs / Sur demande	50 000 hrs / Sur demande
CERTIFICATION / GARANTIE	c-UL-us / 5 ans		

*Veuillez communiquer avec votre représentant pour la liste de gradateurs compatibles.