

MSO - microgroove spotless lens

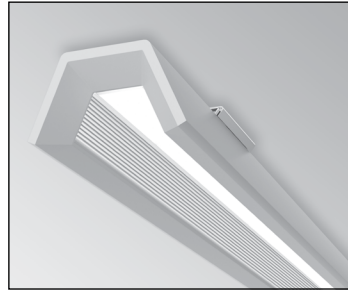

MAL - microgroove aluminum

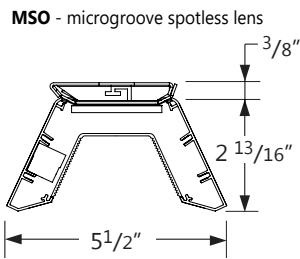

MSO - microgroove spotless lens

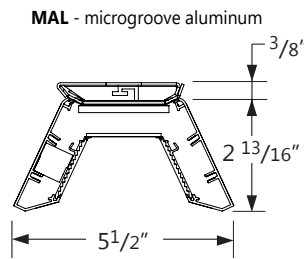

MAL - microgroove aluminum

Project _____

Type _____

Notes _____

		NOMINAL LUMENS/FT	
		SL 0/100	INPUT WATTS
		Lumens/ft	W/ft
MSO		950	11.8
		650	7.9
		500	5.9
		1000	15.7
		750	11.8
MAL		500	7.9
		800	11.8
		550	7.9
		400	5.9
		850	15.7
	650	11.8	
	450	7.9	

90 CRI only
80 CRI only

REFER TO PHOTOMETRIC DATA SECTION FOR EXACT VALUES
*Lumen values are based upon a white finish, lumen values may vary for custom finishes



Ordering Guide

ZESLED	PRODUCT ID	LIGHT ENGINE	NOMINAL LUMENS/FT	CRI	COLOR TEMP.	SHIELDING	SHIELDING FINISH (OPTIONAL)
ZESLED Surface LED	SL 0/100	surroundlite 0%up/100%down-direct	##	80 80 CRI 90 90 CRI	27 2700 K 30 3000 K 35 3500 K 40 4000 K	MSO microgroove spotless lens MAL microgroove aluminum ⁽¹⁾	W white - standard C custom
			See table above for lumen selection. Applies to both UP&DOWN. Consult factory for other lumen packages.			(1) Standard white	Shielding finish option is for MAL option only.

FIXTURE LENGTH	FINISH	VOLTAGE	DRIVER	CIRCUITS
2 2' 3 3' 4 4' 5 5' 6 6' 7 7' 8 8' 12 12'	AP aluminum paint W white BLK black C custom	UNV universal	MD integral mini driver 0-10V dimming 2%	1 1 circuit 2 2 circuits 2A/B 2 circuit alternating/4ft +E(##) emergency section
Come in 1' increments System runs not available		Consult factory for 347 V	Only integral 0-10V mini driver available	

MOUNTING/SUSPENSION	BATTERY (OPTIONAL)	REMOTE CONTROLS (OPTIONAL)	CUSTOM
S surface ceiling	B# remote battery pack	DS# daylight sensor DOS# daylight & occupancy sensor WC# wireless control dimming	C custom
	Not available with 347V Please consult factory	Remote only. See integrated controls guide for more details.	Please specify



● SURROUNDLITE TECHNOLOGY

ZEN with SurroundLite provides the flexibility of high efficacy spherical three dimensional wide batwing distributions and shielding options that all result in true lighting effectiveness. ZEN with integral mini driver and a light guide with proper cutoff and no view of bugs or dust particles.

An innovative technology to get much more out of LEDs: Axis SurroundLite is based on the fundamental physics of how light interacts with matter. The specially engineered lightguide is made of precisely coded and aligned molecules that shape LED output in all three dimensions.

With SurroundLite extra-wide, multidimensional light distribution, light is directed in all three planes and sent in every corner of the room. SurroundLite brings the promise of balanced brightness, facilitating lighting design.



3D Polar Curve (SL 0/100)

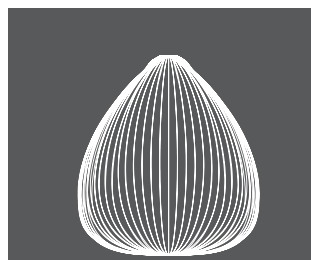

● UNIQUE ZEN SHIELDING OPTIONS

A new linear downlight optical concept. A central surroundlite lightguide optic with highly efficient and comfortable micro groove side wall shielding for excellent shielding along and across.

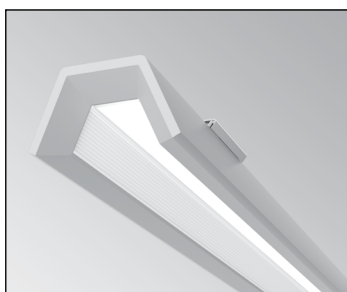

MSO - microgroove spotless lens

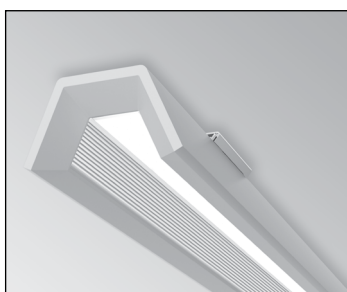

MAL - microgroove aluminum



● LIGHT GUIDE

High precision light guide made of PMMA material, allows distribution of controlled light in all 3-dimensions to put light on both vertical and horizontal planes within the space. Patented lightguide design featuring molecular optics and precision-coupled optic components yield a high efficiency luminaire. In-plane mixing maximizes color uniformity while light emitting area is uniform and diffuse without 'head lighting' from the LED's.

● LENGTHS

ZEN 4ft (4)

ZEN 4ft

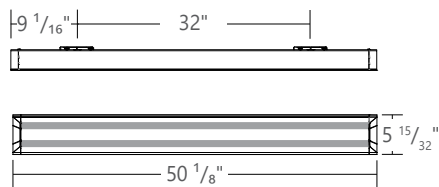

ZEN 8ft

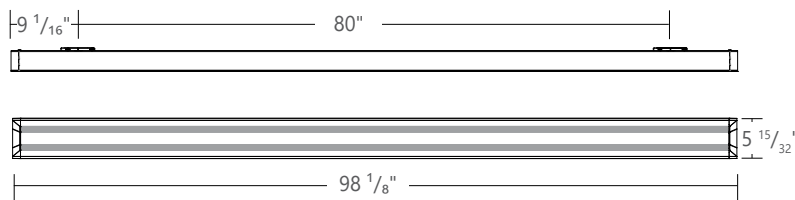

ZEN 12ft

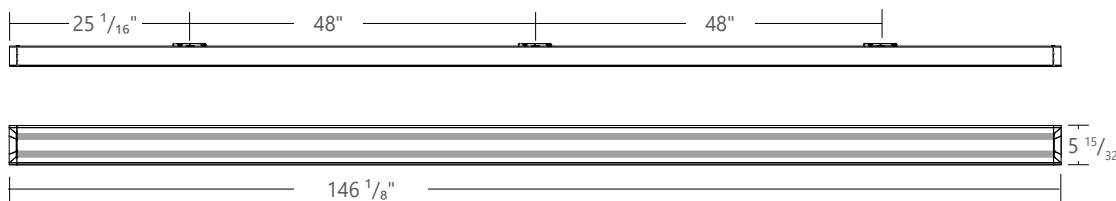

● OPTICS



MSO microgroove
spotless lens

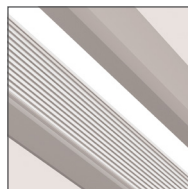

MAL microgroove
aluminum

● WEIGHT

ZEN 4 ft 9 lbs / 4.1 kg
ZEN 8 ft 18 lbs / 8.2 kg
ZEN 12 ft 27 lbs / 12.3 kg

● FINISH

White, black, aluminum paint, powder coated and custom finishes are also available.

● APPROVALS

Certified to UL and CSA standards
 Suitable for damp locations.





● MOUNTING

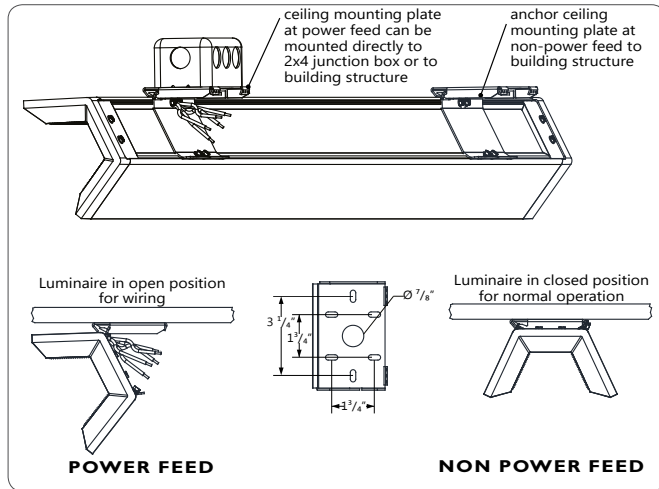

S SURFACE MOUNT

● CONSTRUCTION

Housing	Extruded aluminum (0.075" nominal)
End Cap	Die cast aluminum (0.10" nominal)
Mounting Brackets	Cold rolled sheet steel painted (16 gauge)
Interior Bracket	Die cast aluminum
Microgroove Lens	Uniform frosted acrylic lens
Microgroove Aluminum	White painted aluminum material

● ELECTRICAL

Emergency	Remote emergency battery pack or emergency circuit optional.
Input Voltage	UNV

i Incorporating these components may have limitations or affect the length of the luminaire. Please contact factory for more details.

● LED UPGRADE / REPLACEMENT

All LED light engines used are field replaceable and upgradable to ensure the lighting system will last for years. Future-proof design comes with easy access to LED light engines from above using quick connectors (included in luminaire) and a screwdriver.

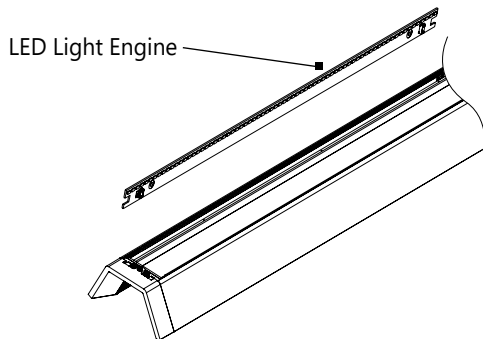

● LED SYSTEM

CRI	Minimum 80 or 90 color rendering index
CCT	Choice of 3000K, 3500K and 4000K color temperature with a great color consistency (within 3-step MacAdam ellipse). Both within fixture and fixture to fixture.
LED life	Minimum 50,000h with 85% of lumen maintenance in 25°C ambient temperature, in compliance with IES LM-80 testing measurements.
Thermal Management	Aluminum housing acting as the heat sink to maximize life.
Environment	Dry and damp rated in operating ambient temperatures of 0-40°C (32-104F)



● PHOTOMETRIC DATA

Microgroove Spotless Lens (MSO)

ZELED-SL0-100-500-80-35-MSO-4-W-UNV-MD-1.ies
0% up / 100% down at 500 lm/ft

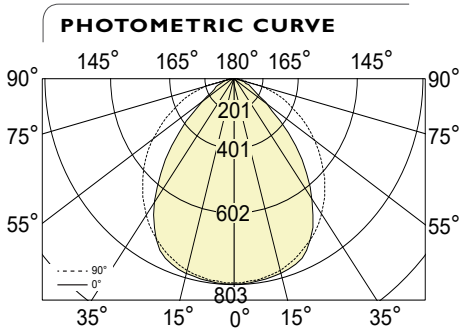

Lumen/ft up: 0 lm/ft
Lumen/ft down: 478 lm/ft
Total Lumens: 1912 lm (for 4ft)
Input Watts: 23.6 W
Efficacy: 81 lm/W

CRI: 80 shown
ZELED-SL0-100-500-80-35-MSO-4-W-UNV-MD-1.ies
TESTED ACCORDING TO IES LM-79-2008

CANDELA DISTRIBUTION

Vertical Angle	Horizontal Angles				
	0	22.5	45	67.5	90
0	803	803	803	803	803
5	801	801	800	800	800
15	787	785	782	779	778
25	739	743	740	733	730
35	585	606	652	658	655
45	372	405	485	556	552
55	166	192	289	412	429
65	80	85	117	239	292
75	37	39	51	82	153
85	5	5	10	19	32
90	0	1	3	6	1

ZONAL LUMENS

Zone	Lumens
0	
0-10	76
10-20	221
20-30	339
30-40	395
40-50	367
50-60	268
60-70	157
70-80	72
80-90	17
90	

LUMINANCE DATA (cd/m²)

Vertical Angle	Horizontal Angles		
	0	45	90
45	5203	4936	5116
55	2817	3211	4243
65	1807	1488	3210
75	1271	780	1949
85	387	193	500

Microgroove Spotless Lens (MSO)

ZELED-SL0-100-950-80-35-MSO-4-W-UNV-MD-1.IES
0% up / 100% down at 950 lm/ft

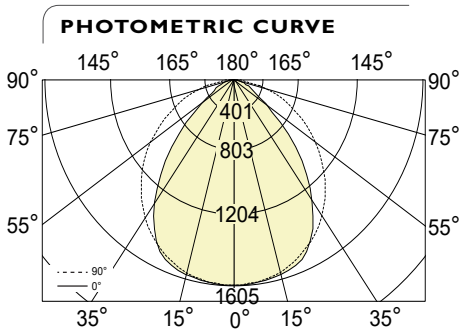

Lumen/ft up: 0 lm/ft
Lumen/ft down: 956 lm/ft
Total Lumens: 3824 lm (for 4ft)
Input Watts: 47.23 W
Efficacy: 81 lm/W

CRI: 80 shown
ZELED-SL0-100-950-80-35-MSO-4-W-UNV-MD-1.IES
TESTED ACCORDING TO IES LM-79-2008

CANDELA DISTRIBUTION

Vertical Angle	Horizontal Angles				
	0	22.5	45	67.5	90
0	1605	1605	1605	1605	1605
5	1602	1602	1600	1600	1599
15	1573	1570	1563	1557	1555
25	1478	1486	1480	1466	1461
35	1171	1211	1303	1317	1310
45	745	810	970	1112	1104
55	332	385	577	825	857
65	161	170	234	479	585
75	73	78	102	163	305
85	9	10	19	39	63
90	1	1	6	12	3

ZONAL LUMENS

Zone	Lumens
0	
0-10	152
10-20	442
20-30	678
30-40	790
40-50	733
50-60	535
60-70	315
70-80	145
80-90	34
90	

LUMINANCE DATA (cd/m²)

Vertical Angle	Horizontal Angles		
	0	45	90
45	10406	9871	10233
55	5634	6422	8486
65	3614	2976	6421
75	2542	1560	3898
85	775	386	1001

i All IES files are available for download at: www.axislighting.com



● PHOTOMETRIC DATA

Microgroove Aluminium (MAL)

ZELED-SLO-100-400-80-35-MAL-4-W-UNV-MD-1.ies
0% up / 100% down at 400 lm/ft

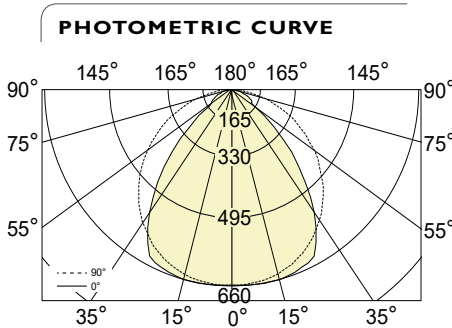

Lumen/ft up: 0 lm/ft
Lumen/ft down: 399 lm/ft
Total lumens: 1596 lm (for 4ft)
Input Watts: 23.4 W
Efficacy: 68 lm/W

CRI: 80 shown
IES FILE: ZELED-SLO-100-400-80-35-MAL-4-W-UNV-MD-1.ies
TESTED ACCORDING TO IES LM-79-2008

CANDELA DISTRIBUTION

Vertical Angle	Horizontal Angles				
	0	22.5	45	67.5	90
0	658	658	658	658	658
5	659	658	657	656	656
15	658	656	649	642	639
25	640	635	624	609	602
35	504	527	572	553	541
45	298	332	417	473	458
55	94	131	232	368	358
65	68	69	71	204	246
75	33	35	42	55	130
85	3	3	8	15	29
90	0	0	2	5	1

ZONAL LUMENS

Zone	Lumens
0	
0-10	63
10-20	183
20-30	287
30-40	338
40-50	308
50-60	216
60-70	127
70-80	60
80-90	14
90	

LUMINANCE DATA (cd/m²)

Vertical Angle	Horizontal Angles		
	0	45	90
45	4166	4244	4246
55	1602	2578	3540
65	1524	903	2701
75	1136	649	1662
85	220	160	463

Microgroove Aluminium (MAL)

ZELED-SLO-100-800-80-35-MAL-4-W-UNV-MD-1.ies
0% up / 100% down at 800 lm/ft

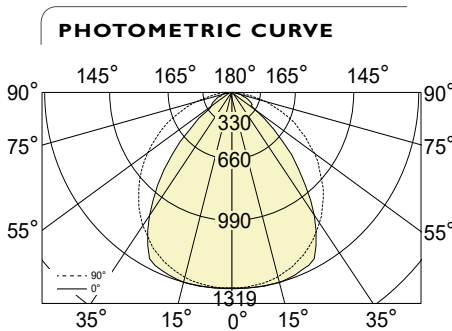

Lumen/ft up: 0 lm/ft
Lumen/ft down: 798 lm/ft
Total lumens: 3191 lm (for 4ft)
Input Watts: 46.9 W
Efficacy: 68 lm/W

CRI:80 shown
IES FILE: ZELED-SLO-100-800-80-35-MAL-4-W-UNV-MD-1.ies
TESTED ACCORDING TO IES LM-79-2008

CANDELA DISTRIBUTION

Vertical Angle	Horizontal Angles				
	0	22.5	45	67.5	90
0	1316	1316	1316	1316	1316
5	1318	1317	1315	1312	1312
15	1317	1311	1298	1284	1278
25	1280	1270	1248	1218	1204
35	1007	1054	1144	1107	1083
45	596	664	834	946	916
55	189	262	464	735	715
65	136	138	142	409	492
75	65	70	85	110	260
85	5	7	16	31	59
90	1	1	4	9	2

ZONAL LUMENS

Zone	Lumens
0	
0-10	125
10-20	367
20-30	573
30-40	676
40-50	616
50-60	431
60-70	254
70-80	120
80-90	28
90	

LUMINANCE DATA (cd/m²)

Vertical Angle	Horizontal Angles		
	0	45	90
45	8332	8487	8492
55	3205	5157	7080
65	3048	1806	5403
75	2271	1297	3325
85	441	320	927

i All IES files are available for download at: www.axislighting.com