



WALL MOUNT

PROJECT INFORMATION

Project:

Type:

Notes:

DIMENSIONS

SECTION VIEWS

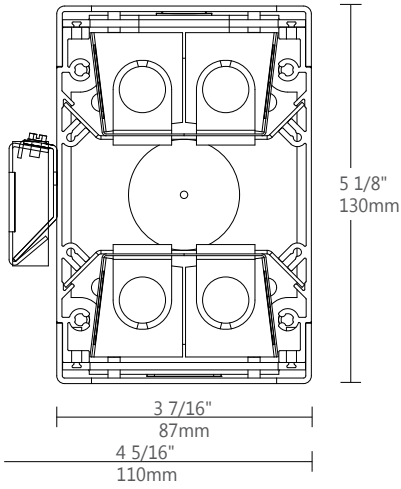

ORDERING CODE

1	2	3	4	5	6	7	8	9	10	11	12	13
---	---	---	---	---	---	---	---	---	----	----	----	----

PRODUCT SPECIFICATIONS

1 PRODUCT ID	2 OPTICS	3 LENGTH/FT	4 LAMP	5 DOWN LAMP	6 UP LAMP
WBDIW wall	S satin lens F frosted lens AV clear anti-vandal polycarbonate PL semi spec para. louvers ⁽¹⁾	2 2' 3 3' 4 4' 6 6' 8 8' 12 12' S# System Run	T5 T5 T5HO T5HO T8 T8	0 0 lamp 1 1 lamp 2 2 lamps ⁽²⁾	0 0 lamp 1 1 lamp 2 2 lamps ⁽³⁾
(1) Available only with an AV lens not available in up lamp			(2) Not available for T8 lamp		(3) Not available for T8 lamp

7 FINISH	8 VOLTAGE	9 BALLAST	10 CIRCUITS	11 BATTERY (OPTIONAL)
AP aluminum paint W white BLK black C custom	120 120V 277 277V 347 347V ⁽⁴⁾ UNV universal	D dimming E instant start ⁽⁵⁾ ERS program start BI bi-level dimming	1 1 regular 2 2 regular 2A/B 2 alternating +E(#) emergency section +NL(#) night light section +GTD(#) generator transfer device	B# battery pack 4' sections
(4) Please consult factory		(5) Available with T8 lamp only	Requires 120V or 277V	

12 OTHER (OPTIONAL)	13 CUSTOM (OPTIONAL)
F fuse EF end feed	C custom
Please specify	



● MOUNTING OPTIONS

TOP VIEW

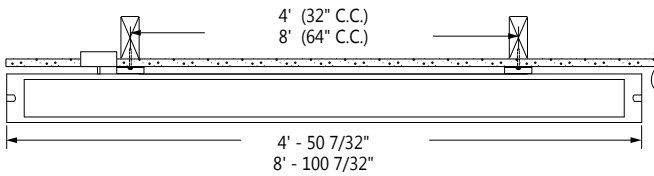

TOP VIEW - END FEED OPTION (EF)

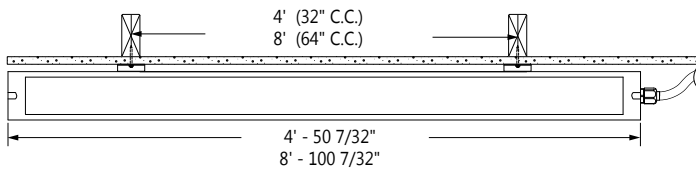

END VIEW

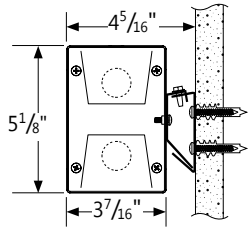

● OTHER MOUNTING OPTIONS

WET BEAM DI is also available with a pendant, mounted options.

● CONSTRUCTION

Housing	Extruded Aluminum (0.062" nominal) Up to 70% Recycled Content
End Cap	Die Cast Zinc (0.070" nominal)
Interior Brackets	Die Formed Sheet Steel (16 ga)
Gaskets	Moulded Elastomer (0.100" nominal)
Lens Gaskets	Extruded Elastomer (0.100" nominal)
Satin Lens	Extruded Acrylic (0.125" nominal) Satin: 67% transmissive
Frosted Lens	Extruded Acrylic (0.125" nominal) Frosted: 85% transmissive
Anti-vandal (AV) Lens	Extruded Polycarbonate (0.125" nominal) Clear: 90% transmissive
Louver	Die formed Semi-Specular Aluminum (22ga) Extruded aluminum (0.060" nominal)
Wall Mounting	Die Formed Sheet Steel (16 ga)

● WEIGHT

4 ft	15 lbs / 6.8 kg
8 ft	30 lbs / 13.6 kg

● GASKETTED FIXTURE

With its gasketed end cap and lens the WET BEAM DI is made for wet locations, it is ideal for exterior soffits and canopies of malls, hospitals and other institutions.

● JOINER SYSTEM

WET BEAM DI modular system consist of smaller modules joined and gasketed together allowing for system runs in lengths of 4', 8' and 12'.

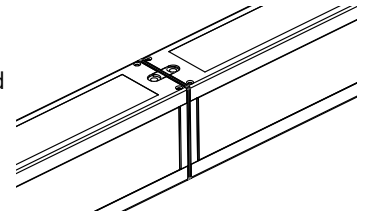

● OPTICS

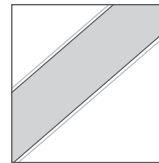

S satin lens

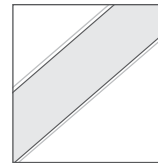

F frosted lens

SATIN & FROSTED LENS

(acrylic snap-in lens)
satin: 68% trans.
frosted: 85% trans.

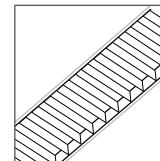

PL semi-specular parabolic louvers

LOUVERS

(semi-spec. parabolic louver)
9/16" deep blades – 5/8" spacing
72 blades per 4'

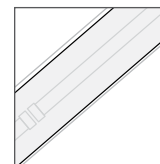

AV clear anti-vandal polycarbonate lens

ANTI-VANDAL LENS

Extruded Polycarbonate
(0.125" nominal)
Clear: 90% trans.

● FINISH

Aluminium paint, Powder Coated and custom finishes are also available.

● ELECTRICAL

Ballast	Electronic IS, Electronic Rapid Start, Dimming (0-10V, Line, EcoSystem, DALI), BI-level dimming With preinstalled ballast disconnect as per NEC & CEC
Emergency	Emergency battery pack or emergency circuit
Voltage	120V, 277V, 347V, UNV

i Incorporating these components may have limitations or effect the length of the luminaire, please contact factory for more details.

● APPROVALS

Certified wet locations to UL and CUL standards Meets ADA requirements

● PHOTOMETRIC DATA

2 T5

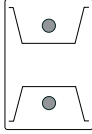

PHOTOMETRIC CURVE

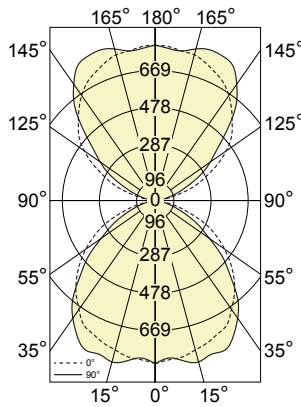

Test Lamp: 2x**F28T5**

IES FILE: WBDI-AV-4-T5-1-1

Efficiency: **79.6%**

CANDELA DISTRIBUTION

Vertical Angle	Horizontal Angles					Zonal Lumens
	0	22.5	45	67.5	90	
0	839	839	839	839	839	
5	822	810	805	833	813	44
15	796	800	817	852	860	196
25	758	772	799	837	849	340
35	684	720	760	757	739	445
45	573	623	617	570	545	470
55	435	480	426	358	340	399
65	283	286	218	197	184	269
75	115	98	77	70	67	122
85	8	10	11	14	13	26
90	1	3	5	5	5	
95	14	15	15	17	16	10
105	125	115	92	82	78	76
115	284	298	230	200	192	207
125	446	492	420	355	346	344
135	560	630	624	556	531	439
145	660	706	755	745	731	462
155	728	748	791	796	820	390
165	776	784	798	809	808	260
175	795	792	788	806	785	112
180	799	799	799	799	799	

COEFFICIENTS OF UTILIZATION (%)

Ceiling	80				70				50			
	70	50	30	10	70	50	30	10	50	30	10	
Wall	70	50	30	10	70	50	30	10	50	30	10	
0	85	85	85	85	79	79	79	79	66	66	66	
1	78	75	72	69	72	69	67	65	59	57	55	
2	71	66	61	57	66	61	57	53	52	49	46	
3	65	58	52	48	60	54	49	45	46	42	39	
4	60	51	45	40	55	48	42	38	41	37	33	
5	55	46	39	35	50	43	37	33	36	32	29	
6	50	41	35	30	46	38	32	28	33	28	25	
7	47	37	31	26	43	34	29	25	30	25	22	
8	43	33	27	23	40	31	26	22	27	23	20	
9	40	31	25	21	37	29	23	20	25	20	17	
10	38	28	22	18	35	26	21	17	23	19	16	

Based on floor reflectance of 20

LUMINANCE DATA (CD/M²)

Vertical Angle	Horizontal Angles		
	0	45	90
45	6599	3687	2784
55	5938	2563	1703
65	4935	1358	932
75	2880	513	356
85	365	83	76

4 T5

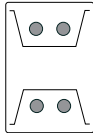

PHOTOMETRIC CURVE

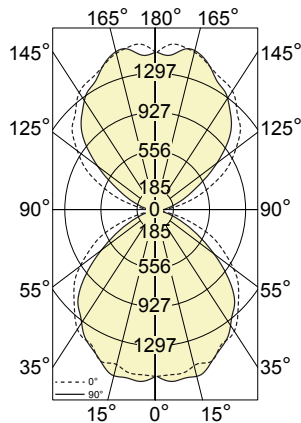

Test Lamp: 4x**F28T5**

IES FILE: WBDI-AV-4-T5-2-2

Efficiency: **72.9%**

CANDELA DISTRIBUTION

Vertical Angle	Horizontal Angles					Zonal Lumens
	0	22.5	45	67.5	90	
0	1612	1612	1612	1612	1612	
5	1601	1545	1549	1668	1668	87
15	1540	1594	1626	1622	1652	382
25	1454	1513	1514	1499	1473	639
35	1348	1366	1340	1299	1267	805
45	1122	1145	1075	1055	1016	849
55	867	847	779	646	609	731
65	579	523	393	317	295	483
75	226	183	129	118	112	215
85	17	17	19	21	23	44
90	1	5	7	8	8	
95	33	23	24	26	27	17
105	263	208	138	133	121	130
115	855	546	401	325	306	361
125	896	862	792	650	611	626
135	1147	1119	1037	1027	989	802
145	1328	1344	1267	1241	1228	823
155	1436	1484	1486	1435	1386	716
165	1567	1536	1556	1557	1583	507
175	1627	1498	1597	1631	1519	224
180	1543	1543	1543	1543	1543	

COEFFICIENTS OF UTILIZATION (%)

Ceiling	80				70				50			
	70	50	30	10	70	50	30	10	50	30	10	
Wall	70	50	30	10	70	50	30	10	50	30	10	
0	78	78	78	78	72	72	72	72	61	61	61	
1	72	69	66	64	66	64	61	59	54	52	51	
2	66	60	56	53	60	56	52	49	48	45	43	
3	60	53	48	44	55	49	45	41	42	39	36	
4	55	47	42	37	51	44	39	35	38	34	31	
5	50	42	36	32	46	39	34	30	34	30	27	
6	46	38	32	28	43	35	30	26	30	26	23	
7	43	34	28	24	40	32	27	23	27	23	20	
8	40	31	25	21	37	29	24	20	25	21	18	
9	37	28	23	19	34	26	21	18	23	19	16	
10	35	26	21	17	32	24	19	16	21	17	15	

Based on floor reflectance of 20

LUMINANCE DATA (CD/M²)

Vertical Angle	Horizontal Angles		
	0	45	90
45	12917	6430	5187
55	11842	4682	3051
65	10088	2452	1495
75	5673	864	594
85	832	139	132

i All IES files for other lamping are available for download at: www.axislighting.com

● PHOTOMETRIC DATA

2 T5

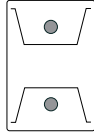

PHOTOMETRIC CURVE

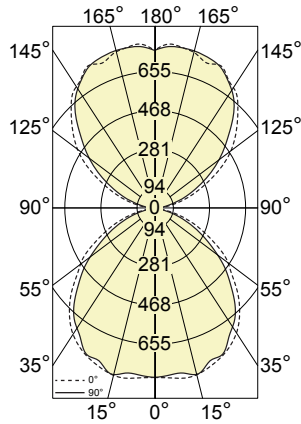

Test Lamp: 2x**F28T5**
IES FILE: WBDI-F-4-T5-1-1

Efficiency: **76.3%**

CANDELA DISTRIBUTION

Vertical Angle	Horizontal Angles					Zonal Lumens
	0	22.5	45	67.5	90	
0	818	818	818	818	818	
5	824	822	818	793	811	44
15	829	803	813	824	828	194
25	784	785	782	788	779	331
35	704	693	690	678	672	419
45	566	570	559	535	520	432
55	423	401	396	362	354	371
65	255	250	231	207	203	261
75	115	104	91	84	82	133
85	17	14	12	12	12	32
90	2	3	3	3	4	
95	26	22	18	16	16	12
105	129	121	107	97	91	88
115	266	259	240	220	213	208
125	434	421	392	369	361	326
135	565	562	549	522	509	405
145	687	682	679	659	664	429
155	761	737	749	753	755	372
165	775	777	776	783	785	255
175	799	799	775	788	786	112
180	765	765	765	765	765	

COEFFICIENTS OF UTILIZATION (%)

Ceiling	80				70				50			
	70	50	30	10	70	50	30	10	50	30	10	
Wall	70	50	30	10	70	50	30	10	50	30	10	
0	82	82	82	82	76	76	76	76	64	64	64	
1	75	72	69	67	69	67	64	62	56	55	53	
2	69	63	59	55	63	58	54	51	50	47	44	
3	63	56	50	46	58	52	47	43	44	40	37	
4	57	49	43	39	53	46	40	36	39	35	32	
5	53	44	38	33	48	41	35	31	35	31	28	
6	48	39	33	29	45	37	31	27	31	27	24	
7	45	35	29	25	41	33	28	24	29	24	21	
8	42	32	26	22	38	30	25	21	26	22	19	
9	39	29	24	20	36	27	22	19	24	20	17	
10	36	27	21	18	33	25	20	17	22	18	15	

Based on floor reflectance of 20

LUMINANCE DATA (CD/M²)

Vertical Angle	Horizontal Angles		
	0	45	90
45	6520	3342	2657
55	5781	2382	1774
65	4440	1441	1031
75	2878	610	434
85	812	90	68

4 T5HO

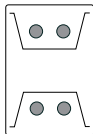

PHOTOMETRIC CURVE

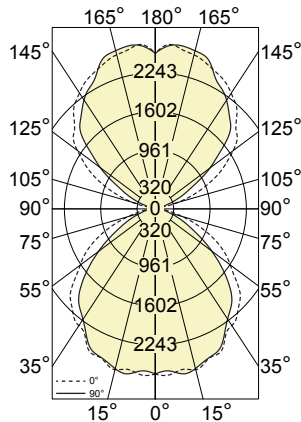

Test Lamp: 4x**F54T5HO**
IES FILE: WBDI-AV-4-T5HO-2-2

Efficiency: **72.9%**

CANDELA DISTRIBUTION

Vertical Angle	Horizontal Angles					Zonal Lumens
	0	22.5	45	67.5	90	
0	2768	2768	2768	2768	2768	
5	2793	2812	2779	2770	2726	149
15	2780	2757	2845	2825	2745	665
25	2630	2658	2631	2528	2578	1112
35	2324	2359	2252	2214	2158	1384
45	2014	1986	1844	1746	1725	1459
55	1493	1450	1340	1132	1059	1255
65	961	896	684	560	524	835
75	370	301	215	205	189	371
85	32	32	33	39	38	77
90	4	9	10	15	13	
95	48	38	43	43	51	30
105	454	352	235	221	207	221
115	1018	935	704	561	523	623
125	1551	1486	1362	1141	1074	1081
135	1910	1939	1839	1761	1765	1393
145	2267	2346	2194	2130	2115	1415
155	2477	2559	2549	2488	2391	1229
165	2634	2700	2718	2754	2704	877
175	2741	2770	2624	2696	2720	386
180	2578	2578	2578	2578	2578	

COEFFICIENTS OF UTILIZATION (%)

Ceiling	80				70				50			
	70	50	30	10	70	50	30	10	50	30	10	
Wall	70	50	30	10	70	50	30	10	50	30	10	
0	78	78	78	78	72	72	72	72	61	61	61	
1	72	69	66	64	66	64	61	59	54	52	51	
2	66	60	56	53	60	56	52	49	48	45	43	
3	60	53	48	44	55	49	45	41	42	39	36	
4	55	47	42	37	51	44	39	35	38	34	31	
5	50	42	36	32	46	39	34	30	34	30	27	
6	46	38	32	28	43	35	30	26	30	26	23	
7	43	34	28	24	40	32	27	23	27	23	20	
8	40	31	25	21	37	29	24	20	25	21	18	
9	37	28	23	19	34	26	22	18	23	19	16	
10	35	26	21	17	32	24	19	16	21	17	15	

Based on floor reflectance of 20

LUMINANCE DATA (CD/M²)

Vertical Angle	Horizontal Angles		
	0	45	90
45	23181	11031	8810
55	20379	8058	5309
65	16748	4268	2660
75	9287	1435	1000
85	1503	248	220

i All IES files for other lamping are available for download at: www.axislighting.com

● PHOTOMETRIC DATA

2 T5HO

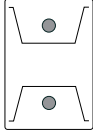

PHOTOMETRIC CURVE

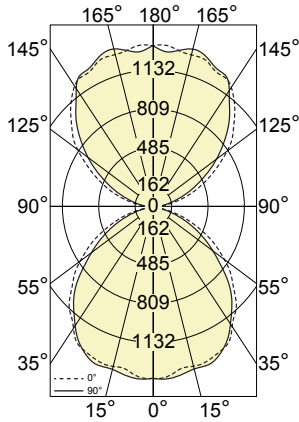

Test Lamp: 2x**F54T5HO**
IES FILE: WBDI-F-4-T5HO-1-1

Efficiency: **76.3%**

CANDELA DISTRIBUTION

Vertical Angle	Horizontal Angles					Zonal Lumens
	0	22.5	45	67.5	90	
0	1447	1447	1447	1447	1447	
5	1437	1409	1447	1430	1456	76
15	1389	1394	1423	1413	1410	334
25	1344	1341	1339	1343	1358	571
35	1179	1190	1213	1163	1151	724
45	965	988	946	919	905	748
55	716	706	669	613	600	637
65	441	427	397	358	350	448
75	195	183	158	146	142	229
85	33	26	22	20	20	55
90	6	4	4	6	6	
95	45	36	33	30	30	21
105	223	211	183	162	161	151
115	464	448	409	377	369	358
125	725	716	677	632	619	561
135	966	968	946	900	882	701
145	1178	1186	1179	1131	1126	736
155	1262	1294	1294	1275	1288	640
165	1328	1344	1354	1385	1380	442
175	1372	1376	1373	1401	1318	194
180	1365	1365	1365	1365	1365	

COEFFICIENTS OF UTILIZATION (%)

Ceiling	80				70				50			
	70	50	30	10	70	50	30	10	50	30	10	
Wall												
0	82	82	82	82	76	76	76	76	64	64	64	
1	75	72	69	66	69	66	64	62	56	55	53	
2	69	63	58	55	63	58	54	51	50	47	44	
3	63	56	50	46	58	51	47	43	44	40	37	
4	57	49	43	39	53	46	40	36	39	35	32	
5	53	44	38	33	48	41	35	31	35	31	28	
6	48	39	33	29	45	37	31	27	31	27	24	
7	45	35	29	25	41	33	28	24	29	24	21	
8	42	32	26	22	38	30	25	21	26	22	19	
9	39	29	24	20	36	27	22	19	24	20	17	
10	36	27	21	18	33	25	20	17	22	18	15	

Based on floor reflectance of 20

LUMINANCE DATA (CD/M²)

Vertical Angle	Horizontal Angles		
	0	45	90
45	11105	5658	4622
55	9773	4024	3011
65	7680	2477	1774
75	4912	1057	751
85	1583	165	115

2 T5HO

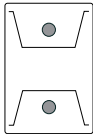

PHOTOMETRIC CURVE

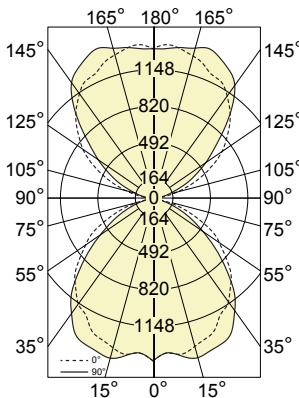

Test Lamp: 2x**F54T5HO**
IES FILE: WBDI-AV-4-T5HO-1-1

Efficiency: **79.6%**

CANDELA DISTRIBUTION

Vertical Angle	Horizontal Angles					Zonal Lumens
	0	22.5	45	67.5	90	
0	1451	1451	1451	1451	1451	
5	1386	1430	1394	1417	1385	75
15	1381	1386	1414	1450	1476	338
25	1301	1359	1406	1427	1437	588
35	1161	1253	1310	1310	1269	765
45	993	1067	1069	997	953	808
55	744	828	731	637	591	691
65	475	500	381	333	318	463
75	187	173	137	122	117	211
85	15	16	21	23	24	44
90	1	5	8	8	8	
95	22	28	25	29	30	18
105	224	200	159	137	134	132
115	495	522	401	352	342	359
125	765	845	730	608	593	590
135	976	1086	1074	981	920	758
145	1147	1217	1270	1286	1270	797
155	1229	1329	1343	1390	1398	671
165	1329	1343	1380	1411	1392	450
175	1381	1324	1297	1372	1345	194
180	1339	1339	1339	1339	1339	

COEFFICIENTS OF UTILIZATION (%)

Ceiling	80				70				50			
	70	50	30	10	70	50	30	10	50	30	10	
Wall												
0	85	85	85	85	79	79	79	79	66	66	66	
1	78	75	72	69	72	69	67	65	59	57	55	
2	72	66	61	57	66	61	57	53	52	49	46	
3	65	58	52	48	60	54	49	45	46	42	39	
4	60	51	45	40	55	48	42	38	41	37	33	
5	55	46	39	35	51	43	37	33	37	32	29	
6	51	41	35	30	47	38	33	28	33	28	25	
7	47	37	31	26	43	34	29	25	30	25	22	
8	43	34	27	23	40	31	26	22	27	23	20	
9	40	31	25	21	37	29	23	20	25	20	17	
10	38	28	22	18	35	26	21	17	23	19	16	

Based on floor reflectance of 20

LUMINANCE DATA (CD/M²)

Vertical Angle	Horizontal Angles		
	0	45	90
45	11425	6396	4865
55	10151	4398	2962
65	8270	2373	1615
75	4709	915	620
85	698	153	139

i All IES files for other lamping are available for download at: www.axislighting.com

● PHOTOMETRIC DATA

2 T8

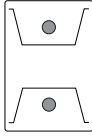

PHOTOMETRIC CURVE

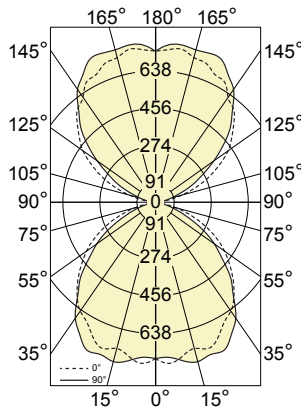

Test Lamp: 2xT8

IES FILE: WBDI-AV-4-T8-1-1

Efficiency: 75.7%

CANDELA DISTRIBUTION

Vertical Angle	Horizontal Angles					Zonal Lumens
	0	22.5	45	67.5	90	
0	771	771	771	771	771	
5	798	761	801	821	768	42
15	746	760	775	805	813	186
25	733	737	771	786	804	325
35	651	675	712	703	692	419
45	543	597	572	541	524	438
55	414	442	403	362	353	380
65	265	270	219	196	182	261
75	110	98	78	65	65	118
85	9	9	11	13	12	24
90	1	3	3	4	5	
95	14	13	14	15	15	9
105	125	110	84	74	73	72
115	284	282	223	205	194	201
125	435	455	406	358	345	331
135	547	582	568	530	522	417
145	627	677	700	676	674	432
155	696	725	752	762	776	370
165	739	739	761	775	779	252
175	758	770	785	762	782	110
180	747	747	747	747	747	

COEFFICIENTS OF UTILIZATION (%)

Ceiling	80				70				50			
	70	50	30	10	70	50	30	10	50	30	10	
Wall	70	50	30	10	70	50	30	10	50	30	10	
0	81	81	81	81	75	75	75	75	63	63	63	
1	75	71	69	66	69	66	64	61	56	54	53	
2	68	63	58	54	63	58	54	51	49	46	44	
3	62	55	50	45	57	51	46	43	44	40	37	
4	57	49	43	38	52	45	40	36	39	35	32	
5	52	44	37	33	48	40	35	31	35	31	27	
6	48	39	33	29	44	36	31	27	31	27	24	
7	44	35	29	25	41	33	27	24	28	24	21	
8	41	32	26	22	38	30	25	21	26	22	19	
9	38	29	23	20	35	27	22	19	24	19	17	
10	36	27	21	18	33	25	20	17	22	18	15	

Based on floor reflectance of 20

LUMINANCE DATA (CD/M²)

Vertical Angle	Horizontal Angles		
	0	45	90
45	6253	3423	2678
55	5656	2425	1768
65	4618	1363	922
75	2771	519	342
85	438	81	69

2 T8

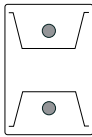

PHOTOMETRIC CURVE

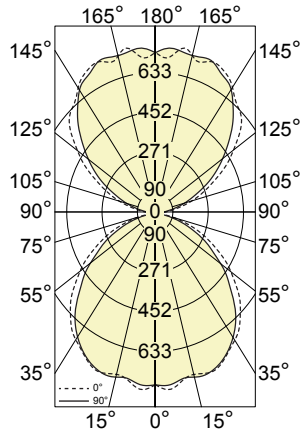

Test Lamp: 2xT8

IES FILE: WBDI-F-4-T8-1-1

Efficiency: 72.5%

CANDELA DISTRIBUTION

Vertical Angle	Horizontal Angles					Zonal Lumens
	0	22.5	45	67.5	90	
0	791	791	791	791	791	
5	814	802	764	799	793	42
15	766	762	783	774	780	184
25	745	738	744	739	740	314
35	665	656	647	632	639	395
45	546	541	524	499	487	410
55	400	384	368	344	334	350
65	249	238	216	201	198	248
75	108	102	90	82	78	127
85	15	14	11	12	10	30
90	3	2	3	4	3	
95	25	21	18	15	15	12
105	123	112	101	91	90	84
115	254	250	227	212	203	199
125	405	389	371	348	342	309
135	556	530	519	494	480	385
145	639	646	635	622	621	405
155	732	725	715	706	713	353
165	728	749	744	735	748	244
175	722	744	765	771	765	108
180	741	741	741	741	741	

COEFFICIENTS OF UTILIZATION (%)

Ceiling	80				70				50			
	70	50	30	10	70	50	30	10	50	30	10	
Wall	70	50	30	10	70	50	30	10	50	30	10	
0	78	78	78	78	72	72	72	72	60	60	60	
1	71	68	65	63	66	63	61	59	53	52	50	
2	65	60	55	52	60	55	52	48	47	44	42	
3	59	53	47	43	55	49	44	41	42	38	35	
4	54	47	41	37	50	43	38	35	37	33	30	
5	50	42	36	31	46	39	34	30	33	29	26	
6	46	37	31	27	42	35	30	26	30	26	23	
7	42	34	28	24	39	31	26	23	27	23	20	
8	39	31	25	21	36	28	23	20	25	21	18	
9	37	28	22	19	34	26	21	18	23	19	16	
10	34	26	20	17	32	24	19	16	21	17	14	

Based on floor reflectance of 20

LUMINANCE DATA (CD/M²)

Vertical Angle	Horizontal Angles		
	0	45	90
45	6289	3135	2486
55	5466	2213	1673
65	4335	1349	1006
75	2710	599	416
85	735	80	60

i All IES files for other lamping are available for download at: www.axislighting.com

● PHOTOMETRIC DATA

2 T8

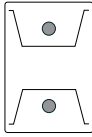

PHOTOMETRIC CURVE

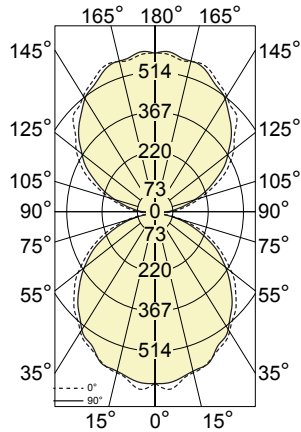

Test Lamp: 2xF32T8
IES FILE: WBDI-S-4-T8-1-1

Efficiency: 60.8%

CANDELA DISTRIBUTION

Vertical Angle	Horizontal Angles					Zonal Lumens
	0	22.5	45	67.5	90	
0	637	637	637	637	637	
5	660	629	637	621	635	34
15	610	596	596	610	604	145
25	560	563	562	552	549	239
35	498	503	499	498	485	302
45	425	422	405	410	400	321
55	332	328	317	312	307	298
65	231	224	219	208	203	235
75	122	120	111	103	103	143
85	32	25	18	15	13	45
90	5	3	3	3	4	
95	40	36	28	23	21	18
105	137	132	122	118	111	105
115	240	230	223	214	216	201
125	343	331	316	313	317	276
135	418	416	400	404	401	312
145	491	494	480	482	473	310
155	547	552	535	529	532	266
165	588	582	582	577	585	188
175	597	609	598	636	608	86
180	601	601	601	601	601	

COEFFICIENTS OF UTILIZATION (%)

Ceiling	80				70				50			
	70	50	30	10	70	50	30	10	50	30	10	
Wall	70	50	30	10	70	50	30	10	50	30	10	
0	65	65	65	65	60	60	60	60	51	51	51	
1	60	57	55	52	55	53	51	49	45	43	42	
2	54	50	46	43	50	46	43	40	39	37	34	
3	49	44	39	36	45	40	36	33	34	31	29	
4	45	39	34	30	41	36	31	28	30	27	25	
5	41	34	29	26	38	32	27	24	27	24	21	
6	38	31	26	22	35	29	24	21	24	21	18	
7	35	28	23	19	32	26	21	18	22	19	16	
8	33	25	20	17	30	23	19	16	20	17	14	
9	30	23	18	15	28	21	17	14	18	15	13	
10	28	21	16	14	26	20	16	13	17	14	11	

Based on floor reflectance of 20

LUMINANCE DATA (CD/M²)

Vertical Angle	Horizontal Angles		
	0	45	90
45	4895	2421	2043
55	4531	1905	1541
65	4019	1365	1030
75	3055	744	545
85	1541	131	76

i All IES files for other lamping are available for download at: www.axislighting.com