



Project _____

Type _____

Notes _____

PERFORMANCE AT 4000K

NOMINAL LUMEN OUTPUT	INPUT WATTS*	EFFICACY
4000 lm	41.16W	97 lm/W
5000 lm	53.46W	94 lm/W
6500 lm	70.65W	92 lm/W
7700 lm	85.33W	90 lm/W

Please consult factory for custom lumen output and wattage.

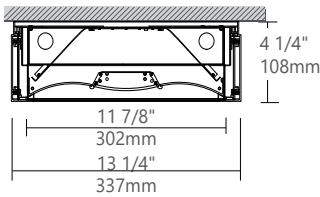

SECTION VIEW

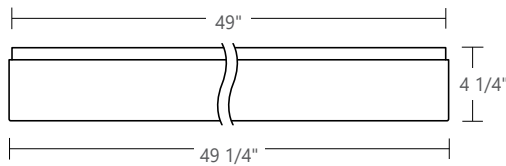

SIDE VIEW



Ordering Guide

WALED		SIZE		NOMINAL LUMENS		CRI		COLOR TEMP.		SHIELDING		FINISH	
PRODUCT ID	Wave LED	14	1'X4'	4000	4000 lm - Minimum	80	80 CRI	27	2700 K	VL	VL optics	W	white
				7700	7700 lm - Maximum	90	90 CRI	30	3000 K			BLK	black
								35	3500 K			C	custom
								40	4000 K				

Outputs between listed min and max are available. Consult factory for outputs outside of the listed range.

VOLTAGE		DRIVER		CIRCUITS		MOUNTING/SUSPENSION		BATTERY (OPTIONAL)	
120	120 V	DP	dimming (0-10V) 1%	1	1 circuit	SM	surface mount	B#	Battery Pack
277	277 V	LT	Lutron ⁽¹⁾	+E(#)	emergency circuit ⁽³⁾				
347	347 V	BI	bi-level dimming	+NL(#)	night light circuit ⁽³⁾				
UNV	universal	O	other ⁽²⁾	+GTD(#)	generator transfer device ⁽³⁾				

(1) Specify system
(2) Please consult factory
(3) Specify quantity

Not available with 347V Please consult factory

OTHER (OPTIONAL)	IC CONTROLS (OPTIONAL)	CUSTOM (OPTIONAL)
F fuse ⁽⁴⁾	DS# daylight sensor	C custom
FW(#) flex whip (6' std)	OS# occupancy sensor	
	DOS# daylight & occupancy sensor	
	EN# Enlighted integral ⁽⁵⁾	
	ENR# Enlighted remote ⁽⁵⁾	
	WC# wireless control dimming	

(4) Requires 120V or 277V
(5) Please consult factory Specify quantity. Requires 1.5" blank. See integrated controls guide for more details.

Please specify

SPECIFY DRIVER NAME (if needed)

SPECIFY BATTERY NAME (if needed)

● **SPECIFICATIONS**

Housing	Die formed cold rolled sheet steel (20 gauge)
Central Lens Housing	Extruded aluminum (0.060" nominal)
Center Lens	PMMA Precision formed microconical structure 92 percent transmission, cuts off glare above 55°.
Side lens	0.08" PMMA satin blend
Reflectors	Die formed cold rolled sheet steel (22 gauge)
Interior Brackets	Die formed cold rolled sheet steel (20 gauge)
Surface Mount Kit	Extruded aluminum (0.070" nominal)

● **ELECTRICAL**

Lutron driver* LDE1 - EcoSystem H-Series (1%)
LDE5 - EcoSystem 5-Series (5%)
LTE - Hi-Lume® A-series 2Wires Forward Phase (1%)
*Consult factory

Other drivers DALI - Digital Addressable Lighting Interface
DMX - Digital Multiplex
LV - line voltage - Advance Mark 10
Xitanium SR - For wireless sensor

Emergency Integral emergency battery pack or emergency circuit optional.

Input Voltage 120V, 277V, 347V, UNV.

i Incorporating these components may have limitations or affect the length of the luminaire. Please contact factory for more details.

● **FINISH**

Highly reflective, matte powder coat white paint for high efficiency. Matte texture to diffuse glare and lamp image on the surface within the optical chamber exterior. Custom finishes are also available.

● **WARRANTY**

Axis Lighting will warrant defective LEDs, boards, and drivers for 5 years from date of purchase. Warranty is valid if luminaire is installed and used according to specifications. If defective, Axis will send replacement boards or drivers at no cost along with detailed replacement instructions and instructions on how to return defective components to Axis.

● **APPROVALS**

Certified to UL and CSA standards 
Meets NYC requirements
Suitable for damp locations.

● **WEIGHT**

Surface Mount 26 lbs / 11.8 kg

● **CEILING SYSTEM**

MOUNTING HOLES POSITION

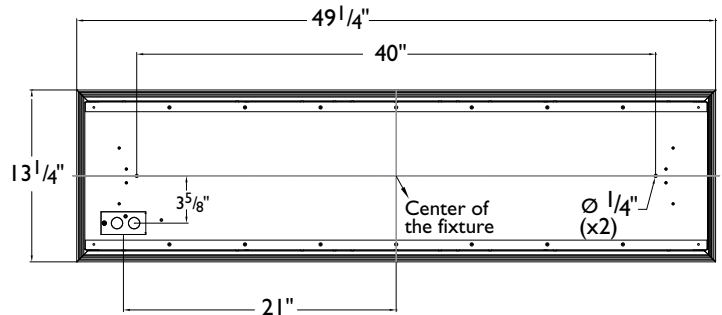

RECESSED OPTION

For more details see recessed specification sheets available at: www.axislighting.com

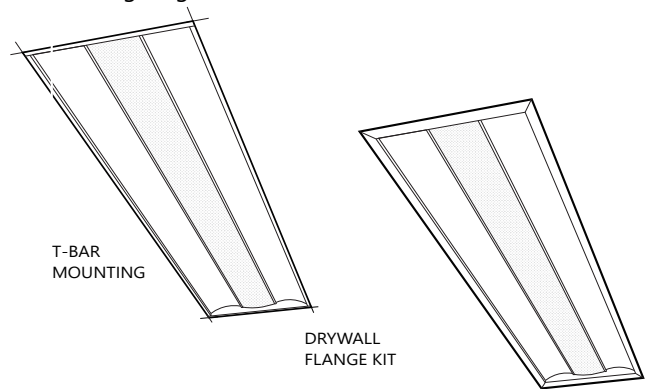

i Installation sheets for all mountings options are available at: www.axislighting.com

● **STANDARD AND END MOUNT POWER FEED**

Knockouts for BX cable connection are provided both on the top and on the ends of the luminaire. This allows for an end mount power feed solution if it is required.

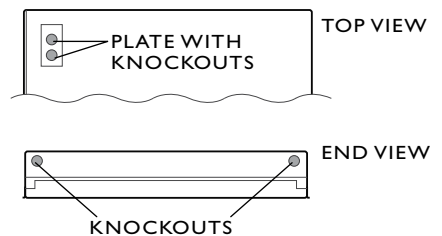

● **PHOTOMETRIC DATA**

LED

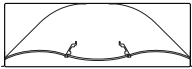

PHOTOMETRIC CURVE

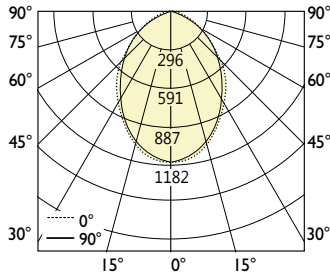

Luminaire Lumens: 2400 lm
Input Watts: 22.765 W
Efficacy: 103 lm/W
 IES FILE: WALED-14-2400-80-40-VL.ies

TESTED ACCORDING TO IES LM-79-2008

CANDELA DISTRIBUTION

Vertical Angle	Horizontal Angles					Zonal Lumens
	0	20	40	70	90	
0	1176	1176	1176	1176	1176	
10	1130	1124	1116	1107	1104	53
20	993	979	967	952	938	92
30	803	805	804	791	794	111
40	636	639	651	657	649	116
50	407	415	423	415	419	90
60	250	265	266	258	259	64
70	154	165	158	128	126	40
80	72	74	58	55	53	17
90	0	0	0	0	0	

COEFFICIENTS OF UTILIZATION (%)

Ceiling	80			70			50				
	70	50	30	10	70	50	30	10	50	30	10
Wall											
0	118	118	118	118	116	116	116	116	110	110	110
1	109	105	101	96	107	103	99	95	99	96	92
2	100	93	87	79	98	91	86	79	88	83	77
3	92	83	75	67	90	81	74	67	78	73	66
4	85	74	66	58	83	73	66	57	71	64	57
5	79	67	59	50	77	66	58	50	64	57	50
6	73	61	53	44	72	60	52	44	58	51	44
7	68	56	48	40	67	55	47	40	54	47	40
8	64	51	43	36	63	51	43	36	49	43	36
9	60	47	40	33	59	47	39	32	46	39	32
10	56	44	37	30	55	44	36	30	43	36	30

Based on floor reflectance of 20

LED

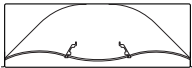

PHOTOMETRIC CURVE

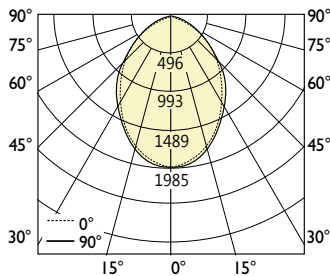

Luminaire Lumens: 4000 lm
Input Watts: 41.16 W
Efficacy: 97 lm/W
 IES FILE: WALED-14-4000-80-40-VL.ies

TESTED ACCORDING TO IES LM-79-2008

CANDELA DISTRIBUTION

Vertical Angle	Horizontal Angles					Zonal Lumens
	0	22.5	45	67.5	90	
0	1983	1983	1983	1983	1983	
10	1909	1911	1905	1906	1907	91
20	1693	1691	1677	1669	1665	157
30	1388	1398	1401	1398	1399	192
40	1110	1124	1145	1140	1127	199
50	693	719	719	705	713	149
60	444	463	455	444	447	107
70	268	278	269	237	230	67
80	126	120	95	86	85	27
90	0	0	0	0	0	

COEFFICIENTS OF UTILIZATION (%)

Ceiling	80			70			50				
	70	50	30	10	70	50	30	10	50	30	10
Wall											
0	120	120	120	120	117	117	117	117	112	112	112
1	111	106	102	97	108	104	101	96	100	97	93
2	102	94	88	81	99	92	87	80	89	84	78
3	94	84	77	68	91	82	76	68	80	74	67
4	86	75	67	59	84	74	67	58	72	65	58
5	80	68	60	51	78	67	59	51	65	58	51
6	74	62	53	45	72	61	53	45	59	52	45
7	69	57	48	40	68	56	48	40	54	47	40
8	65	52	44	36	63	51	44	36	50	43	36
9	61	48	40	33	59	47	40	33	46	39	33
10	57	44	37	30	56	44	37	30	43	36	30

Based on floor reflectance of 20

LUMINANCE DATA (cd/m²)

Vertical Angle	Horizontal Angles		
	0	45	90
45	3501	3587	3559
55	2569	2692	2616
65	2220	2281	2162
75	2011	1813	1529
85	1682	1121	1065

i All IES files are available for download at: www.axislighting.com

● **PHOTOMETRIC DATA**

LED

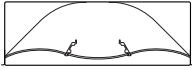

PHOTOMETRIC CURVE

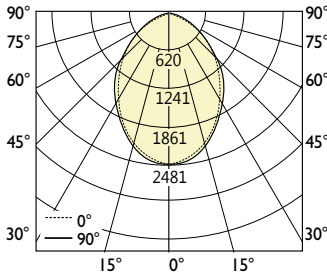

Luminaire Lumens: 5000 lm
Input Watts: 53.46W
Efficacy: 94 lm/W
 IES FILE: WALED-14-5000-80-40-VL.ies
 TESTED ACCORDING TO IES LM-79-2008

CANDELA DISTRIBUTION

Vertical Angle	Horizontal Angles					Zonal Lumens
	0	22.5	45	67.5	90	
0	2479	2479	2479	2479	2479	
10	2386	2389	2381	2382	2384	114
20	2117	2113	2096	2086	2081	197
30	1735	1747	1751	1747	1748	239
40	1387	1405	1431	1425	1409	249
50	867	899	899	882	891	187
60	556	578	569	556	559	134
70	335	348	336	297	287	83
80	158	150	118	108	106	34
90	0	0	0	0	0	

LUMINANCE DATA (cd/m²)

Vertical Angle	Horizontal Angles		
	0	45	90
45	4376	4484	4449
55	3211	3365	3270
65	2775	2840	2703
75	2514	2266	1912
85	2103	1402	1332

COEFFICIENTS OF UTILIZATION (%)

Ceiling	80				70				50			
	70	50	30	10	70	50	30	10	70	50	30	10
Wall	70	50	30	10	70	50	30	10	70	50	30	10
0	120	120	120	120	117	117	117	117	112	112	112	112
1	111	106	102	97	108	104	101	96	100	97	93	93
2	102	94	88	81	99	92	87	80	89	84	78	78
3	94	84	77	68	91	82	76	68	80	74	67	67
4	86	75	67	59	84	74	67	58	72	65	58	58
5	80	68	60	51	78	67	59	51	65	58	51	51
6	74	62	53	45	72	61	53	45	59	52	45	45
7	69	57	48	40	68	56	48	40	54	47	40	40
8	65	52	44	36	63	51	44	36	50	43	36	36
9	61	48	40	33	59	47	40	33	46	39	33	33
10	57	44	37	30	56	44	37	30	43	36	30	30

Based on floor reflectance of 20

LED



PHOTOMETRIC CURVE

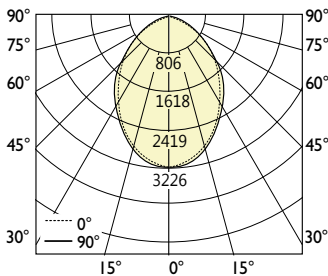

Luminaire Lumens: 6500 lm
Input Watts: 70.65W
Efficacy: 92 lm/W
 IES FILE: WALED-14-6500-80-40-VL.ies
 TESTED ACCORDING TO IES LM-79-2008

CANDELA DISTRIBUTION

Vertical Angle	Horizontal Angles					Zonal Lumens
	0	22.5	45	67.5	90	
0	3223	3223	3223	3223	3223	
10	3102	3106	3096	3097	3099	148
20	2752	2747	2725	2712	2706	256
30	2255	2272	2276	2272	2273	311
40	1803	1827	1861	1852	1831	324
50	1127	1168	1168	1146	1158	243
60	722	752	740	722	727	174
70	436	452	437	385	374	108
80	205	195	154	140	137	45
90	0	0	0	0	0	

LUMINANCE DATA (cd/m²)

Vertical Angle	Horizontal Angles		
	0	45	90
45	5688	5829	5764
55	4174	4375	4251
65	3608	3692	3514
75	3268	2946	2485
85	2734	1822	1731

COEFFICIENTS OF UTILIZATION (%)

Ceiling	80				70				50			
	70	50	30	10	70	50	30	10	70	50	30	10
Wall	70	50	30	10	70	50	30	10	70	50	30	10
0	120	120	120	120	117	117	117	117	112	112	112	112
1	111	106	102	97	108	104	101	96	100	97	93	93
2	102	94	88	81	99	92	87	80	89	84	78	78
3	94	84	77	68	91	82	76	68	80	74	67	67
4	86	75	67	59	84	74	67	58	72	65	58	58
5	80	68	60	51	78	67	59	51	65	58	51	51
6	74	62	53	45	72	61	53	45	59	52	45	45
7	69	57	48	40	68	56	48	40	54	47	40	40
8	65	52	44	36	63	51	44	36	50	43	36	36
9	61	48	40	33	59	47	40	33	46	39	33	33
10	57	44	37	30	56	44	37	30	43	36	30	30

Based on floor reflectance of 20

i All IES files are available for download at: www.axislighting.com

● **PHOTOMETRIC DATA**

LED

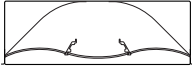

PHOTOMETRIC CURVE

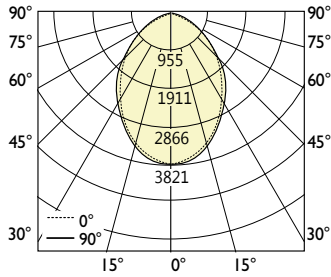

Luminaire Lumens: 7700 lm
Input Watts: 85.33 W
Efficacy: 90 lm/W
 IES FILE: WALED-14-7700-80-40-VL.ies
 TESTED ACCORDING TO IES LM-79-2008

CANDELA DISTRIBUTION

Vertical Angle	Horizontal Angles					Zonal Lumens
	0	22.5	45	67.5	90	
0	3818	3818	3818	3818	3818	
10	3674	3679	3667	3669	3671	175
20	3260	3254	3228	3212	3205	303
30	2672	2691	2696	2691	2693	369
40	2136	2164	2205	2194	2170	384
50	1335	1384	1384	1358	1372	288
60	856	891	877	856	861	207
70	516	535	518	457	443	128
80	243	231	182	166	163	53
90	0	0	0	0	0	

LUMINANCE DATA (cd/m²)

Vertical Angle	Horizontal Angles		
	0	45	90
45	6739	6905	6852
55	4945	5183	5035
65	4274	4374	4163
75	3871	3489	2944
85	3238	2159	2051

COEFFICIENTS OF UTILIZATION (%)

Ceiling	COEFFICIENTS OF UTILIZATION (%)											
	80				70				50			
Wall	70	50	30	10	70	50	30	10	50	30	10	
0	120	120	120	120	117	117	117	117	112	112	112	
1	111	106	102	97	108	104	101	96	100	97	93	
2	102	94	88	81	99	92	87	80	89	84	78	
3	94	84	77	68	91	82	76	68	80	74	67	
4	86	75	67	59	84	74	67	58	72	65	58	
5	80	68	60	51	78	67	59	51	65	58	51	
6	74	62	53	45	72	61	53	45	59	52	45	
7	69	57	48	40	68	56	48	40	54	47	40	
8	65	52	44	36	63	51	44	36	50	43	36	
9	61	48	40	33	59	47	40	33	46	39	33	
10	57	44	37	30	56	44	37	30	43	36	30	

Based on floor reflectance of 20

i All IES files are available for download at: www.axislighting.com