

● **PROJECT INFORMATION**

Project:

Type:

Notes:

Approved by: Date:

● **DIMENSIONS**

SECTION VIEW

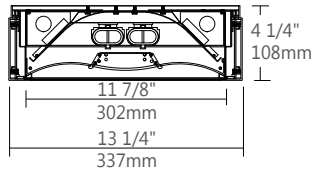

SIDE VIEW

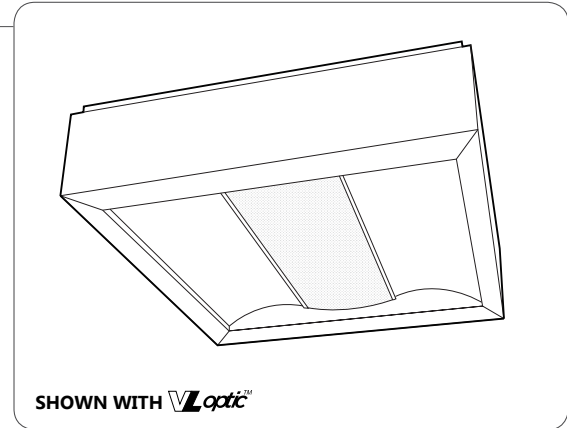
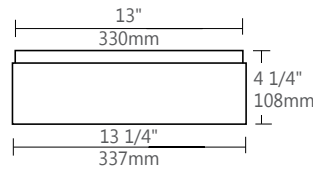

● **ORDERING CODE**

1	2	3	4	5	6	7	8	9	10	11	12	13	14
---	---	---	---	---	---	---	---	---	----	----	----	----	----

● **PRODUCT SPECIFICATIONS**

1 PRODUCT ID	2 SIZE	3 CENTER OPTIC	4 LAMP	5 LAMP CONFIGURATION	6 FINISH
WA wave	11 1'X1'	VL vl optic	F18TT TT18W (2G11) CFTR18 CFTR18 CFTR26 CFTR26	1 1 lamp ⁽¹⁾ 2 2 lamps	W white BLK black C custom

(1) Not available for CFTR18 & 26

7 VOLTAGE	8 BALLAST	9 CIRCUITS	10 MOUNTING/SUSPENSION	11 BATTERY (OPTIONAL)
120 120V 277 277V 347 347V ⁽²⁾ UNV universal	D dimming E instant start ⁽³⁾ ERS program start BI bi-level dimming +M master +S satellite	1 1 regular 2 2 regular 2A/B 2 alternating +E(#) emergency section +NL(#) night light section +GTD(#) generator transfer device	SM surface mount	B# remote battery pack only

(2) Please consult factory (3) Available with T8 lamp only

12 OTHER (OPTIONAL)	13 IC CONTROLS (OPTIONAL)	14 CUSTOM (OPTIONAL)
F fuse FW(#) flex whip (6' std)	DS# daylight sensor OS# occupancy sensor DS+OS# daylight+occupancy sensor DOS# daylight&occupancy sensor See integrated controls guide for further details	C custom Please specify

SPECIFY BALLAST NAME (if needed)

SPECIFY BATTERY NAME (if needed)

● **CEILING SYSTEM**

SURFACE HOLES POSITION

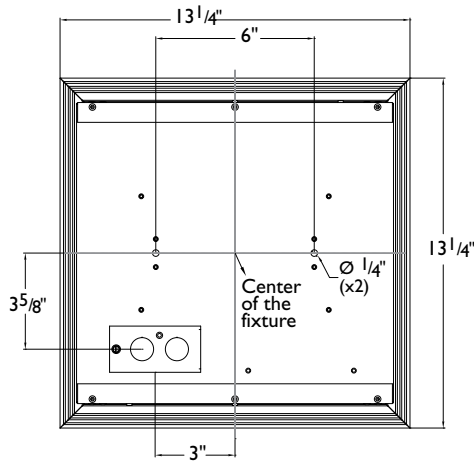

RECESSED OPTION

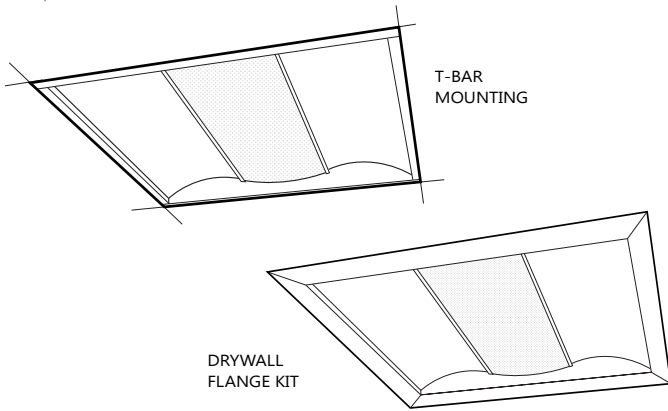

i Installation sheets for all mounting options are available at: www.axislighting.com

● **CONSTRUCTION**

Housing	Die formed cold rolled sheet steel (20 gauge)
Central Lens Housing Reflectors	Extruded aluminum (0.060" nominal) Die formed cold rolled sheet steel (22 gauge)
Interior Brackets	Die formed cold rolled sheet steel (20 gauge)
Surface Mount Kit	Extruded aluminum (0.070" nominal)

● **WEIGHT**

Surface mount	11 lbs / 5.0 kg
----------------------	-----------------

● **OPTICAL SYSTEM**

WAVE optical system includes two side lenses and one center lens. Center lens has an extruded aluminum frame and can be opened to replace the lamps. Side lenses are 0.08" PMMA satin blend.

There are three available options for center lens:

- VL^{opti}™**: PMMA Precision formed microconical structure (VL Optic) 92 percent transmissive that cuts off glare above 55 degrees.
- Satin**: PMMA blend satin lens (0.12" nominal) 68% transmissive.
- MICRO SLOTS**: The Micro Slots (MS) diffuser consists of a steel micro-slotted grid backed with a translucent frosted acrylic overlay.

● **FINISH**

Highly reflective, matte powder coat white paint for high efficiency. Matte texture to diffuse glare and lamp image on the surface within the optical chamber exterior. Custom finishes are also available.

● **ELECTRICAL**

- Ballast** Electronic IS, Electronic Rapid Start, Dimming (0-10V, Line, EcoSystem, DALI), BI-level dimming
With preinstalled ballast disconnect as per NEC & CEC
- Emergency** Emergency battery pack or emergency circuit
- Voltage** 120V, 277V, 347V, UNV

● **STANDARD AND END MOUNT POWER FEED**

Knockouts for BX cable connection are provided both on the top and on the ends of the luminaire. This allows for an end mount power feed solution if it is required.



(BX CABLE BY OTHER)

● **MASTER / SATELLITE CONFIGURATION**

Master / Satellite configuration allows the satellite luminaire to share a ballast and power supply with the master luminaire.

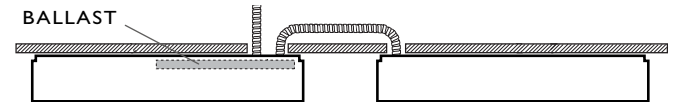

i Check Master/Satellite Installation Guide file DIA-PO-WA.MS.INST for details.

● **APPROVALS**

Certified to UL and CUL standards 
 Suitable for damp locations.

● **INTEGRATED CONTROL OPTIONS**

WAVE luminaires allow the use of integrated controls such as daylight sensors (DS), occupancy sensors (OS), individual daylight sensors and occupancy sensors (DS+OS), and combination daylight/occupancy sensors (DOS). These options can be seamlessly integrated into our luminaires. The control system could be used to optimize the lighting of the space by reducing energy consumption through daylight harvesting and occupancy, thereby improving the overall interior environment and allowing for LEED credits.

- Consult factory for other options.
- Refer to IC brochure for more information.

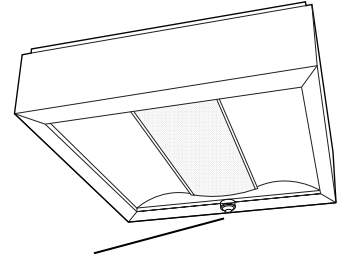

SENSORS	BRAND	Model	TYPE	CODE	COMPATIBLE DIMMING BALLAST
Daylight Sensor (DS)	Wattstopper	FD-301	Daylight	WD	0-10V
Occupancy Sensor (OS)	Wattstopper	FS-205	PIR Occupancy	WP1	Programmed Rapid Start
		FS-355	PIR Occupancy	WP2	Programmed Rapid Start
		FS-155	PIR Occupancy	WP3	Programmed Rapid Start
		FS-505	Ultrasonic Occupancy	WU1	Programmed Rapid Start
		FS-505C	Ultrasonic Occupancy	WU2	Programmed Rapid Start
		FM-105	High Frequency Occupancy	WH	Programmed Rapid Start
Daylight & Occupancy Sensors (DOS)	Philips	Actilume	Daylight & PIR Occupancy	PA	DALI or 0-10V

● **PHOTOMETRIC DATA**

2 CFTR 18W

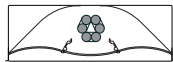

with **V-logic**

PHOTOMETRIC CURVE

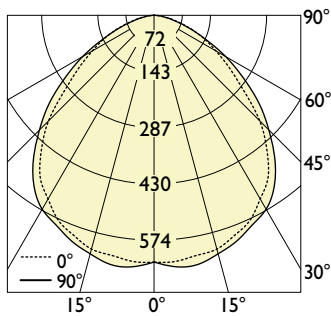

Test Lamp: 2xCTFR 18W
 IES FILE: WAI1-VL-CTFR18W-2

Efficiency: 75.7%

CANDELA DISTRIBUTION

Vertical Angle	Horizontal Angles					Zonal Lumens
	0	22.5	45	67.5	90	
0	707	707	707	707	707	
5	708	707	713	724	724	38
15	694	691	698	703	708	166
25	649	657	664	665	664	281
35	569	576	591	596	600	357
45	428	449	472	469	465	365
55	264	281	313	314	311	294
65	157	162	176	171	163	191
75	69	72	76	65	62	95
85	15	16	17	15	13	29
90	2	2	2	2	2	

COEFFICIENTS OF UTILIZATION (%)

Ceiling	80			70			50				
	70	50	30	10	70	50	30	10	50	30	10
Wall											
0	90	90	90	90	88	88	88	88	84	84	84
1	83	80	77	75	81	78	76	73	75	73	71
2	77	71	66	62	75	69	65	61	67	63	60
3	70	63	57	53	68	62	56	52	59	55	51
4	65	56	50	45	63	55	49	45	53	48	44
5	60	50	44	39	58	50	44	39	48	43	39
6	55	46	39	34	54	45	39	34	44	38	34
7	51	41	35	31	50	41	35	30	40	34	30
8	48	38	32	27	47	37	31	27	36	31	27
9	45	35	29	25	44	34	29	25	34	28	25
10	42	32	26	22	41	32	26	22	31	26	22

Based on floor reflectance of 20

LUMINANCE DATA (CD/M²)

Vertical Angle	Horizontal Angles		
	0	45	90
45	5046	4994	5423
55	3454	3580	4018
65	2401	2255	2440
75	1309	1159	1141
85	380	325	330

i All IES files are available for download at www.axislighting.com

PHOTOMETRIC DATA

2 CFTR 26W

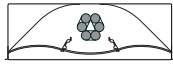

with **VLoptic™**

PHOTOMETRIC CURVE

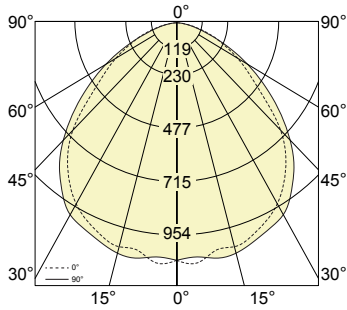

Test Lamp: 2xCTFR 26W
 IES FILE: WAI1-VL-CFTR26W-2

Efficiency: 75.5%

CANDELA DISTRIBUTION

Vertical Angle	Horizontal Angles					Zonal Lumens
	0	22.5	45	67.5	90	
0	1058	1058	1058	1058	1058	
5	1073	1064	1065	1069	1047	57
15	1030	1042	1053	1051	1057	249
25	963	969	992	997	1002	421
35	839	853	880	898	895	533
45	641	668	704	704	705	545
55	392	423	468	471	469	439
65	231	240	261	255	250	286
75	106	110	116	98	93	144
85	22	25	25	23	21	44
90	2	3	2	3	2	

LUMINANCE DATA (CD/M²)

Vertical Angle	Horizontal Angles		
	0	45	90
45	7550	7454	8218
55	5132	5346	6064
65	3524	3351	3755
75	2007	1759	1727
85	576	480	520

COEFFICIENTS OF UTILIZATION (%)

Ceiling	80				70				50			
	70	50	30	10	70	50	30	10	50	30	10	
Wall												
0	90	90	90	90	88	88	88	88	84	84	84	84
1	83	80	77	73	81	78	76	72	75	73	70	70
2	76	71	66	60	74	69	65	60	67	63	58	58
3	70	63	57	50	68	61	56	50	59	55	49	49
4	64	56	50	43	63	55	49	43	53	48	42	42
5	59	50	44	37	58	49	43	37	48	42	37	37
6	55	45	39	32	54	45	39	32	43	38	32	32
7	51	41	35	29	50	41	35	29	40	34	29	29
8	48	38	32	26	46	37	31	26	36	31	25	25
9	45	35	29	23	43	34	28	23	33	28	23	23
10	42	32	26	21	41	32	26	21	31	26	21	21

Based on floor reflectance of 20

1 F18TT

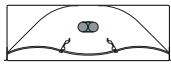

with **VLoptic™**

PHOTOMETRIC CURVE

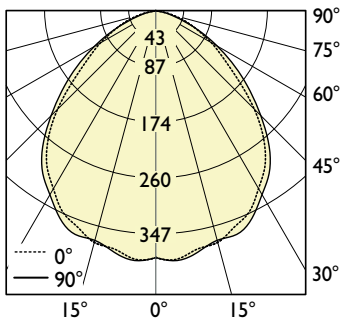

Test Lamp: 1xF18TT
 IES FILE: WAI1-VL-F18TT-1

Efficiency: 78.1%

CANDELA DISTRIBUTION

Vertical Angle	Horizontal Angles					Zonal Lumens
	0	22.5	45	67.5	90	
0	384	384	384	384	384	
5	388	382	384	382	390	21
15	374	372	375	369	370	89
25	346	348	352	357	356	150
35	297	302	309	309	309	187
45	220	232	238	235	233	187
55	131	143	156	154	152	146
65	76	82	87	83	80	95
75	35	38	38	32	29	47
85	8	8	9	7	7	15
90	1	1	1	1	1	

LUMINANCE DATA (CD/M²)

Vertical Angle	Horizontal Angles		
	0	45	90
45	2588	2519	2723
55	1713	1778	1968
65	1154	1113	1204
75	656	581	531
85	199	173	179

COEFFICIENTS OF UTILIZATION (%)

Ceiling	80				70				50			
	70	50	30	10	70	50	30	10	50	30	10	
Wall												
0	93	93	93	93	91	91	91	91	87	87	87	87
1	86	83	80	77	84	81	78	76	78	76	74	74
2	79	73	68	64	77	72	67	64	69	65	62	62
3	73	65	59	55	71	64	58	54	62	57	53	53
4	67	58	52	47	65	57	51	47	55	50	46	46
5	62	52	46	41	60	51	45	41	50	44	40	40
6	57	47	41	36	56	47	40	36	45	40	36	36
7	53	43	37	32	52	43	36	32	41	36	32	32
8	50	39	33	29	48	39	33	29	38	32	29	29
9	46	36	30	26	45	36	30	26	35	30	26	26
10	44	34	28	24	43	33	27	24	32	27	23	23

Based on floor reflectance of 20

i All IES files are available for download at: www.axislighting.com

PHOTOMETRIC DATA

2 F18TT

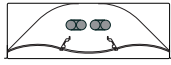

with **VLoptic™**

PHOTOMETRIC CURVE

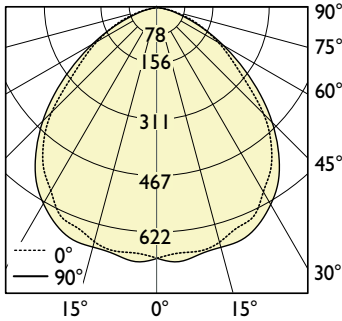

Test Lamp: 2x F18TT
 IES FILE: WA11-VL-F18TT-2

Efficiency: 72.7%

CANDELA DISTRIBUTION

Vertical Angle	Horizontal Angles					Zonal Lumens
	0	22.5	45	67.5	90	
0	688	688	688	688	688	
5	676	691	676	690	700	37
15	666	677	681	676	681	161
25	631	628	646	652	659	274
35	545	550	567	576	582	344
45	417	430	450	449	450	350
55	253	272	296	291	291	278
65	151	157	164	154	152	180
75	67	73	72	62	56	91
85	14	15	17	15	13	28
90	2	2	2	2	2	

LUMINANCE DATA (CD/M²)

Vertical Angle	Horizontal Angles		
	0	45	90
45	4910	4761	5244
55	3315	3385	3761
65	2301	2105	2280
75	1266	1099	1044
85	366	327	332

COEFFICIENTS OF UTILIZATION (%)

Ceiling	80				70				50		
	70	50	30	10	70	50	30	10	50	30	10
Wall											
0	87	87	87	87	85	85	85	85	81	81	81
1	80	77	74	72	78	75	73	71	72	70	68
2	73	68	64	60	72	67	63	59	64	61	58
3	67	60	55	51	66	59	54	50	57	53	49
4	62	54	48	43	60	53	47	43	51	46	43
5	57	48	42	38	56	48	42	38	46	41	37
6	53	44	38	33	52	43	37	33	42	37	33
7	49	40	34	29	48	39	34	29	38	33	29
8	46	36	31	26	45	36	30	26	34	30	26
9	43	34	28	24	42	33	28	24	32	27	24
10	40	31	25	22	39	31	25	22	30	25	22

Based on floor reflectance of 20

i All IES files are available for download at: www.axislighting.com