



Glo Lens - down



StepLens 1.5 - down



Flush Spotless lens - down

Project _____

Type _____

Notes _____

PERFORMANCE PER LINEAR FOOT AT 3500K

NOMINAL LUMEN OUTPUT	INPUT WATTS*	EFFICACY	SHIELDING
1000 lm/ft	8.2 W/ft	114 lm/W	SO

Please consult factory for custom lumen output and wattage.

Spotless Lens

Glo lens

StepLens
1.5"



Ordering Guide

TB4DLED		NOM. LUM/FT DOWN		CRI		COLOR TEMP.		SHIELDING	
PRODUCT ID									
TB4DLED	Twin BEAM4 - Pendant Direct LED	400	400 lm/ft - Minimum	80	80 CRI	27	2700 K	SO	spotless lens
		1000	1000 lm/ft - Maximum	90	90 CRI	30	3000 K	0.25G	0.25" Glo lens
						35	3500 K	1.5M	StepLens , lum. end cap
						40	4000 K		
Outputs between listed min and max are available. Consult factory for outputs outside of the listed range.						Consult Axitune spec sheet for Axis color technology options		Choose only one of the options above; SurroundLite not available with direct	

LENGTH (FT)	MR (OPTIONAL)	FINISH	VOLTAGE	DRIVER	CIRCUITS
2 2'	DMLED(#) downlight modle LED	AP aluminum paint	120 120 V	DP dimming (0-10V) 1%	1 1 circuit 2 2 circuits +E(#) emergency circuit ⁽³⁾ +NL(#) night light circuit ⁽³⁾ +GTD(#) generator transfer device ⁽³⁾ +M MR
3 3'		W white	277 277 V	LT Lutron ⁽¹⁾	
4 4'		BLK black	347 347 V	BI bi-level dimming	
5 5'		C custom	UNV universal	O other ⁽²⁾	
8 8'					
12 12'					
S# System Run					
Add 6" per lamp. Specify quantity Separate circuits included Requires 120V or 277V				(1) Specify system (2) Please consult factory; see page 2 Consult Axitune spec sheet for Axis color driver options	(3) Specify quantity

MOUNTING/SUSPENSION	BATTERY (OPTIONAL)	OTHER (OPTIONAL)	IC CONTROLS (OPTIONAL)	CUSTOM (OPTIONAL)
CA(#) drywall+cable length (36" std.) CT9(#) TB/TG 9/16+cable length (36" std.) CT15(#) TB/TG15/16+cable length (36" std.) CTS(#) ST+cable length (36" std.) SA(#) drywall+stem length >48" (18" std.)	B# battery pack (integral)	F fuse ⁽⁴⁾	DS# daylight sensor OS# occupancy sensor DOS# daylight & occupancy sensor EN# Enlighted integral ⁽⁵⁾ ENR# Enlighted remote ⁽⁵⁾ WC# wireless control dimming	C custom
White canopy standard	Minimum 5ft; Not available with 347V Please consult factory	(4) Requires 120V or 277V	(5) Please consult factory Specify quantity. Requires 8" blank. See integrated controls guide for more details.	Please specify

● **CONSTRUCTION**

Housing	Extruded aluminum (0.075" nominal) Up to 70% recycled content
End Cap	Cast aluminum
Interior Brackets	Die formed sheet steel (20 gauge)
Reflectors	White powder coated sheet steel (22 gauge)
Lenses	Extruded acrylic (0.070" nominal)
Hanger	Die cast aluminum
Suspension	Sliding aircraft cable along product length

● **ELECTRICAL**

Lutron driver*	LDE1 - EcoSystem H-Series (1%) LDE5 - EcoSystem 5-Series (5%) LTE - Hi-Lume® A-series 2Wires Forward Phase (1%) *Consult factory
Other drivers	DALI - Digital Addressable Lighting Interface DMX - Digital Multiplex LV - line voltage - Advance Mark 10 Xitanium SR - For wireless sensor POE (Power over Ethernet) - Low Voltage Lighting System.
Emergency	Integral emergency battery pack or emergency circuit optional.
Input Voltage	120V, 277V, 347V, UNV.

i Incorporating these components may have limitations or affect the length of the luminaire. Please contact factory for more details.

● **LED SYSTEM**

CRI	Minimum 80 or 90 color rendering index.
CCT	Choice of 2700K, 3000K, 3500K and 4000K color temperature with a great color consistency (within 3-step MacAdam ellipse). Both within fixture and fixture to fixture.
LED life	Minimum 50,000h with 85% of lumen maintenance in 25°C ambient temperature, in compliance with IES LM-80 testing measurements.
Thermal Management	Aluminum housing acting as the heat sink to maximize life.
Environment	Dry and damp rated in operating ambient temperatures of 0-40°C (32-104F).

● **OPTICS**

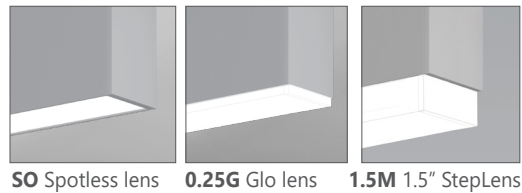

SPOTLESS LENS

Frosted acrylic snap-in micro lens

GLO LENS

0.25" frosted acrylic drop lens. Patented design.

STEPLENS

1.5" StepLens, illuminated end cap.

● **SYSTEM (S#)**

TWIN BEAM4 SurroundLite linear systems, with the use of a strong profile, allow for a nearly hair thin connection system of continuous runs. Lengths of 4', 8', 12' as well as custom lengths are available. Runs of TWIN BEAM2 SurroundLite that are greater than 12' in length are designated as systems (S#). This means that the run is comprised of a combination of 4', 8' and/or 12' sections to be assembled on site using our joining system. System runs with SurroundLite available in 1' increments only. For more information on systems and joining, please refer to the BEAM installation sheets available for download at www.axislighting.com.

● **WARRANTY**

Axis Lighting will warrant defective LEDs, boards, and drivers for 5 years from date of purchase. Warranty is valid if luminaire is installed and used according to specifications. If defective, Axis will send replacement boards or drivers at no cost along with detailed replacement instructions and instructions on how to return defective components to Axis.

● **Options**

OUTPUT	CRI	COLOR TEMP.	SHIELDING	LENGTH	FINISH	VOLTAGE	DRIVER
400 lm/ft	80	3000 K	FL	2'	white	universal	DP
650 lm/ft		3500 K	1.5M	3'			
850 lm/ft		4000 K		4'			
				5'			
				6'			
				8'			
				12'			

● **JOINERS**

TWIN BEAM4 SurroundLite luminaires feature the joining mechanism shown below. This mechanism joins and aligns multiple luminaires to create long continuous runs of light.

NOTE: Mount each system segment individually.

Do not assemble system prior to mounting

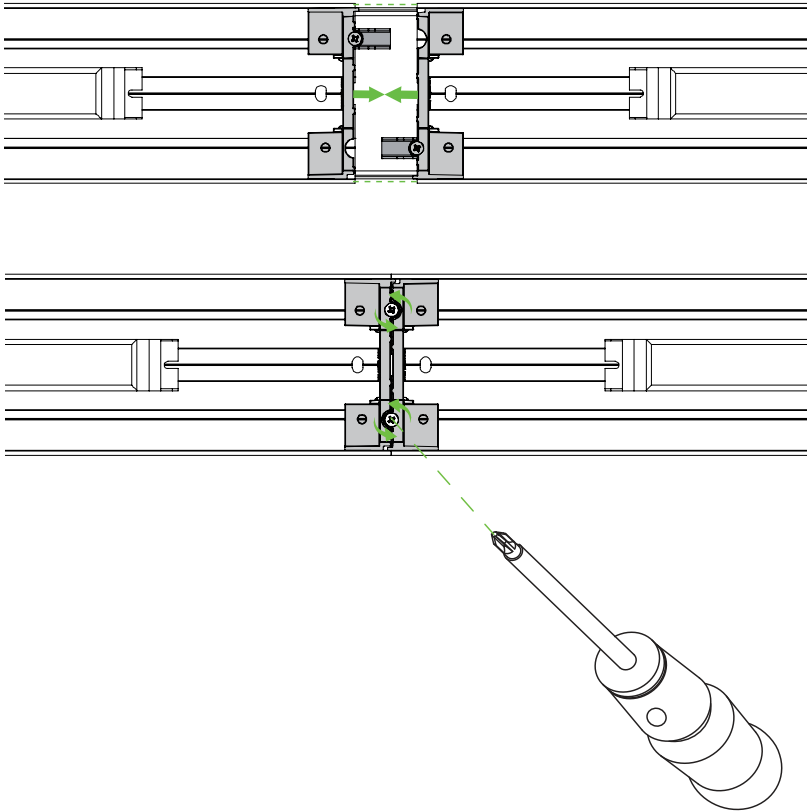

● **SECTION VIEWS**

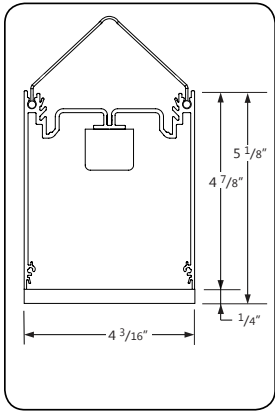

0.25G 0.25" Glo lens - Direct

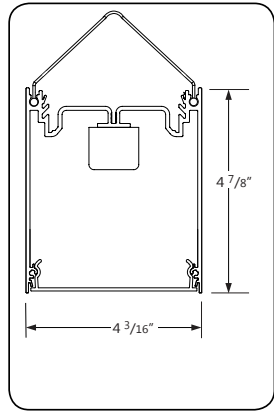

SO Spotless lens - Direct

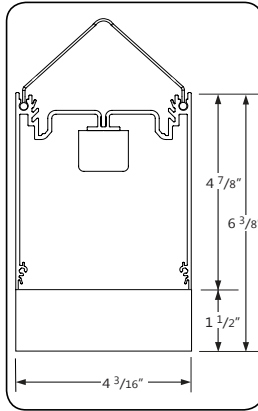

1.5M 1.5" StepLens - Direct

● **MOUNTING OPTIONS**

CT TILE CEILING - ON GRID

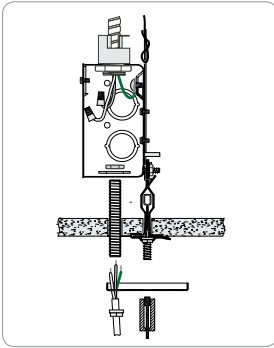

Power feed

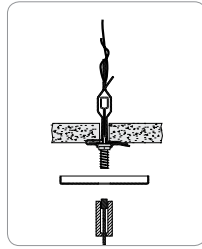

Non power feed

CA DRYWALL CEILING

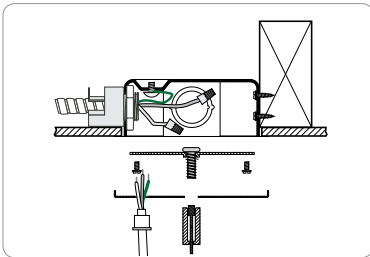

Power feed

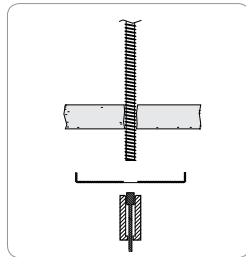

Non power feed

SA STEM MOUNT IN DRYWALL CEILING

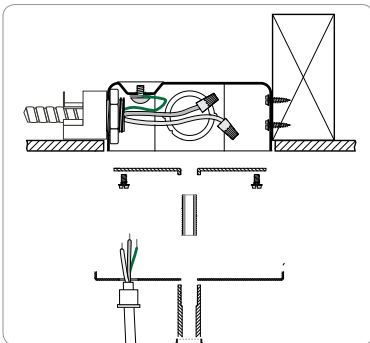

Power feed

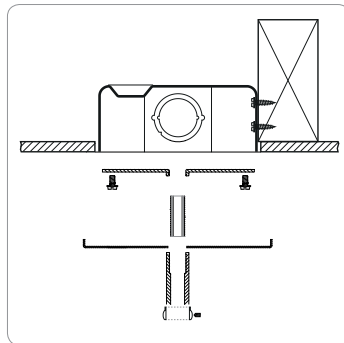

Non power feed

● **OTHER MOUNTING OPTIONS**

TWIN BEAM4 SurroundLite is also available with wall mounted option.

i Specification sheets and installation sheets for all mountings for TWIN BEAM4 SurroundLite luminaires are available for download at www.axislighting.com

● **DOWNLIGHT MODLE LED**

Blank DMLED Quantity

Extruded aluminum (0.075" nominal) 1.4" diameter
For every 4' section, there may be up to a maximum of 4 x DMLED lamps.
Each DMLED lamp is placed centered on a blank section 6" in length.

Spacing

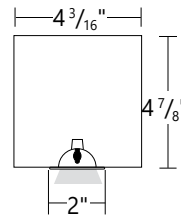

For a series of MR11's within a given section length, they will be spaced evenly on a longer blank section.
The directed light of DMLED lamps are fixed downward.
Custom spacing may be available on special request.

Between sections

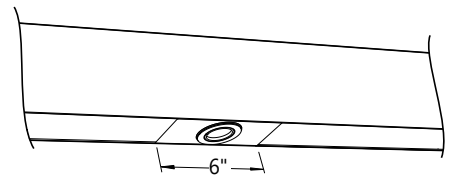

At luminaire ends

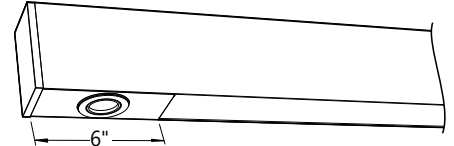

Several in a long blank section

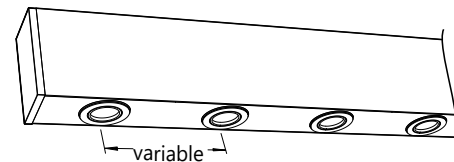

Beam Angle	45 nominal degrees
Input Watts	3W
Nominal Lumens	50 lumens
Efficacy	17 lumens per watt
Color Rendering Index (CRI)	80
Life	25,000 hours at L ₇₀
Correlated color temperature (CCT)	2700K

i More options are available upon request. Please consult factory.

● **FINISH**

Aluminium paint, powder coated and custom finishes are also available.

● **APPROVALS**

Certified to UL and CSA standards 
Meets NYC requirements
Meets ADA requirements.
Suitable for damp locations.

● **PHOTOMETRIC DATA**

0.25G 0.25" Glo lens

Uplight
0 lm/ft
Downlight
400 lm/ft

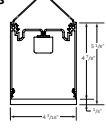

PHOTOMETRIC CURVE

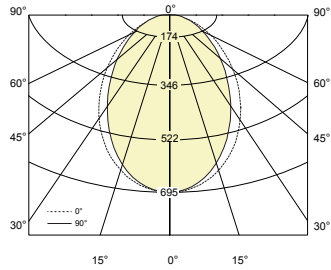

Lumen/ft up: 0 lm/ft
Lumen/ft down: 400 lm/ft
Total Lumens: 3706 lm (for 4ft)
Input Watts: 14 W
Efficacy: 114 lm/W

IES FILE: TB4DILED-0-1000-80-35-.25G-L-4.IES

TESTED ACCORDING TO IES LM-79-2008

CANDELA DISTRIBUTION

Vertical Angle	Horizontal Angles				
	0	22.5	45	67.5	90
0	695	695	695	695	695
5	689	690	689	690	691
15	637	640	645	651	654
25	547	553	565	577	584
35	439	446	463	480	487
45	332	339	355	372	379
55	237	242	255	268	272
65	157	160	166	173	175
75	91	92	93	92	90
85	40	39	35	30	26
90	20	18	14	8	3

ZONAL LUMENS

Zone	Lumens
0	
0-10	65
10-20	182
20-30	260
30-40	289
40-50	274
50-60	228
60-70	165
70-80	98
80-90	38
90	

LUMINANCE DATA (cd/m²)

Vertical Angle	Horizontal Angles		
	0	45	90
45	37132	26939	25412
55	32606	20894	19193
65	29152	15379	13377
75	27491	10153	7838
85	34024	4955	2695

0.25G 0.25" Glo lens

Uplight
0 lm/ft
Downlight
1000 lm/ft

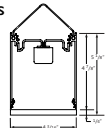

PHOTOMETRIC CURVE

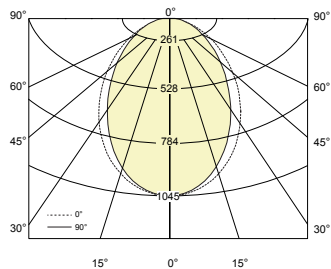

Lumen/ft up: 0 lm/ft
Lumen/ft down: 925 lm/ft
Total Lumens: 3706 lm (for 4ft)
Input Watts: 32.6 W
Efficacy: 114 lm/W

IES FILE: TB4DILED-0-1000-80-35-.25G-L-4.IES

TESTED ACCORDING TO IES LM-79-2008

CANDELA DISTRIBUTION

Vertical Angle	Horizontal Angles				
	0	22.5	45	67.5	90
0	1611	1611	1611	1611	1611
5	1601	1599	1597	1597	1596
15	1515	1508	1495	1483	1476
25	1352	1338	1308	1281	1267
35	1129	1112	1072	1034	1017
45	878	862	823	785	768
55	631	620	590	561	549
65	404	400	386	370	363
75	209	214	215	213	211
85	60	70	82	90	92
90	7	18	32	43	46

ZONAL LUMENS

Zone	Lumens
0	
0-10	151
10-20	421
20-30	602
30-40	670
40-50	636
50-60	529
60-70	382
70-80	227
80-90	89
90	

LUMINANCE DATA (cd/m²)

Vertical Angle	Horizontal Angles		
	0	45	90
45	98300	62398	51500
55	86890	48395	38640
65	75213	35623	27816
75	62856	23518	18392
85	51359	11477	9578

● **PHOTOMETRIC DATA**

1.5G 1.5" Step lens

Uplight
0 lm/ft
Downlight
400 lm/ft

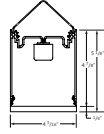

PHOTOMETRIC CURVE

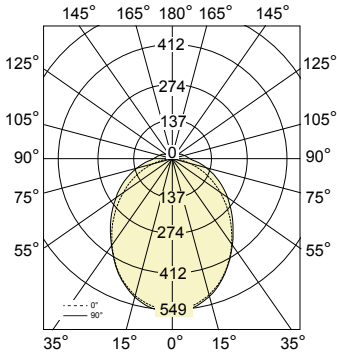

Lumen/ft up: **0 lm/ft**
Lumen/ft down: **400 lm/ft**
Total Lumens: **1600 lm (for 4ft)**
Input Watts: **14.4 W**
Efficacy: **111 lm/W**

IES FILE: TB4DLED-400-80-35-1.5M-4-W.IES

TESTED ACCORDING TO IES LM-79-2008

CANDELA DISTRIBUTION

Vertical Angle	Horizontal Angles				
	0	22.5	45	67.5	90
0	547	547	547	547	547
5	541	543	543	546	548
15	510	516	516	515	516
25	453	458	457	456	456
35	378	384	384	382	381
45	296	305	310	312	312
55	217	230	240	246	248
65	144	160	176	187	189
75	79	99	118	132	134
85	27	49	71	84	87
90	10	31	53	66	68
95	8	27	47	58	60
105	6	21	38	47	49
115	5	14	30	38	40
125	3	9	22	30	32
135	2	5	14	21	23
145	1	1	8	12	13
155	1	0	1	5	6
165	0	0	0	0	0
175	0	0	0	0	0
180	0	0	0	0	0

ZONAL LUMENS

Zone	Lumens
0	
0-10	52
10-20	145
20-30	210
30-40	239
40-50	238
50-60	212
60-70	171
70-80	121
80-90	72
90	
90-100	46
100-110	35
110-120	26
120-130	18
130-140	10
140-150	4
150-160	1
160-170	0
170-180	0
180	

LUMINANCE DATA (cd/m²)

Vertical Angle	Horizontal Angles		
	0	45	90
0			
45	3270	2730	2573
55	2920	2376	2255
65	2571	2056	1988
75	2182	1761	1722
85	1817	1509	1495

1.5G 1.5" Step lens

Uplight
0 lm/ft
Downlight
500 lm/ft

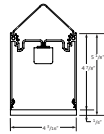

PHOTOMETRIC CURVE

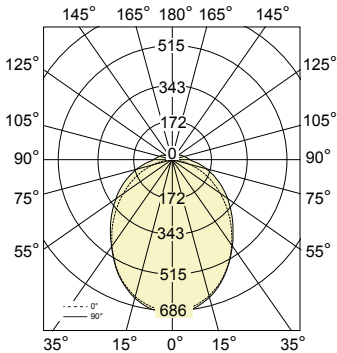

Lumen/ft up: **0 lm/ft**
Lumen/ft down: **500 lm/ft**
Total Lumens: **2000 lm (for 4ft)**
Input Watts: **18 W**
Efficacy: **111 lm/W**

IES FILE: TB4DLED-500-80-35-1.5M-4-W.IES

TESTED ACCORDING TO IES LM-79-2008

CANDELA DISTRIBUTION

Vertical Angle	Horizontal Angles				
	0	22.5	45	67.5	90
0	684	684	684	684	684
5	676	679	678	682	685
15	638	644	644	643	646
25	566	573	572	570	570
35	472	480	480	478	477
45	370	382	387	390	390
55	272	287	300	308	310
65	180	200	219	234	237
75	98	123	148	164	168
85	34	61	89	105	108
90	13	39	66	82	85
95	11	34	59	73	76
105	8	26	48	59	61
115	6	17	37	48	50
125	4	11	27	37	40
135	3	6	17	26	29
145	2	1	10	15	16
155	1	1	2	6	7
165	0	0	0	0	0
175	0	0	0	0	0
180	0	0	0	0	0

ZONAL LUMENS

Zone	Lumens
0	
0-10	65
10-20	181
20-30	263
30-40	299
40-50	297
50-60	266
60-70	214
70-80	151
80-90	90
90	
90-100	57
100-110	44
110-120	33
120-130	22
130-140	13
140-150	6
150-160	2
160-170	0
170-180	0
180	

LUMINANCE DATA (cd/m²)

Vertical Angle	Horizontal Angles		
	0	45	90
0			
45	4087	3413	3216
55	3650	2970	2819
65	3213	2570	2485
75	2728	2201	2153
85	2271	1887	1868

● PHOTOMETRIC DATA

1.5G 1.5" Step lens

Uplight
0 lm/ft
Downlight
600 lm/ft

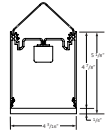

PHOTOMETRIC CURVE

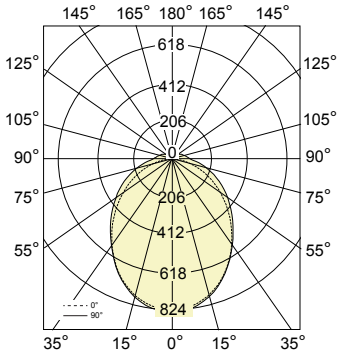

Lumen/ft up: 0 lm/ft
Lumen/ft down: 600 lm/ft
Total Lumens: 1600 lm (for 4ft)
Input Watts: 21.6 W
Efficacy: 111 lm/W

IES FILE: TB4DLED-600-80-35-1.5M-4-W.IES

TESTED ACCORDING TO IES LM-79-2008

CANDELA DISTRIBUTION

Vertical Angle	Horizontal Angles				
	0	22.5	45	67.5	90
0	820	820	820	820	820
5	811	815	814	818	822
15	766	773	773	772	775
25	679	687	686	684	685
35	567	575	576	574	572
45	444	458	464	468	468
55	326	345	360	369	372
65	216	240	263	280	284
75	118	148	178	197	201
85	41	73	107	126	130
90	15	46	79	98	102
95	13	41	70	88	91
105	10	31	57	70	74
115	7	21	44	58	60
125	5	13	33	44	48
135	3	7	20	31	34
145	2	1	11	18	20
155	1	1	2	7	9
165	0	0	0	0	0
175	0	0	0	0	0
180	0	0	0	0	0

ZONAL LUMENS

Zone	Lumens
0	
0-10	77
10-20	217
20-30	315
30-40	359
40-50	356
50-60	319
60-70	257
70-80	181
80-90	108
90	
90-100	69
100-110	53
110-120	39
120-130	26
130-140	15
140-150	7
150-160	2
160-170	0
170-180	0
180	

LUMINANCE DATA (cd/m²)

Vertical Angle	Horizontal Angles		
	0	45	90
45	4905	4096	3860
55	4380	3565	3383
65	3856	3084	2982
75	3274	2642	2583
85	2726	2264	2242

1.5G 1.5" Step lens

Uplight
0 lm/ft
Downlight
750 lm/ft

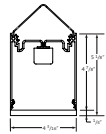

PHOTOMETRIC CURVE

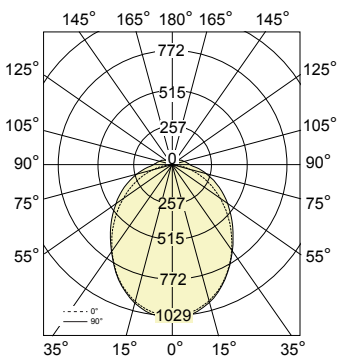

Lumen/ft up: 0 lm/ft
Lumen/ft down: 750 lm/ft
Total Lumens: 3000 lm (for 4ft)
Input Watts: 26.9 W
Efficacy: 112 lm/W

IES FILE: TB4DLED-750-80-35-1.5M-4-W.IES

TESTED ACCORDING TO IES LM-79-2008

CANDELA DISTRIBUTION

Vertical Angle	Horizontal Angles				
	0	22.5	45	67.5	90
0	1025	1025	1025	1025	1025
5	1014	1019	1017	1023	1027
15	957	967	967	965	968
25	849	859	857	855	856
35	708	719	720	717	715
45	555	573	580	584	584
55	408	431	450	462	465
65	270	300	329	351	355
75	148	185	222	247	251
85	51	91	133	158	163
90	19	58	99	123	128
95	16	51	88	109	113
105	12	39	71	88	92
115	9	26	56	72	75
125	6	17	41	56	59
135	4	9	25	39	43
145	2	2	14	22	25
155	2	1	2	9	11
165	0	0	0	0	0
175	0	0	0	0	0
180	0	0	0	0	0

ZONAL LUMENS

Zone	Lumens
0	
0-10	97
10-20	272
20-30	394
30-40	449
40-50	446
50-60	398
60-70	321
70-80	226
80-90	135
90	
90-100	86
100-110	66
110-120	49
120-130	33
130-140	19
140-150	8
150-160	2
160-170	0
170-180	0
180	

LUMINANCE DATA (cd/m²)

Vertical Angle	Horizontal Angles		
	0	45	90
45	6131	5120	4824
55	5475	4456	4228
65	4820	3855	3727
75	4092	3302	3229
85	3407	2830	2802

● **PHOTOMETRIC DATA**

1.5G 1.5" Step lens

Uplight
0 lm/ft
Downlight
1000 lm/ft

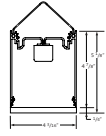

PHOTOMETRIC CURVE

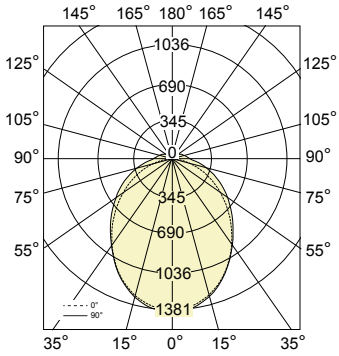

Lumen/ft up: 0 lm/ft
Lumen/ft down: 1000 lm/ft
Total Lumens: 4024 lm (for 4ft)
Input Watts: 35.8 W
Efficacy: 112 lm/W
IES FILE: TB4DLED-1000-80-35-1.5M-4-W.IES

TESTED ACCORDING TO IES LM-79-2008

CANDELA DISTRIBUTION

Vertical Angle	Horizontal Angles				
	0	22.5	45	67.5	90
0	1376	1376	1376	1376	1376
5	1361	1367	1365	1372	1378
15	1284	1297	1297	1295	1299
25	1139	1152	1150	1147	1148
35	950	965	966	962	960
45	745	768	779	784	784
55	547	578	603	619	623
65	363	402	441	470	477
75	198	248	298	331	337
85	68	122	179	212	218
90	26	78	133	165	171
95	21	68	118	147	152
105	16	52	96	118	123
115	12	35	74	97	101
125	9	22	55	74	80
135	5	12	34	52	57
145	3	2	19	30	33
155	2	1	3	12	15
165	0	0	0	0	0
175	0	0	0	0	0
180	0	0	0	0	0

ZONAL LUMENS

Zone	Lumens
0	
0-10	130
10-20	364
20-30	528
30-40	602
40-50	598
50-60	534
60-70	430
70-80	304
80-90	181
90	
90-100	115
100-110	89
110-120	66
120-130	44
130-140	25
140-150	11
150-160	3
160-170	0
170-180	0
180	

LUMINANCE DATA (cd/m²)

Vertical Angle	Horizontal Angles		
	0	45	90
45	8225	6868	6472
55	7344	5977	5672
65	6466	5171	5000
75	5489	4429	4332
85	4571	3796	3759