

Flush Spotless Lens - down  
Glo Lens - up

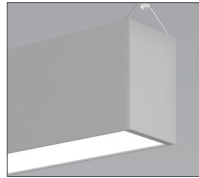

Flush spotless lens up and down

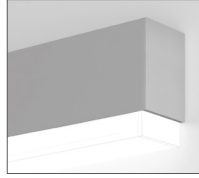

Flush Spotless Lens - up  
1.25" StepLens - down

Project \_\_\_\_\_

Type \_\_\_\_\_

Notes \_\_\_\_\_

**PERFORMANCE PER LINEAR FOOT AT 3500K**

NOMINAL LUMEN OUTPUT		INPUT WATTS*	EFFICACY	SHIELDING I/D
UPLIGHT	DOWNLIGHT			
400 lm/ft	400 lm/ft	6.78 W/ft	118 lm/W	0.25G/0.25G
400 lm/ft	400 lm/ft	7.13 W/ft	112 lm/W	SO/0.25G
400 lm/ft	1000 lm/ft	12.04 W/ft	116 lm/ft	0.25G/0.25G
400 lm/ft	1000 lm/ft	12.4 W/ft	113 lm/ft	SO/0.25G
1100 lm/ft	400 lm/ft	12.5 W/ft	131 lm/W	0.25G/0.25G
1100 lm/ft	400 lm/ft	13.43 W/ft	112 lm/W	SO/0.25G
1100 lm/ft	1100 lm/ft	17.48 W/ft	119 lm/W	0.25G/0.25G
1100 lm/ft	1100 lm/ft	18.7 W/ft	112 lm/W	SO/0.25G

Please consult factory for custom lumen output and wattage.

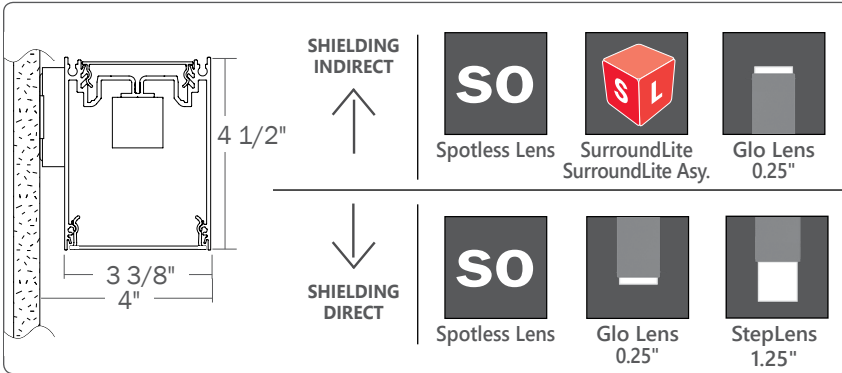

**Ordering Guide**

TB3WDILED		PRODUCT ID		NOM. LUM/FT UP		NOM. LUM/FT DOWN		CRI		COLOR TEMP.		SHIELDING INDIRECT		SHIELDING DIRECT	
TB3WDILED	Twin BEAM3 - Wall Direct/Indirect LED	400	400 lm/ft-Min. 1100 1100 lm/ft-max.	400	400 lm/ft-min. 1000 1000 lm/ft-max.	80	80 CRI 90 90 CRI	27	2700 K 30 3000 K 35 3500 K 40 4000 K	SO	spotless lens SL surroundlite SLA surroundlite asymmetric 0.25G 0.25" Glo lens	SO	spotless lens 0.25G 0.25" Glo lens 1.25M 1.25" StepLens, lum. end cap		
				Outputs between listed min and max are available. Consult factory for outputs outside of the listed range.								Choose only one of the options above			
												Choose only one of the options above; SurroundLite not available with direct			

LENGTH (FT)	MR (OPTIONAL)	FINISH	VOLTAGE	DRIVER	CIRCUITS
2 2' 3 3' 4 4' 5 5' 8 8' 12 12' S# System Run *	DMLLED(#) downlight modle LED	AP aluminum paint W white BLK black C custom	120 120 V 277 277 V 347 347 V UNV universal	DP dimming (0-10V) 1% LT Lutron (1) BI bi-level dimming O other (2)	1 1 circuit 2 2 circuits +E(#) emergency circuit (3) +NL(#) night light circuit (3) +GTD(#) generator transfer device (3) +M MR
* SurroundLite available in 1' increments	Add 6" per lamp, Specify quantity Separate circuits included Requires 120V or 277V			(1) Specify system (2) Please consult factory, see page 2	(3) Specify quantity

BATTERY (OPTIONAL)	OTHER (OPTIONAL)	IC CONTROLS (OPTIONAL)	CUSTOM (OPTIONAL)
B# battery pack (integral)	F fuse (4)	DS# daylight sensor OS# occupancy sensor DOS# daylight & occupancy sensor EN# Enlighted integral (5) ENR# Enlighted remote (5) WC# wireless control dimming	C custom
Minimum 5ft; Not available with 347V Please consult factory	(4) Requires 120V or 277V	(5) Please consult factory Specify quantity. Requires 8" blank. See integrated controls guide for more details.	Please specify

● **CONSTRUCTION**

<b>Housing</b>	Extruded aluminum (0.075" nominal) Up to 70% recycled content
<b>End Cap</b>	Cast aluminum
<b>Interior Brackets</b>	Die formed sheet steel (20 gauge)
<b>Reflectors</b>	White powder coated sheet steel (22 gauge)
<b>Lenses</b>	Extruded acrylic (0.070" nominal)
<b>Mounting</b>	Sheet metal bracket with fixture-mounted clip

● **ELECTRICAL**

<b>Lutron driver*</b>	LDE1 - EcoSystem H-Series (1%) LDE5 - EcoSystem 5-Series (5%) LTE - Hi-Lume® A-series 2Wires Forward Phase (1%) <small>*Consult factory</small>
<b>Other drivers</b>	DALI - Digital Addressable Lighting Interface DMX - Digital Multiplex LV - line voltage - Advance Mark 10 Xitanium SR - For wireless sensor POE (Power over Ethernet) - Low Voltage Lighting System.
<b>Emergency</b>	Integral emergency battery pack or emergency circuit optional.
<b>Input Voltage</b>	120V, 277V, 347V, UNV.

❗ Incorporating these components may have limitations or affect the length of the luminaire. Please contact factory for more details.

● **LED SYSTEM**

<b>CRI</b>	Minimum 80 or 90 color rendering index.
<b>CCT</b>	Choice of 2700K, 3000K, 3500K and 4000K color temperature with a great color consistency (within 3-step MacAdam ellipse). Both within fixture and fixture to fixture.
<b>LED life</b>	Minimum 50,000h with 85% of lumen maintenance in 25°C ambient temperature, in compliance with IES LM-80 testing measurements.
<b>Thermal Management</b>	Aluminum housing acting as the heat sink to maximize life.
<b>Environment</b>	Dry and damp rated in operating ambient temperatures of 0-40°C (32-104F).

● **OPTICS**



50 Spotless lens

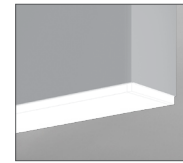

0.25G Glo lens

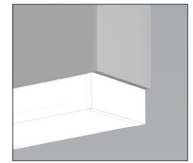

1.25M 1.25" StepLens

**SPOTLESS LENS**

Frosted acrylic snap-in micro lens

**GLO LENS**

0.25" frosted acrylic drop lens. Patented design.

**STEPLENS**

1.25" StepLens, illuminated end cap.

● **SYSTEM (S#)**

TWIN BEAM3 SurroundLite linear systems, with the use of a strong profile, allow for a nearly hair thin connection system of continuous runs. Lengths of 4', 8', 12' as well as custom lengths are available. Runs of TWIN BEAM3 SurroundLite that are greater than 12' in length are designated as systems (S#). This means that the run is comprised of a combination of 4', 8' and/or 12' sections to be assembled on site using our joining system. For more information on systems and joining, please refer to the BEAM installation sheets available for download at [www.axislighting.com](http://www.axislighting.com).

● **WARRANTY**

Axis Lighting will warrant defective LEDs, boards, and drivers for 5 years from date of purchase. Warranty is valid if luminaire is installed and used according to specifications. If defective, Axis will send replacement boards or drivers at no cost along with detailed replacement instructions and instructions on how to return defective components to Axis.

● **JOINERS**

TWIN BEAM3 SurroundLite luminaires feature the joining mechanism shown below. This mechanism joins and aligns multiple luminaires to create long continuous runs of light.

**NOTE:** Mount each system segment individually.

**Do not assemble system prior to mounting.**

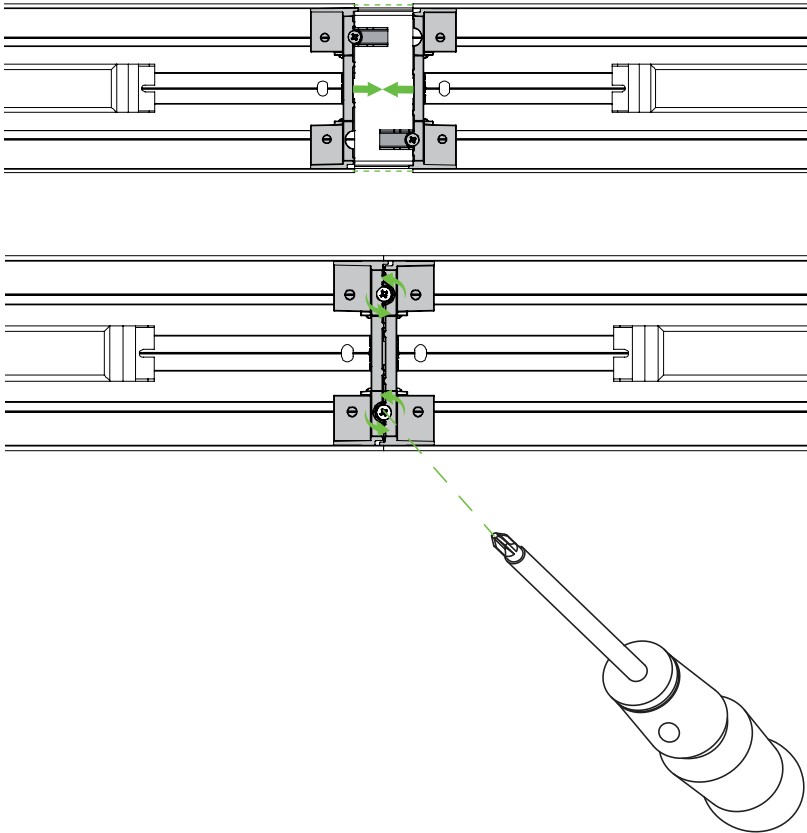

● **SECTION VIEWS**

**0.25G 0.25" Glo lens - Indirect**

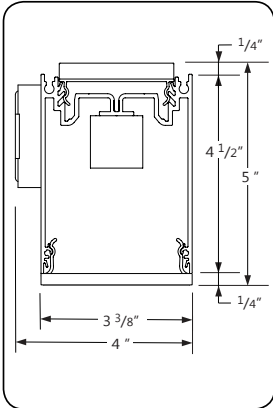

**0.25G 0.25" Glo lens - Direct**

**SL SurroundLite - Indirect**

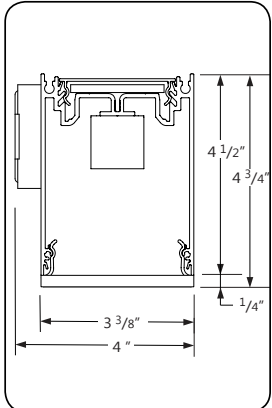

**0.25G 0.25" Glo lens - Direct**

**SO Spotless lens - Indirect**

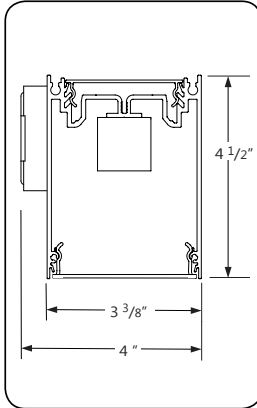

**SO Spotless lens - Direct**

**SL SurroundLite - Indirect**

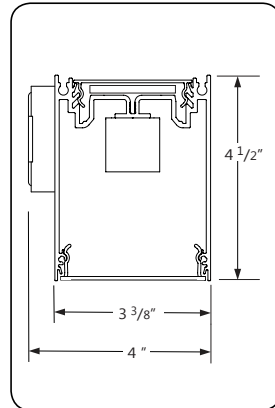

**SO Spotless lens - Direct**

**SO Spotless lens - Indirect**

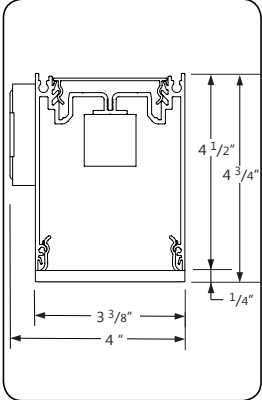

**0.25G 0.25" Glo lens - Direct**

**SL SurroundLite - Indirect**

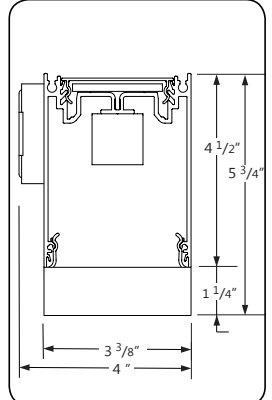

**1.25M 1.25" StepLens - Direct**

**SO Spotless lens - Indirect**

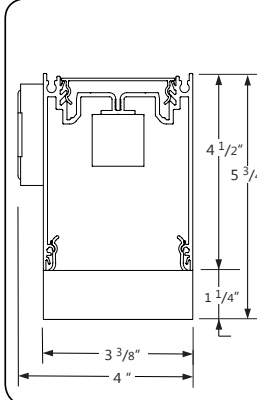

**1.25M 1.25" StepLens - Direct**

**0.25G 0.25" Glo lens - Indirect**

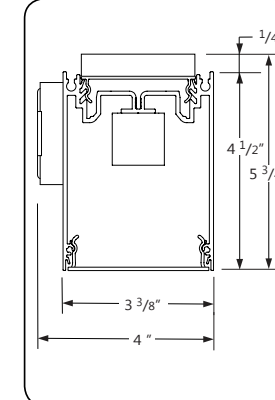

**SO Spotless lens - Direct**

**SLA SurroundLite Asymmetric - Indirect**

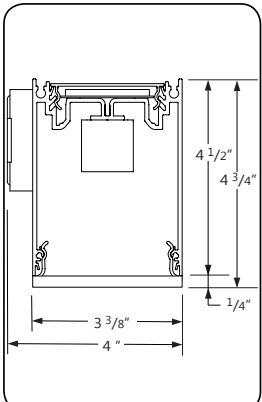

**0.25G 0.25" Glo lens - Direct**

**SLA SurroundLite Asymmetric - Indirect**

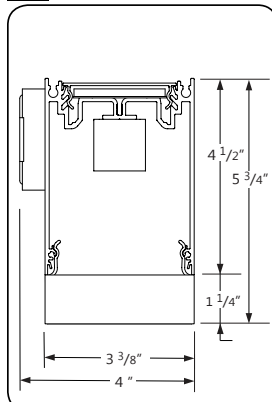

**1.25M 1.25" StepLens - Direct**

**SLA SurroundLite Asymmetric - Indirect**

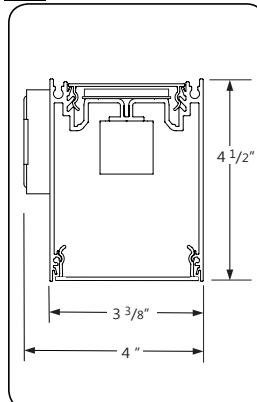

**SO Spotless lens - Direct**

**0.25G 0.25" Glo lens - Indirect**

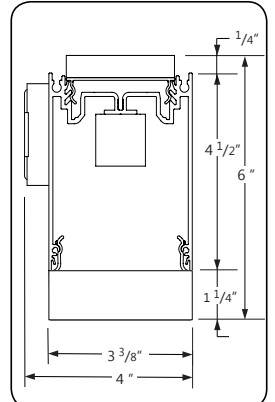

**1.25M 1.25" StepLens - Direct**

● **MOUNTING OPTIONS**

**HORIZONTAL MOUNTING DETAILS**

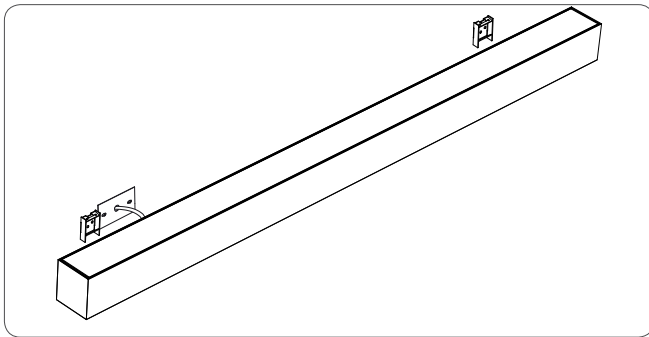

**MOUNTING BRACKETS**

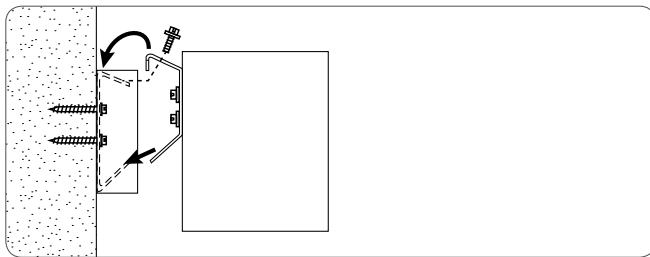

**SIDE VIEW**

● **OTHER MOUNTING OPTIONS**

TWIN BEAM3 SurroundLite is also available with pendant mounted option.

**i** Specification sheets and installation sheets for all mountings for TWIN BEAM3 SurroundLite luminaires are available for download at [www.axislighting.com](http://www.axislighting.com)

● **DOWNLIGHT MODLE LED**

**Blank DM LED Quantity** Extruded aluminum (0.075" nominal) 1.4" diameter  
For every 4' section, there may be up to a maximum of 4 x DM LED lamps.

**Spacing** Each DM LED lamp is placed centered on a blank section 6" in length.

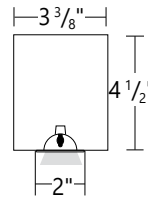

For a series of DM's within a given section length, they will be spaced evenly on a longer blank section. The directed light of DM LED lamps are fixed downward. Custom spacing may be available on special request.

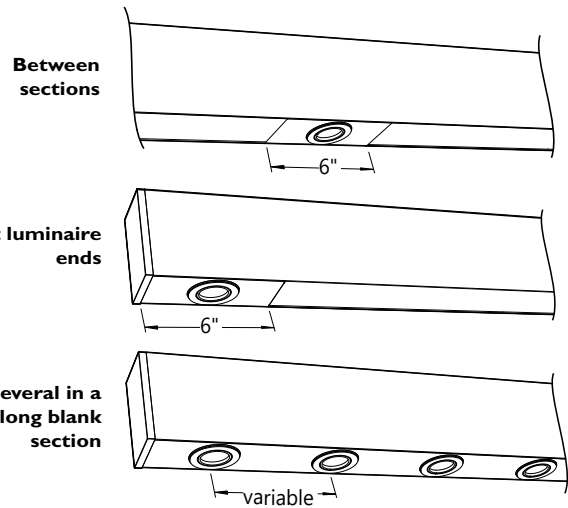

**Beam Angle** 45 nominal degrees  
**Input Watts** 3W  
**Nominal Lumens** 50 lumens  
**Efficacy** 17 lumens per watt  
**Color Rendering Index (CRI)** 80  
**Life** 25,000 hours at L<sub>70</sub>  
**Correlated color temperature (CCT)** 2700K

**i** More options are available upon request. Please consult factory.

● **FINISH**

Aluminium paint, powder coated and custom finishes are also available.

● **APPROVALS**

Certified to UL and CSA standards  
Meets NYC requirements  
Meets ADA requirements.  
Suitable for damp locations.



● **PHOTOMETRIC DATA**

**0.25G 0.25 Glo Lens - Up**  
**0.25G 0.25 Glo Lens - Down**

Uplight  
**400 lm/ft**  
Downlight  
**400 lm/ft**

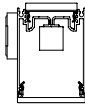

**PHOTOMETRIC CURVE**

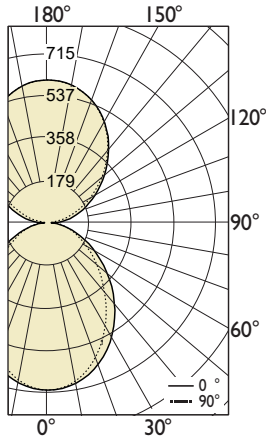

**Lumen/ft up: 1601 lm/ft**  
**Lumen/ft down: 1603 lm/ft**  
**Total Lumens: 3202 lm (for 4ft)**  
**Input Watts: 25.2 W**  
**Efficacy: 31.8 lm/W**

IES FILE: TB3DILED-400-400-80-35-0.25G-0.25G-4.IES

TESTED ACCORDING TO IES LM-79-2008

**CANDELA DISTRIBUTION**

Vertical Angle	Horizontal Angles				
	0	22.5	45	67.5	90
0	715	715	715	715	715
5	711	710	709	709	708
15	672	669	662	655	652
25	599	592	575	559	552
35	499	489	466	443	434
45	386	377	353	330	321
55	274	267	249	231	224
65	174	171	161	151	147
75	89	91	90	88	87
85	26	31	37	41	42
90	43	46	42	35	28
95	66	61	49	35	24
105	127	122	108	94	85
115	195	191	181	172	164
125	273	272	267	260	254
135	361	361	359	354	351
145	449	449	447	445	444
155	524	524	523	523	523
165	577	577	577	577	577
175	605	605	605	605	605
180	609	609	609	609	609

**ZONAL LUMENS**

Zone	Lumens
0	
0-10	67
10-20	186
20-30	265
30-40	291
40-50	273
50-60	223
60-70	160
70-80	95
80-90	43
90	
90-100	55
100-110	114
110-120	179
120-130	238
130-140	276
140-150	279
150-160	241
160-170	163
170-180	57
180	

**LUMINANCE DATA (cd/m²)**

Vertical Angle	Horizontal Angles		
	0	45	90
45	4800	4389	3989
55	4198	3820	3439
65	3612	3349	3060
75	3022	3062	2966
85	2608	3712	4200

**SO Spotless Lens - Up**  
**0.25G 0.25 Glo Lens - Down**

Uplight  
**400 lm/ft**  
Downlight  
**400 lm/ft**

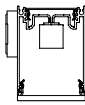

**PHOTOMETRIC CURVE**

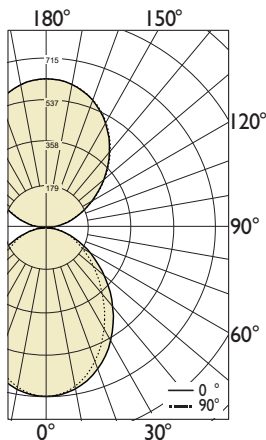

**Lumen/ft up: 1602 lm/ft**  
**Lumen/ft down: 1600 lm/ft**  
**Total Lumens: 3202 lm (for 4ft)**  
**Input Watts: 25.2 W**  
**Efficacy: 31.8 lm/W**

IES FILE: TB3DILED-400-400-80-35-SO-0.25G-4.IES

TESTED ACCORDING TO IES LM-79-2008

**CANDELA DISTRIBUTION**

Vertical Angle	Horizontal Angles				
	0	22.5	45	67.5	90
0	715	715	715	715	715
5	711	710	709	709	708
15	672	669	662	655	652
25	599	592	575	559	552
35	499	489	466	443	434
45	386	377	353	330	321
55	274	267	249	231	224
65	174	171	161	151	147
75	89	91	90	88	87
85	26	31	37	41	42
90	3	10	18	23	26
95	22	25	29	29	28
105	98	99	99	97	95
115	180	182	184	183	181
125	274	277	280	280	277
135	373	376	379	379	378
145	467	469	473	474	472
155	546	548	551	551	550
165	602	603	604	604	603
175	630	630	630	630	629
180	632	632	632	632	632

**ZONAL LUMENS**

Zone	Lumens
0	
0-10	67
10-20	186
20-30	265
30-40	291
40-50	273
50-60	223
60-70	160
70-80	95
80-90	40
90	
90-100	30
100-110	99
110-120	175
120-130	243
130-140	285
140-150	290
150-160	250
160-170	169
170-180	60
180	

**LUMINANCE DATA (cd/m²)**

Vertical Angle	Horizontal Angles		
	0	45	90
45	4800	4389	3989
55	4198	3820	3439
65	3612	3349	3060
75	3022	3062	2966
85	2608	3712	4200

**i** All IES files are available for download at: [www.axislighting.com](http://www.axislighting.com)

● **PHOTOMETRIC DATA**

**0.25G 0.25 Glo Lens - Up**  
**0.25G 0.25 Glo Lens - Down**

Uplight  
**400 lm/ft**  
Downlight  
**1000 lm/ft**

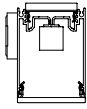

**PHOTOMETRIC CURVE**

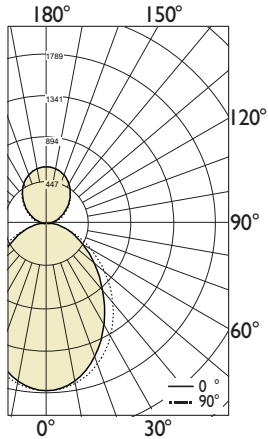

**Lumen/ft up: 1605 lm/ft**  
**Lumen/ft down: 4003 lm/ft**  
**Total Lumens: 5608 lm (for 4ft)**  
**Input Watts: 47.38 W**  
**Efficacy: 29.5 lm/W**

IES FILE: TB3DILED-400-1000-80-35-0.25G-0.25G-4.IES

TESTED ACCORDING TO IES LM-79-2008

**CANDELA DISTRIBUTION**

Vertical Angle	Horizontal Angles				
	0	22.5	45	67.5	90
0	1789	1789	1789	1789	1789
5	1777	1775	1773	1771	1771
15	1681	1673	1655	1637	1629
25	1498	1480	1439	1398	1380
35	1247	1223	1165	1109	1085
45	964	942	882	825	801
55	684	669	623	578	560
65	434	427	402	378	367
75	222	227	225	221	218
85	65	77	92	101	104
90	48	60	68	69	64
95	66	61	49	35	24
105	127	122	108	94	85
115	195	191	181	172	164
125	273	272	267	260	254
135	361	361	359	354	351
145	449	449	447	445	444
155	524	524	523	523	523
165	577	577	577	577	577
175	605	605	605	605	605
180	609	609	609	609	609

**ZONAL LUMENS**

Zone	Lumens
0	
0-10	168
10-20	465
20-30	661
30-40	729
40-50	682
50-60	559
60-70	400
70-80	238
80-90	102
90	
90-100	58
100-110	114
110-120	179
120-130	238
130-140	276
140-150	279
150-160	241
160-170	163
170-180	57
180	

**LUMINANCE DATA (cd/m²)**

Vertical Angle	Horizontal Angles		
	0	45	90
45	11999	10972	9972
55	10496	9550	8596
65	9031	8372	7649
75	7556	7654	7414
85	6520	9281	10500

**SO Spotless Lens - Up**  
**0.25G 0.25 Glo Lens - Down**

Uplight  
**400 lm/ft**  
Downlight  
**1000 lm/ft**

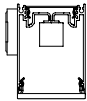

**PHOTOMETRIC CURVE**

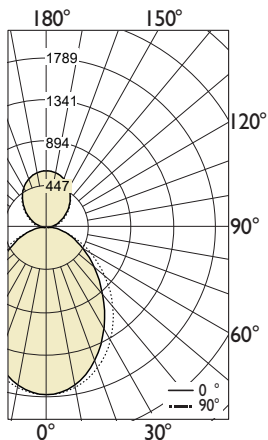

**Lumen/ft up: 1606 lm/ft**  
**Lumen/ft down: 4000 lm/ft**  
**Total Lumens: 5605 lm (for 4ft)**  
**Input Watts: 45.3 W**  
**Efficacy: 31 lm/W**

IES FILE: TB3DILED-400-1000-80-35-SO-0.25G-4.IES

TESTED ACCORDING TO IES LM-79-2008

**CANDELA DISTRIBUTION**

Vertical Angle	Horizontal Angles				
	0	22.5	45	67.5	90
0	1789	1789	1789	1789	1789
5	1777	1775	1773	1771	1771
15	1681	1673	1655	1637	1629
25	1498	1480	1439	1398	1380
35	1247	1223	1165	1109	1085
45	964	942	882	825	801
55	684	669	623	578	560
65	434	427	402	378	367
75	222	227	225	221	218
85	65	77	92	101	104
90	8	24	44	57	62
95	22	25	29	29	28
105	98	99	99	97	95
115	180	182	184	183	181
125	274	277	280	280	277
135	373	376	379	379	378
145	467	469	473	474	472
155	546	548	551	551	550
165	602	603	604	604	603
175	630	630	630	630	629
180	632	632	632	632	632

**ZONAL LUMENS**

Zone	Lumens
0	
0-10	168
10-20	465
20-30	661
30-40	729
40-50	682
50-60	559
60-70	400
70-80	238
80-90	99
90	
90-100	33
100-110	99
110-120	175
120-130	243
130-140	285
140-150	290
150-160	250
160-170	169
170-180	60
180	

**LUMINANCE DATA (cd/m²)**

Vertical Angle	Horizontal Angles		
	0	45	90
45	11999	10972	9972
55	10496	9550	8596
65	9031	8372	7649
75	7556	7654	7414
85	6520	9281	10500

**i** All IES files are available for download at: [www.axislighting.com](http://www.axislighting.com)

● **PHOTOMETRIC DATA**

**0.25G 0.25 Glo Lens - Up**  
**0.25G 0.25 Glo Lens - Down**

Uplight  
**1100 lm/ft**  
Downlight  
**400 lm/ft**

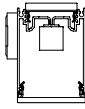

**PHOTOMETRIC CURVE**

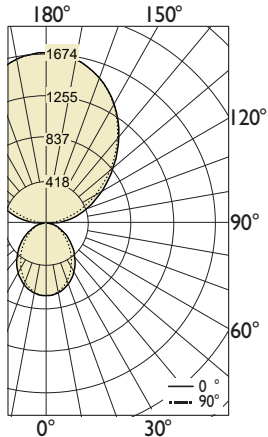

**Lumen/ft up: 4402 lm/ft**  
**Lumen/ft down: 1609 lm/ft**  
**Total Lumens: 6010 lm (for 4ft)**  
**Input Watts: 45.9 W**  
**Efficacy: 32.8 lm/W**

IES FILE: TB3DILED-1100-400-80-35-0.25G-0.25G-4.IES

TESTED ACCORDING TO IES LM-79-2008

**CANDELA DISTRIBUTION**

Vertical Angle	Horizontal Angles				
	0	22.5	45	67.5	90
0	715	715	715	715	715
5	711	710	709	709	708
15	672	669	662	655	652
25	599	592	575	559	552
35	499	489	466	443	434
45	386	377	353	330	321
55	274	267	249	231	224
65	174	171	161	151	147
75	89	91	90	88	87
85	26	31	37	41	42
90	113	108	86	56	34
95	180	168	134	95	67
105	348	335	297	258	234
115	535	525	497	473	451
125	751	747	733	716	700
135	992	992	986	974	965
145	1235	1235	1230	1224	1222
155	1441	1441	1438	1437	1437
165	1588	1588	1587	1587	1587
175	1664	1665	1664	1663	1663
180	1674	1674	1674	1674	1674

**ZONAL LUMENS**

Zone	Lumens
0	
0-10	67
10-20	186
20-30	265
30-40	291
40-50	273
50-60	223
60-70	160
70-80	95
80-90	49
90	
90-100	147
100-110	314
110-120	493
120-130	654
130-140	758
140-150	768
150-160	662
160-170	447
170-180	158
180	

**LUMINANCE DATA (cd/m²)**

Vertical Angle	Horizontal Angles		
	0	45	90
45	4800	4389	3989
55	4198	3820	3439
65	3612	3349	3060
75	3022	3062	2966
85	2608	3712	4200

**SO Spotless Lens - Up**  
**0.25G 0.25 Glo Lens - Down**

Uplight  
**1100 lm/ft**  
Downlight  
**400 lm/ft**

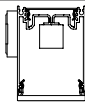

**PHOTOMETRIC CURVE**

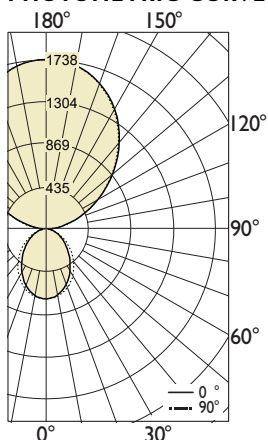

**Lumen/ft up: 4402 lm/ft**  
**Lumen/ft down: 1600 lm/ft**  
**Total Lumens: 6003 lm (for 4ft)**  
**Input Watts: 45.7 W**  
**Efficacy: 32.8 lm/W**

IES FILE: TB3DILED-1100-400-80-35-SO-0.25G-4.IES

TESTED ACCORDING TO IES LM-79-2008

**CANDELA DISTRIBUTION**

Vertical Angle	Horizontal Angles				
	0	22.5	45	67.5	90
0	715	715	715	715	715
5	711	710	709	709	708
15	672	669	662	655	652
25	599	592	575	559	552
35	499	489	466	443	434
45	386	377	353	330	321
55	274	267	249	231	224
65	174	171	161	151	147
75	89	91	90	88	87
85	26	31	37	41	42
90	4	11	19	24	29
95	60	69	81	80	77
105	268	272	273	267	261
115	496	501	506	504	497
125	753	763	769	770	761
135	1024	1033	1043	1044	1038
145	1283	1291	1300	1303	1298
155	1500	1508	1514	1516	1513
165	1655	1658	1661	1661	1659
175	1731	1733	1733	1731	1730
180	1738	1738	1738	1738	1738

**ZONAL LUMENS**

Zone	Lumens
0	
0-10	67
10-20	186
20-30	265
30-40	291
40-50	273
50-60	223
60-70	160
70-80	95
80-90	40
90	
90-100	78
100-110	273
110-120	482
120-130	667
130-140	785
140-150	798
150-160	689
160-170	465
170-180	164
180	

**LUMINANCE DATA (cd/m²)**

Vertical Angle	Horizontal Angles		
	0	45	90
45	4800	4389	3989
55	4198	3820	3439
65	3612	3349	3060
75	3022	3062	2966
85	2608	3712	4200

**i** All IES files are available for download at: [www.axislighting.com](http://www.axislighting.com)



● **PHOTOMETRIC DATA**

**0.25G 0.25 Glo Lens - Up**  
**0.25G 0.25 Glo Lens - Down**

Uplight  
**1100 lm/ft**  
Downlight  
**1000 lm/ft**

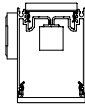

**PHOTOMETRIC CURVE**

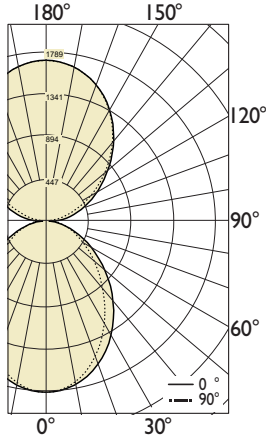

**Lumen/ft up: 4405 lm/ft**  
**Lumen/ft down: 4009 lm/ft**  
**Total Lumens: 8414 lm (for 4ft)**  
**Input Watts: 66 W**  
**Efficacy: 31.8 lm/W**

IES FILE: TB3DILED-1100-1000-80-35-0.25G-0.25G-4.IES

TESTED ACCORDING TO IES LM-79-2008

**CANDELA DISTRIBUTION**

Vertical Angle	Horizontal Angles				
	0	22.5	45	67.5	90
0	1789	1789	1789	1789	1789
5	1777	1775	1773	1771	1771
15	1681	1673	1655	1637	1629
25	1498	1480	1439	1398	1380
35	1247	1223	1165	1109	1085
45	964	942	882	825	801
55	684	669	623	578	560
65	434	427	402	378	367
75	222	227	225	221	218
85	65	77	92	101	104
90	117	123	112	90	71
95	180	168	134	95	67
105	348	335	297	258	234
115	535	525	497	473	451
125	751	747	733	716	700
135	992	992	986	974	965
145	1235	1235	1230	1224	1222
155	1441	1441	1438	1437	1437
165	1588	1588	1587	1587	1587
175	1664	1665	1664	1663	1663
180	1674	1674	1674	1674	1674

**ZONAL LUMENS**

Zone	Lumens
0	
0-10	168
10-20	465
20-30	661
30-40	729
40-50	682
50-60	559
60-70	400
70-80	238
80-90	108
90	
90-100	150
100-110	314
110-120	493
120-130	654
130-140	758
140-150	768
150-160	662
160-170	447
170-180	158
180	

**LUMINANCE DATA (cd/m²)**

Vertical Angle	Horizontal Angles		
	0	45	90
45	11999	10972	9972
55	10496	9550	8596
65	9031	8372	7649
75	7556	7654	7414
85	6520	9281	10500

**SO Spotless Lens - Up**  
**0.25G 0.25 Glo Lens - Down**

Uplight  
**1100 lm/ft**  
Downlight  
**1000 lm/ft**

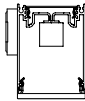

**PHOTOMETRIC CURVE**

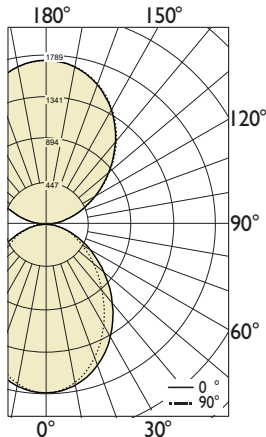

**Lumen/ft up: 4402 lm/ft**  
**Lumen/ft down: 3997 lm/ft**  
**Total Lumens: 8399 lm (for 4ft)**  
**Input Watts: 65.8 W**  
**Efficacy: 32 lm/W**

IES FILE: TB3DILED-1100-1000-80-35-SO-0.25G-4.IES

TESTED ACCORDING TO IES LM-79-2008

**CANDELA DISTRIBUTION**

Vertical Angle	Horizontal Angles				
	0	22.5	45	67.5	90
0	1789	1789	1789	1789	1789
5	1777	1775	1773	1771	1771
15	1681	1673	1655	1637	1629
25	1498	1480	1439	1398	1380
35	1247	1223	1165	1109	1085
45	964	942	882	825	801
55	684	669	623	578	560
65	434	427	402	378	367
75	222	227	225	221	218
85	65	77	92	101	104
90	3	10	18	23	26
95	60	69	81	80	77
105	268	272	273	267	261
115	496	501	506	504	497
125	753	763	769	770	761
135	1024	1033	1043	1044	1038
145	1283	1291	1300	1303	1298
155	1500	1508	1514	1516	1513
165	1655	1658	1661	1661	1659
175	1731	1733	1733	1731	1730
180	1738	1738	1738	1738	1738

**ZONAL LUMENS**

Zone	Lumens
0	
0-10	168
10-20	465
20-30	661
30-40	729
40-50	682
50-60	559
60-70	400
70-80	238
80-90	96
90	
90-100	78
100-110	273
110-120	482
120-130	667
130-140	785
140-150	798
150-160	689
160-170	465
170-180	164
180	

**LUMINANCE DATA (cd/m²)**

Vertical Angle	Horizontal Angles		
	0	45	90
45	11999	10972	9972
55	10496	9550	8596
65	9031	8372	7649
75	7556	7654	7414
85	6520	9281	10500

**i** All IES files are available for download at: [www.axislighting.com](http://www.axislighting.com)