

Flush Spotless Lens - down
Glo Lens - up

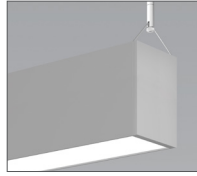

StepLens 1.25 - down



SurroundLite up
Flush Spotless lens - down

Project _____

Type _____

Notes _____

PERFORMANCE PER LINEAR FOOT AT 3500K

NOMINAL LUMEN OUTPUT		INPUT WATTS*	EFFICACY	SHIELDING I/D
UPLIGHT	DOWNLIGHT			
400 lm/ft	400 lm/ft	6.78 W/ft	118 lm/W	0.25G/0.25G
400 lm/ft	400 lm/ft	7.13 W/ft	112 lm/W	SO/0.25G
400 lm/ft	1000 lm/ft	12.04 W/ft	116 lm/ft	0.25G/0.25G
400 lm/ft	1000 lm/ft	12.4 W/ft	113 lm/ft	SO/0.25G
1100 lm/ft	400 lm/ft	12.5 W/ft	131 lm/W	0.25G/0.25G
1100 lm/ft	400 lm/ft	13.43 W/ft	112 lm/W	SO/0.25G
1100 lm/ft	1100 lm/ft	17.48 W/ft	119 lm/W	0.25G/0.25G
1100 lm/ft	1100 lm/ft	18.7 W/ft	112 lm/W	SO/0.25G

Please consult factory for custom lumen output and wattage.

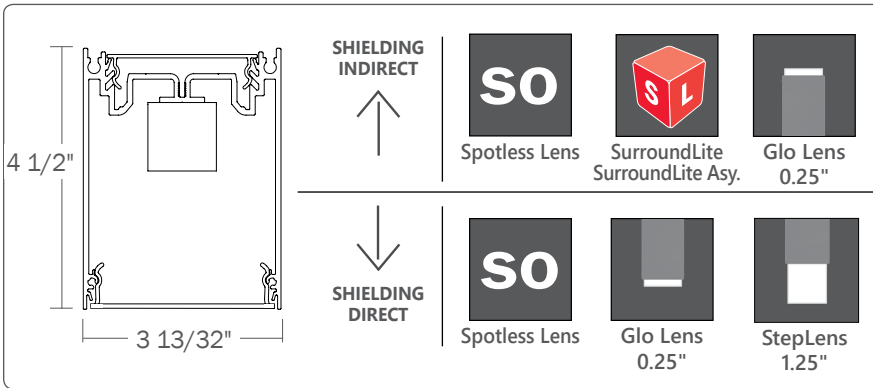

Ordering Guide

TB3DILED		NOM. LUM/FT UP		NOM. LUM/FT DOWN		CRI		COLOR TEMP.		SHIELDING INDIRECT		SHIELDING DIRECT	
TB3DILED	Twin BEAM3 - Pendant Direct/Indirect LED	400	400 lm/ft - min.	400	400 lm/ft - min.	80	80 CRI	27	2700 K	SO	spotless lens	SO	spotless lens
		1100	1100 lm/ft - max.	1000	1000 lm/ft - max.	90	90 CRI	30	3000 K	SL	surroundlite	0.25G	0.25" Glo lens
								35	3500 K	SLA	surroundlite asymmetric	1.25M	StepLens , lum. end cap
								40	4000 K	0.25G	0.25" Glo lens		
		Outputs between listed min and max are available. Consult factory for outputs outside of the listed range.		Outputs between listed min and max are available. Consult factory for outputs outside of the listed range.				Consult Axitune spec sheet for Axis color technology options		Choose only one of the options above		Choose only one of the options above; SurroundLite not available with direct	

LENGTH (FT)	MR (OPTIONAL)	FINISH	VOLTAGE	DRIVER	CIRCUITS
2 2'	DMLED(#) downlight modle LED	AP aluminum paint	120 120 V	DP dimming (0-10V) 1%	1 1 circuit
3 3'		W white	277 277 V	LT Lutron ⁽¹⁾	2 2 circuits
4 4'		BLK black	347 347 V	BI bi-level dimming	+E(#) emergency circuit ⁽³⁾
5 5'		C custom	UNV universal	O other ⁽²⁾	+NL(#) night light circuit ⁽³⁾
8 8'					+GTD(#) generator transfer device ⁽³⁾
12 12'					+M MR
S# System Run *					
* SurroundLite available in 1' increments	Add 6" per lamp, Specify quantity Separate circuits included Requires 120V or 277V			(1) Specify system (2) Please consult factory; see page 2 Consult Axitune spec sheet for Axis color driver options	(3) Specify quantity

MOUNTING/SUSPENSION	BATTERY (OPTIONAL)	OTHER (OPTIONAL)	IC CONTROLS (OPTIONAL)	CUSTOM (OPTIONAL)
CA(#) drywall+cable length (36" std.)	B# battery pack (integral)	F fuse ⁽⁴⁾	DS# daylight sensor	C custom
CT9(#) TB/TG 9/16+cable length (36" std.)			OS# occupancy sensor	
CT15(#) TB/TG15/16+cable length (36" std.)			DOS# daylight & occupancy sensor	
CTS(#) ST+cable length (36" std.)			EN# Enlighted integral ⁽⁵⁾	
SA(#) drywall+stem length >48" (18" std.)			ENR# Enlighted remote ⁽⁵⁾	
White canopy standard	Minimum 5ft; Not available with 347V Please consult factory	(4) Requires 120V or 277V	WC# wireless control dimming	Please specify
			(5) Please consult factory Specify quantity. Requires 8" blank. See integrated controls guide for more details.	

● **CONSTRUCTION**

Housing	Extruded aluminum (0.075" nominal) Up to 70% recycled content
End Cap	Cast aluminum
Interior Brackets	Die formed sheet steel (20 gauge)
Reflectors	White powder coated sheet steel (22 gauge)
Lenses	Extruded acrylic (0.070" nominal)
Hanger	Die cast aluminum
Suspension	Sliding aircraft cable along product length

● **ELECTRICAL**

Lutron driver*	LDE1 - EcoSystem H-Series (1%) LDE5 - EcoSystem 5-Series (5%) LTE - Hi-Lume® A-series 2Wires Forward Phase (1%) <small>*Consult factory</small>
Other drivers	DALI - Digital Addressable Lighting Interface DMX - Digital Multiplex LV - line voltage - Advance Mark 10 Xitanium SR - For wireless sensor POE (Power over Ethernet) - Low Voltage Lighting System.
Emergency	Integral emergency battery pack or emergency circuit optional.
Input Voltage	120V, 277V, 347V, UNV.

i Incorporating these components may have limitations or affect the length of the luminaire. Please contact factory for more details.

● **LED SYSTEM**

CRI	Minimum 80 or 90 color rendering index.
CCT	Choice of 2700K, 3000K, 3500K and 4000K color temperature with a great color consistency (within 3-step MacAdam ellipse). Both within fixture and fixture to fixture.
LED life	Minimum 50,000h with 85% of lumen maintenance in 25°C ambient temperature, in compliance with IES LM-80 testing measurements.
Thermal Management	Aluminum housing acting as the heat sink to maximize life.
Environment	Dry and damp rated in operating ambient temperatures of 0-40°C (32-104F).

● **OPTICS**



50 Spotless lens

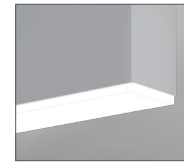

0.25G Glo lens

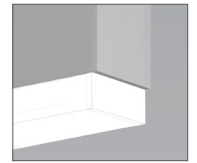

1.25M 1.25" StepLens

SPOTLESS LENS

Frosted acrylic snap-in micro lens

GLO LENS

0.25" frosted acrylic drop lens. Patented design.

STEPLENS

1.25" StepLens, illuminated end cap.

● **SYSTEM (S#)**

TWIN BEAM3 SurroundLite linear systems, with the use of a strong profile, allow for a nearly hair thin connection system of continuous runs. Lengths of 4', 8', 12' as well as custom lengths are available. Runs of TWIN BEAM3 SurroundLite that are greater than 12' in length are designated as systems (S#). This means that the run is comprised of a combination of 4', 8' and/or 12' sections to be assembled on site using our joining system. System runs with SurroundLite available in 1' increments only. For more information on systems and joining, please refer to the BEAM3 installation sheets available for download at www.axislighting.com.

● **WARRANTY**

Axis Lighting will warrant defective LEDs, boards, and drivers for 5 years from date of purchase. Warranty is valid if luminaire is installed and used according to specifications. If defective, Axis will send replacement boards or drivers at no cost along with detailed replacement instructions and instructions on how to return defective components to Axis.

● **JOINERS**

TWIN BEAM3 SurroundLite luminaires feature the joining mechanism shown below. This mechanism joins and aligns multiple luminaires to create long continuous runs of light.

NOTE: Mount each system segment individually.

Do not assemble system prior to mounting

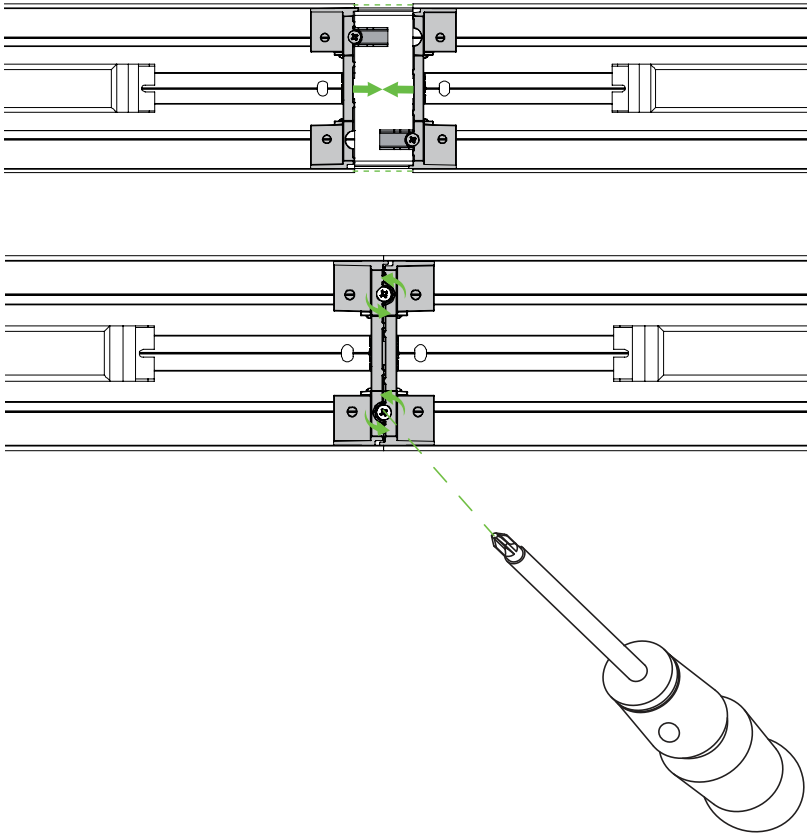

● **SECTION VIEWS**

0.25G 0.25" Glo lens - Indirect

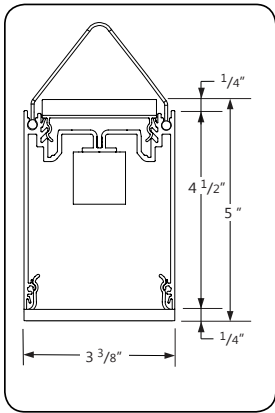

0.25G 0.25" Glo lens - Direct

SL SurroundLite - Indirect

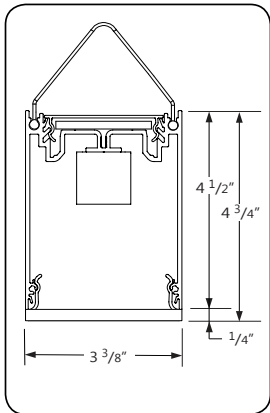

0.25G 0.25" Glo lens - Direct

SO Spotless lens - Indirect

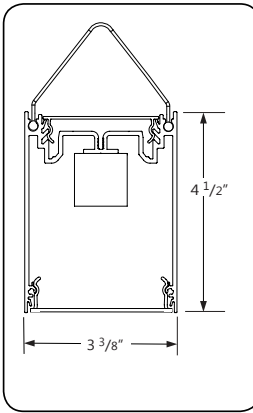

SO Spotless lens - Direct

SL SurroundLite - Indirect

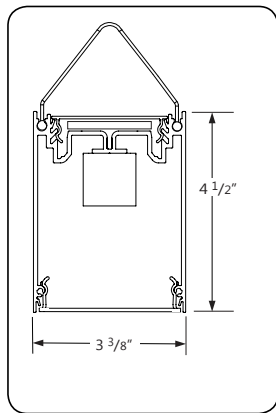

SO Spotless lens - Direct

SO Spotless lens - Indirect

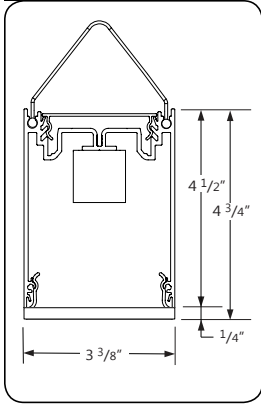

0.25G 0.25" Glo lens - Direct

SL SurroundLite - Indirect

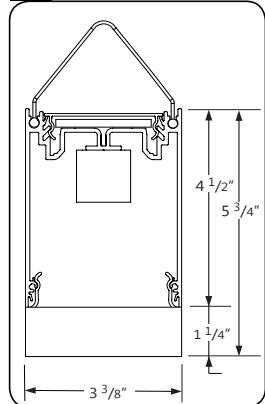

1.25M 1.25" StepLens - Direct

SO Spotless lens - Indirect

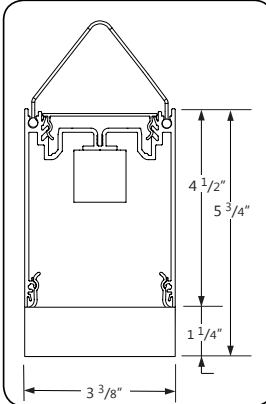

1.25M 1.25" StepLens - Direct

0.25G 0.25" Glo lens - Indirect

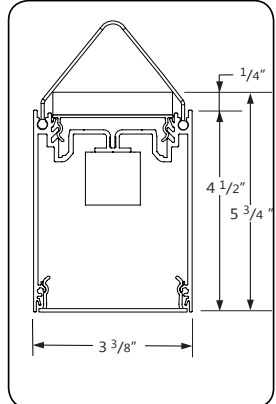

SO Spotless lens - Direct

SLA SurroundLite Asymmetric - Indirect

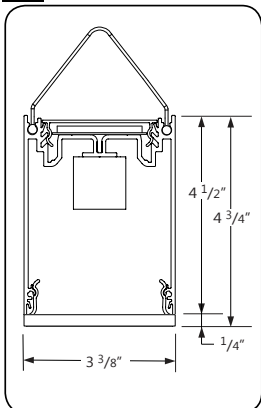

0.25G 0.25" Glo lens - Direct

SLA SurroundLite Asymmetric - Indirect

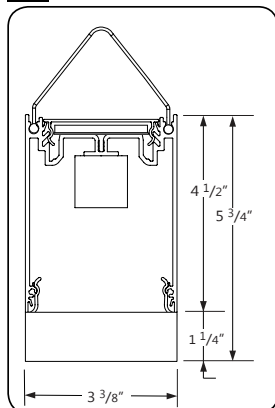

1.25M 1.25" StepLens - Direct

SLA SurroundLite Asymmetric - Indirect

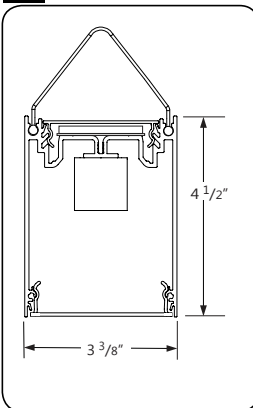

SO Spotless lens - Direct

0.25G 0.25" Glo lens - Indirect

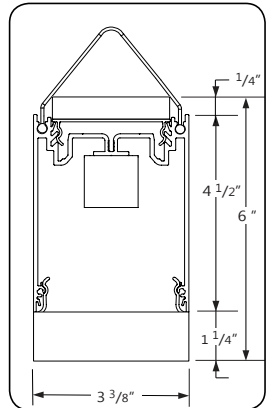

1.25M 1.25" StepLens - Direct

● **MOUNTING OPTIONS**

CT TILE CEILING - ON GRID

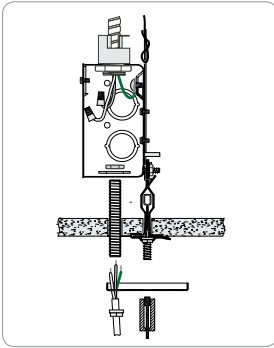

Power feed

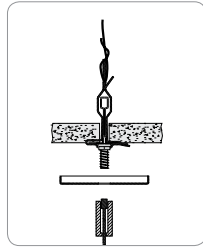

Non power feed

CA DRYWALL CEILING

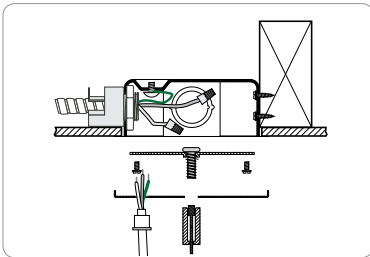

Power feed

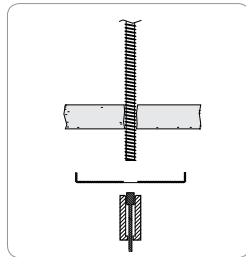

Non power feed

SA STEM MOUNT IN DRYWALL CEILING

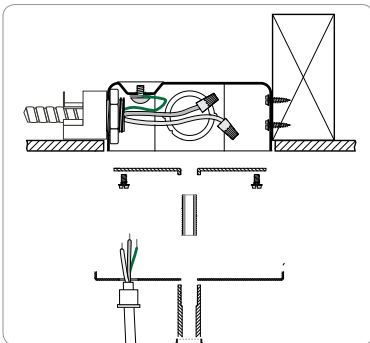

Power feed

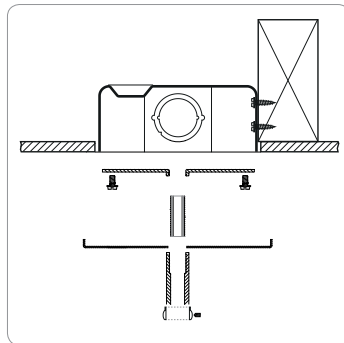

Non power feed

● **OTHER MOUNTING OPTIONS**

TWIN BEAM3 SurroundLite is also available with wall mounted option.

i Specification sheets and installation sheets for all mountings for TWIN BEAM3 SurroundLite luminaires are available for download at www.axislighting.com

● **OWNLIGHT MODLE LED**

Blank DMLED Quantity

Extruded aluminum (0.075" nominal)
1.4" diameter
For every 4' section, there may be up to a maximum of 4 x DMLED lamps.
Each DMLED lamp is placed centered on a blank section 6" in length.

Spacing

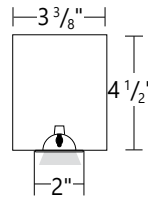

For a series of DM's within a given section length, they will be spaced evenly on a longer blank section.
The directed light of DMLED lamps are fixed downward.
Custom spacing may be available on special request.

Between sections

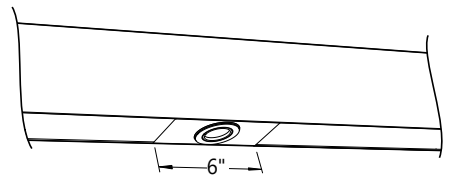

At luminaire ends

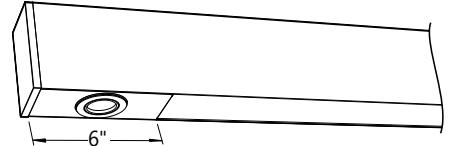

Several in a long blank section

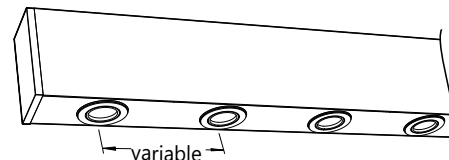

Beam Angle	45 nominal degrees
Input Watts	3W
Nominal Lumens	50 lumens
Efficacy	17 lumens per watt
Color Rendering Index (CRI)	80
Life	25,000 hours at L ₇₀
Correlated color temperature (CCT)	2700K

i More options are available upon request. Please consult factory.

● **FINISH**

Aluminium paint, powder coated and custom finishes are also available.

● **APPROVALS**

Certified to UL and CSA standards 
Meets NYC requirements
Meets ADA requirements.
Suitable for damp locations.

● **PHOTOMETRIC DATA**

0.25G 0.25 Glo Lens - Up
0.25G 0.25 Glo Lens - Down

Uplight
400 lm/ft
 Downlight
400 lm/ft

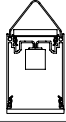

PHOTOMETRIC CURVE

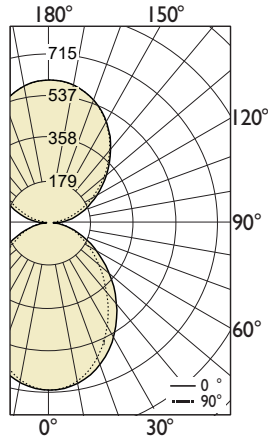

Lumen/ft up: 1601 lm/ft
Lumen/ft down: 1603 lm/ft
Total Lumens: 3202 lm (for 4ft)
Input Watts: 25.2 W
Efficacy: 31.8 lm/W

IES FILE: TB3DILED-400-400-80-35-0.25G-0.25G-4.IES

TESTED ACCORDING TO IES LM-79-2008

CANDELA DISTRIBUTION

Vertical Angle	Horizontal Angles				
	0	22.5	45	67.5	90
0	715	715	715	715	715
5	711	710	709	709	708
15	672	669	662	655	652
25	599	592	575	559	552
35	499	489	466	443	434
45	386	377	353	330	321
55	274	267	249	231	224
65	174	171	161	151	147
75	89	91	90	88	87
85	26	31	37	41	42
90	43	46	42	35	28
95	66	61	49	35	24
105	127	122	108	94	85
115	195	191	181	172	164
125	273	272	267	260	254
135	361	361	359	354	351
145	449	449	447	445	444
155	524	524	523	523	523
165	577	577	577	577	577
175	605	605	605	605	605
180	609	609	609	609	609

ZONAL LUMENS

Zone	Lumens
0	
0-10	67
10-20	186
20-30	265
30-40	291
40-50	273
50-60	223
60-70	160
70-80	95
80-90	43
90	
90-100	55
100-110	114
110-120	179
120-130	238
130-140	276
140-150	279
150-160	241
160-170	163
170-180	57
180	

LUMINANCE DATA (cd/m²)

Vertical Angle	Horizontal Angles		
	0	45	90
45	4800	4389	3989
55	4198	3820	3439
65	3612	3349	3060
75	3022	3062	2966
85	2608	3712	4200

SO Spotless Lens - Up
0.25G 0.25 Glo Lens - Down

Uplight
400 lm/ft
 Downlight
400 lm/ft

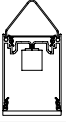

PHOTOMETRIC CURVE

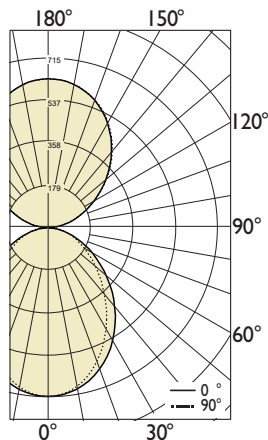

Lumen/ft up: 1602 lm/ft
Lumen/ft down: 1600 lm/ft
Total Lumens: 3202 lm (for 4ft)
Input Watts: 25.2 W
Efficacy: 31.8 lm/W

IES FILE: TB3DILED-400-400-80-35-SO-0.25G-4.IES

TESTED ACCORDING TO IES LM-79-2008

CANDELA DISTRIBUTION

Vertical Angle	Horizontal Angles				
	0	22.5	45	67.5	90
0	715	715	715	715	715
5	711	710	709	709	708
15	672	669	662	655	652
25	599	592	575	559	552
35	499	489	466	443	434
45	386	377	353	330	321
55	274	267	249	231	224
65	174	171	161	151	147
75	89	91	90	88	87
85	26	31	37	41	42
90	3	10	18	23	26
95	22	25	29	29	28
105	98	99	99	97	95
115	180	182	184	183	181
125	274	277	280	280	277
135	373	376	379	379	378
145	467	469	473	474	472
155	546	548	551	551	550
165	602	603	604	604	603
175	630	630	630	630	629
180	632	632	632	632	632

ZONAL LUMENS

Zone	Lumens
0	
0-10	67
10-20	186
20-30	265
30-40	291
40-50	273
50-60	223
60-70	160
70-80	95
80-90	40
90	
90-100	30
100-110	99
110-120	175
120-130	243
130-140	285
140-150	290
150-160	250
160-170	169
170-180	60
180	

LUMINANCE DATA (cd/m²)

Vertical Angle	Horizontal Angles		
	0	45	90
45	4800	4389	3989
55	4198	3820	3439
65	3612	3349	3060
75	3022	3062	2966
85	2608	3712	4200

i All IES files are available for download at: www.axislighting.com

● **PHOTOMETRIC DATA**

SL SurroundLite - Up
SO Spotless Lens - Down

Uplight
400 lm/ft
Downlight
400 lm/ft

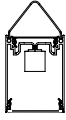

PHOTOMETRIC CURVE

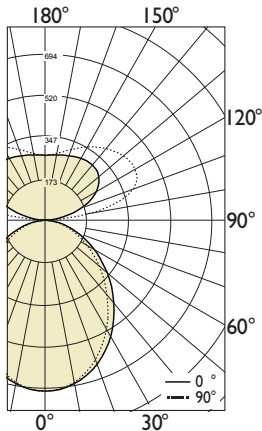

Lumen/ft up: 400 lm/ft
Lumen/ft down: 400 lm/ft
Total Lumens: 3194 lm (for 4ft)
Input Watts: 29.06 W
Efficacy: 110 lm/W

IES FILE: TB3DILED-400-400-80-35-SL-SO-4.IES

TESTED ACCORDING TO IES LM-79-2008

CANDELA DISTRIBUTION

Vertical Angle	Horizontal Angles				
	0	22.5	45	67.5	90
0	694	694	694	694	694
5	689	689	688	688	688
15	652	650	645	641	639
25	582	578	568	558	553
35	487	482	467	453	446
45	381	376	361	344	336
55	276	272	258	243	237
65	178	176	166	155	151
75	94	93	88	83	80
85	27	26	25	23	22
90	1	2	2	2	2
95	24	47	50	60	63
105	119	148	205	286	323
115	209	234	286	367	411
125	267	289	328	388	419
135	292	308	340	378	397
145	294	304	328	352	363
155	285	290	304	318	324
165	274	276	280	286	289
175	267	266	267	267	268
180	264	264	264	264	264

ZONAL LUMENS

Zone	Lumens
0	
0-10	65
10-20	182
20-30	261
30-40	292
40-50	278
50-60	230
60-70	164
70-80	93
80-90	28
90	
90-100	64
100-110	223
110-120	295
120-130	301
130-140	265
140-150	206
150-160	141
160-170	80
170-180	26
180	

LUMINANCE DATA (cd/m²)

Vertical Angle	Horizontal Angles		
	0	45	90
45	7365	6963	6496
55	6567	6134	5630
65	5763	5361	4872
75	4934	4633	4229
85	4206	3865	3518

0.25G 0.25 Glo Lens - Up
0.25G 0.25 Glo Lens - Down

Uplight
400 lm/ft
Downlight
1000 lm/ft

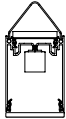

PHOTOMETRIC CURVE

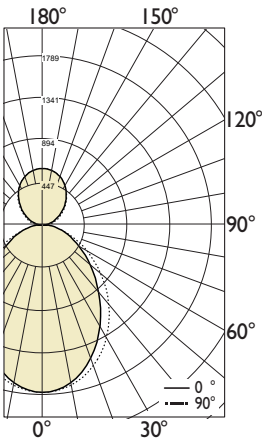

Lumen/ft up: 1605 lm/ft
Lumen/ft down: 4003 lm/ft
Total Lumens: 5608 lm (for 4ft)
Input Watts: 47.38 W
Efficacy: 29.5 lm/W

IES FILE: TB3DILED-400-1000-80-35-0.25G-0.25G-4.IES

TESTED ACCORDING TO IES LM-79-2008

CANDELA DISTRIBUTION

Vertical Angle	Horizontal Angles				
	0	22.5	45	67.5	90
0	1789	1789	1789	1789	1789
5	1777	1775	1773	1771	1771
15	1681	1673	1655	1637	1629
25	1498	1480	1439	1398	1380
35	1247	1223	1165	1109	1085
45	964	942	882	825	801
55	684	669	623	578	560
65	434	427	402	378	367
75	222	227	225	221	218
85	65	77	92	101	104
90	48	60	68	69	64
95	66	61	49	35	24
105	127	122	108	94	85
115	195	191	181	172	164
125	273	272	267	260	254
135	361	361	359	354	351
145	449	449	447	445	444
155	524	524	523	523	523
165	577	577	577	577	577
175	605	605	605	605	605
180	609	609	609	609	609

ZONAL LUMENS

Zone	Lumens
0	
0-10	168
10-20	465
20-30	661
30-40	729
40-50	682
50-60	559
60-70	400
70-80	238
80-90	102
90	
90-100	58
100-110	114
110-120	179
120-130	238
130-140	276
140-150	279
150-160	241
160-170	163
170-180	57
180	

LUMINANCE DATA (cd/m²)

Vertical Angle	Horizontal Angles		
	0	45	90
45	11999	10972	9972
55	10496	9550	8596
65	9031	8372	7649
75	7556	7654	7414
85	6520	9281	10500

i All IES files are available for download at: www.axislighting.com

● **PHOTOMETRIC DATA**

SO Spotless Lens - Up
0.25G 0.25 Glo Lens - Down

Uplight
400 lm/ft
Downlight
1000 lm/ft

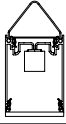

PHOTOMETRIC CURVE

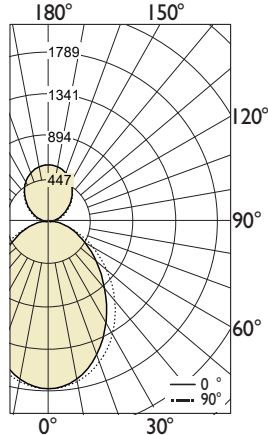

Lumen/ft up: 1606 lm/ft
Lumen/ft down: 4000 lm/ft
Total Lumens: 5605 lm (for 4ft)
Input Watts: 45.3 W
Efficacy: 31 lm/W

IES FILE: TB3DILED-400-1000-80-35-SO-0.25G-4.IES

TESTED ACCORDING TO IES LM-79-2008

CANDELA DISTRIBUTION

Vertical Angle	Horizontal Angles				
	0	22.5	45	67.5	90
0	1789	1789	1789	1789	1789
5	1777	1775	1773	1771	1771
15	1681	1673	1655	1637	1629
25	1498	1480	1439	1398	1380
35	1247	1223	1165	1109	1085
45	964	942	882	825	801
55	684	669	623	578	560
65	434	427	402	378	367
75	222	227	225	221	218
85	65	77	92	101	104
90	8	24	44	57	62
95	22	25	29	29	28
105	98	99	99	97	95
115	180	182	184	183	181
125	274	277	280	280	277
135	373	376	379	379	378
145	467	469	473	474	472
155	546	548	551	551	550
165	602	603	604	604	603
175	630	630	630	630	629
180	632	632	632	632	632

ZONAL LUMENS

Zone	Lumens
0	
0-10	168
10-20	465
20-30	661
30-40	729
40-50	682
50-60	559
60-70	400
70-80	238
80-90	99
90	
90-100	33
100-110	99
110-120	175
120-130	243
130-140	285
140-150	290
150-160	250
160-170	169
170-180	60
180	

LUMINANCE DATA (cd/m²)

Vertical Angle	Horizontal Angles		
	0	45	90
45	11999	10972	9972
55	10496	9550	8596
65	9031	8372	7649
75	7556	7654	7414
85	6520	9281	10500

SL SurroundLite - Up
SO Spotless Lens - Down

Uplight
400 lm/ft
Downlight
1000 lm/ft

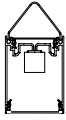

PHOTOMETRIC CURVE

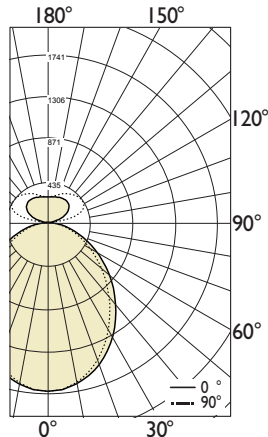

Lumen/ft up: 400 lm/ft
Lumen/ft down: 1000 lm/ft
Total Lumens: 5603 lm (for 4ft)
Input Watts: 50.9 W
Efficacy: 110 lm/W

IES FILE: TB3DILED-400-1000-80-35-SL-SO-4.IES

TESTED ACCORDING TO IES LM-79-2008

CANDELA DISTRIBUTION

Vertical Angle	Horizontal Angles				
	0	22.5	45	67.5	90
0	1741	1741	1741	1741	1741
5	1730	1729	1728	1726	1727
15	1636	1631	1620	1610	1605
25	1460	1451	1426	1400	1389
35	1222	1210	1173	1137	1119
45	957	945	905	863	844
55	692	683	647	610	594
65	448	442	416	390	379
75	235	233	220	207	201
85	67	66	62	58	56
90	3	5	6	6	6
95	24	47	50	60	63
105	119	148	205	286	323
115	209	234	286	367	411
125	267	289	328	388	419
135	292	308	340	378	397
145	294	304	328	352	363
155	285	290	304	318	324
165	274	276	280	286	289
175	267	266	267	267	268
180	264	264	264	264	264

ZONAL LUMENS

Zone	Lumens
0	
0-10	163
10-20	456
20-30	655
30-40	733
40-50	697
50-60	579
60-70	413
70-80	234
80-90	72
90	
90-100	64
100-110	223
110-120	295
120-130	301
130-140	265
140-150	206
150-160	141
160-170	80
170-180	26
180	

LUMINANCE DATA (cd/m²)

Vertical Angle	Horizontal Angles		
	0	45	90
45	18489	17479	16308
55	16486	15399	14134
65	14466	13457	12230
75	12386	11631	10617
85	10557	9703	8832

i All IES files are available for download at: www.axislighting.com

● **PHOTOMETRIC DATA**

0.25G 0.25 Glo Lens - Up
0.25G 0.25 Glo Lens - Down

Uplight
1100 lm/ft
Downlight
400 lm/ft

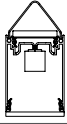

PHOTOMETRIC CURVE

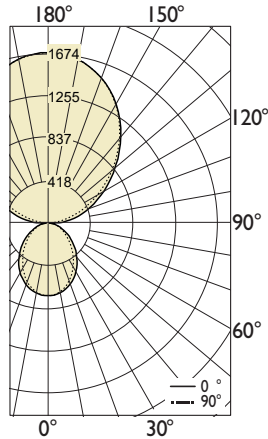

Lumen/ft up: 4402 lm/ft
Lumen/ft down: 1609 lm/ft
Total Lumens: 6010 lm (for 4ft)
Input Watts: 45.9 W
Efficacy: 32.8 lm/W

IES FILE: TB3DILED-1100-400-80-35-0.25G-0.25G-4.IES

TESTED ACCORDING TO IES LM-79-2008

CANDELA DISTRIBUTION

Vertical Angle	Horizontal Angles				
	0	22.5	45	67.5	90
0	715	715	715	715	715
5	711	710	709	709	708
15	672	669	662	655	652
25	599	592	575	559	552
35	499	489	466	443	434
45	386	377	353	330	321
55	274	267	249	231	224
65	174	171	161	151	147
75	89	91	90	88	87
85	26	31	37	41	42
90	113	108	86	56	34
95	180	168	134	95	67
105	348	335	297	258	234
115	535	525	497	473	451
125	751	747	733	716	700
135	992	992	986	974	965
145	1235	1235	1230	1224	1222
155	1441	1441	1438	1437	1437
165	1588	1588	1587	1587	1587
175	1664	1665	1664	1663	1663
180	1674	1674	1674	1674	1674

ZONAL LUMENS

Zone	Lumens
0	
0-10	67
10-20	186
20-30	265
30-40	291
40-50	273
50-60	223
60-70	160
70-80	95
80-90	49
90	
90-100	147
100-110	314
110-120	493
120-130	654
130-140	758
140-150	768
150-160	662
160-170	447
170-180	158
180	

LUMINANCE DATA (cd/m²)

Vertical Angle	Horizontal Angles		
	0	45	90
45	4800	4389	3989
55	4198	3820	3439
65	3612	3349	3060
75	3022	3062	2966
85	2608	3712	4200

SO Spotless Lens - Up
0.25G 0.25 Glo Lens - Down

Uplight
1100 lm/ft
Downlight
400 lm/ft

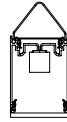

PHOTOMETRIC CURVE

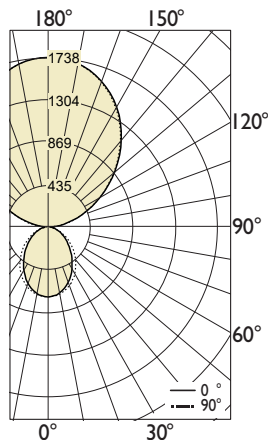

Lumen/ft up: 4402 lm/ft
Lumen/ft down: 1600 lm/ft
Total Lumens: 6003 lm (for 4ft)
Input Watts: 45.7 W
Efficacy: 32.8 lm/W

IES FILE: TB3DILED-1100-400-80-35-SO-0.25G-4.IES

TESTED ACCORDING TO IES LM-79-2008

CANDELA DISTRIBUTION

Vertical Angle	Horizontal Angles				
	0	22.5	45	67.5	90
0	715	715	715	715	715
5	711	710	709	709	708
15	672	669	662	655	652
25	599	592	575	559	552
35	499	489	466	443	434
45	386	377	353	330	321
55	274	267	249	231	224
65	174	171	161	151	147
75	89	91	90	88	87
85	26	31	37	41	42
90	4	11	19	24	29
95	60	69	81	80	77
105	268	272	273	267	261
115	496	501	506	504	497
125	753	763	769	770	761
135	1024	1033	1043	1044	1038
145	1283	1291	1300	1303	1298
155	1500	1508	1514	1516	1513
165	1655	1658	1661	1661	1659
175	1731	1733	1733	1731	1730
180	1738	1738	1738	1738	1738

ZONAL LUMENS

Zone	Lumens
0	
0-10	67
10-20	186
20-30	265
30-40	291
40-50	273
50-60	223
60-70	160
70-80	95
80-90	40
90	
90-100	78
100-110	273
110-120	482
120-130	667
130-140	785
140-150	798
150-160	689
160-170	465
170-180	164
180	

LUMINANCE DATA (cd/m²)

Vertical Angle	Horizontal Angles		
	0	45	90
45	4800	4389	3989
55	4198	3820	3439
65	3612	3349	3060
75	3022	3062	2966
85	2608	3712	4200

i All IES files are available for download at: www.axislighting.com

● **PHOTOMETRIC DATA**

SL SurroundLite - Up
SO Spotless Lens - Down

Uplight
1100 lm/ft
Downlight
400 lm/ft



PHOTOMETRIC CURVE

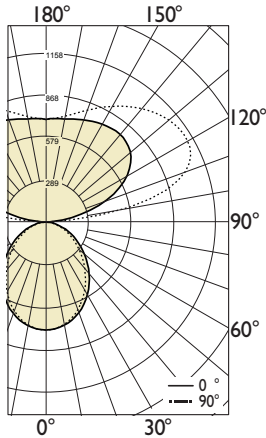

Lumen/ft up: 1100 lm/ft
Lumen/ft down: 400 lm/ft
Total Lumens: 5995 lm (for 4ft)
Input Watts: 54.5 W
Efficacy: 110 lm/W

IES FILE: TB3DILED-1100-400-80-35-SL-SO-4.IES

TESTED ACCORDING TO IES LM-79-2008

CANDELA DISTRIBUTION					
Vertical Angle	Horizontal Angles				
	0	22.5	45	67.5	90
0	694	694	694	694	694
5	689	689	688	688	688
15	652	650	645	641	639
25	582	578	568	558	553
35	487	482	467	453	446
45	381	376	361	344	336
55	276	272	258	243	237
65	178	176	166	155	151
75	94	93	88	83	80
85	27	26	25	23	22
90	2	3	4	5	5
95	66	128	138	165	174
105	327	408	565	785	887
115	575	644	788	1010	1131
125	735	794	903	1066	1152
135	804	848	935	1041	1093
145	810	837	903	968	999
155	784	798	836	874	892
165	753	758	771	785	795
175	733	733	733	734	736
180	727	727	727	727	727

ZONAL LUMENS	
Zone	Lumens
0	
0-10	65
10-20	182
20-30	261
30-40	292
40-50	278
50-60	230
60-70	164
70-80	93
80-90	28
90	
90-100	175
100-110	613
110-120	811
120-130	827
130-140	728
140-150	567
150-160	388
160-170	220
170-180	70
180	

LUMINANCE DATA (cd/m ²)			
Vertical Angle	Horizontal Angles		
	0	45	90
45	6567	6134	5630
55	5763	5361	4872
65	4934	4633	4229
75	4206	3865	3518
85	6520	9281	10500

0.25G 0.25 Glo Lens - Up
0.25G 0.25 Glo Lens - Down

Uplight
1100 lm/ft
Downlight
1000 lm/ft

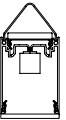

PHOTOMETRIC CURVE

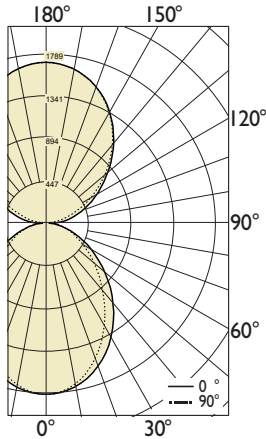

Lumen/ft up: 4405 lm/ft
Lumen/ft down: 4009 lm/ft
Total Lumens: 8414 lm (for 4ft)
Input Watts: 66 W
Efficacy: 31.8 lm/W

IES FILE: TB3DILED-1100-1000-80-35-0.25G-0.25G-4.IES

TESTED ACCORDING TO IES LM-79-2008

CANDELA DISTRIBUTION					
Vertical Angle	Horizontal Angles				
	0	22.5	45	67.5	90
0	1789	1789	1789	1789	1789
5	1777	1775	1773	1771	1771
15	1681	1673	1655	1637	1629
25	1498	1480	1439	1398	1380
35	1247	1223	1165	1109	1085
45	964	942	882	825	801
55	684	669	623	578	560
65	434	427	402	378	367
75	222	227	225	221	218
85	65	77	92	101	104
90	117	123	112	90	71
95	180	168	134	95	67
105	348	335	297	258	234
115	535	525	497	473	451
125	751	747	733	716	700
135	992	992	986	974	965
145	1235	1235	1230	1224	1222
155	1441	1441	1438	1437	1437
165	1588	1588	1587	1587	1587
175	1664	1665	1664	1663	1663
180	1674	1674	1674	1674	1674

ZONAL LUMENS	
Zone	Lumens
0	
0-10	168
10-20	465
20-30	661
30-40	729
40-50	682
50-60	559
60-70	400
70-80	238
80-90	108
90	
90-100	150
100-110	314
110-120	493
120-130	654
130-140	758
140-150	768
150-160	662
160-170	447
170-180	158
180	

LUMINANCE DATA (cd/m ²)			
Vertical Angle	Horizontal Angles		
	0	45	90
45	11999	10972	9972
55	10496	9550	8596
65	9031	8372	7649
75	7556	7654	7414
85	6520	9281	10500

i All IES files are available for download at: www.axislighting.com

● **PHOTOMETRIC DATA**

SO Spotless Lens - Up
0.25G 0.25 Glo Lens - Down

Uplight
1100 lm/ft
Downlight
1000 lm/ft

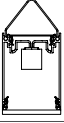

PHOTOMETRIC CURVE

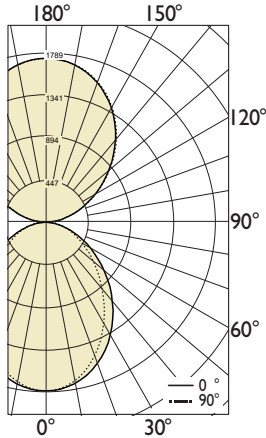

Lumen/ft up: 4402 lm/ft
Lumen/ft down: 3997 lm/ft
Total Lumens: 8399 lm (for 4ft)
Input Watts: 65.8 W
Efficacy: 32 lm/W

IES FILE: TB3DILED-1100-1000-80-35-SO-0.25G-4.IES

TESTED ACCORDING TO IES LM-79-2008

CANDELA DISTRIBUTION

Vertical Angle	Horizontal Angles				
	0	22.5	45	67.5	90
0	1789	1789	1789	1789	1789
5	1777	1775	1773	1771	1771
15	1681	1673	1655	1637	1629
25	1498	1480	1439	1398	1380
35	1247	1223	1165	1109	1085
45	964	942	882	825	801
55	684	669	623	578	560
65	434	427	402	378	367
75	222	227	225	221	218
85	65	77	92	101	104
90	3	10	18	23	26
95	60	69	81	80	77
105	268	272	273	267	261
115	496	501	506	504	497
125	753	763	769	770	761
135	1024	1033	1043	1044	1038
145	1283	1291	1300	1303	1298
155	1500	1508	1514	1516	1513
165	1655	1658	1661	1661	1659
175	1731	1733	1733	1731	1730
180	1738	1738	1738	1738	1738

ZONAL LUMENS

Zone	Lumens
0	
0-10	168
10-20	465
20-30	661
30-40	729
40-50	682
50-60	559
60-70	400
70-80	238
80-90	96
90	
90-100	78
100-110	273
110-120	482
120-130	667
130-140	785
140-150	798
150-160	689
160-170	465
170-180	164
180	

LUMINANCE DATA (cd/m²)

Vertical Angle	Horizontal Angles		
	0	45	90
45	11999	10972	9972
55	10496	9550	8596
65	9031	8372	7649
75	7556	7654	7414
85	6520	9281	10500

SL SurroundLite - Up
SO Spotless Lens - Down

Uplight
1100 lm/ft
Downlight
1000 lm/ft

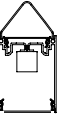

PHOTOMETRIC CURVE

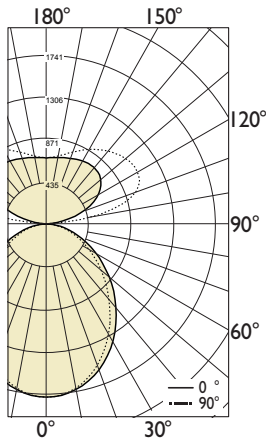

Lumen/ft up: 1100 lm/ft
Lumen/ft down: 1000 lm/ft
Total Lumens: 8403 lm (for 4ft)
Input Watts: 76.4 W
Efficacy: 110 lm/W

IES FILE: TB3DILED-1100-1000-80-35-SL-SO-4.IES

TESTED ACCORDING TO IES LM-79-2008

CANDELA DISTRIBUTION

Vertical Angle	Horizontal Angles				
	0	22.5	45	67.5	90
0	1741	1741	1741	1741	1741
5	1730	1729	1728	1726	1727
15	1636	1631	1620	1610	1605
25	1460	1451	1426	1400	1389
35	1222	1210	1173	1137	1119
45	957	945	905	863	844
55	692	683	647	610	594
65	448	442	416	390	379
75	235	233	220	207	201
85	67	66	62	58	56
90	3	5	6	6	6
95	66	128	138	165	174
105	327	408	565	785	887
115	575	644	788	1010	1131
125	735	794	903	1066	1152
135	804	848	935	1041	1093
145	810	837	903	968	999
155	784	798	836	874	892
165	753	758	771	785	795
175	733	733	733	734	736
180	727	727	727	727	727

ZONAL LUMENS

Zone	Lumens
0	
0-10	163
10-20	456
20-30	655
30-40	733
40-50	697
50-60	579
60-70	413
70-80	234
80-90	72
90	
90-100	175
100-110	613
110-120	811
120-130	827
130-140	728
140-150	567
150-160	388
160-170	220
170-180	70
180	

LUMINANCE DATA (cd/m²)

Vertical Angle	Horizontal Angles		
	0	45	90
45	18489	17479	16308
55	16486	15399	14134
65	14466	13457	12230
75	12386	11631	10617
85	10557	9703	8832

i All IES files are available for download at: www.axislighting.com

● **PHOTOMETRIC DATA**

SL SurroundLite - Up
SO Spotless Lens - Down

Uplight
1000 lm/ft
Downlight
400 lm/ft

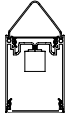

PHOTOMETRIC CURVE

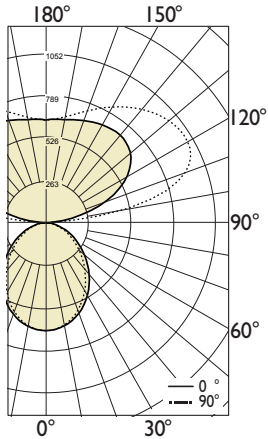

Lumen/ft up: 1000 lm/ft
Lumen/ft down: 400 lm/ft
Total Lumens: 5593 lm (for 4ft)
Input Watts: 50.8 W
Efficacy: 110 lm/W

IES FILE: TB3DILED-1000-400-80-35-SL-SO-4.IES

TESTED ACCORDING TO IES LM-79-2008

CANDELA DISTRIBUTION

Vertical Angle	Horizontal Angles				
	0	22.5	45	67.5	90
0	694	694	694	694	694
5	689	689	688	688	688
15	652	650	645	641	639
25	582	578	568	558	553
35	487	482	467	453	446
45	381	376	361	344	336
55	276	272	258	243	237
65	178	176	166	155	151
75	94	93	88	83	80
85	27	26	25	23	22
90	2	3	4	4	4
95	60	116	126	150	158
105	297	371	513	714	806
115	523	585	716	918	1028
125	668	721	821	969	1047
135	731	771	850	946	993
145	736	760	820	880	908
155	713	725	760	795	810
165	685	689	701	714	722
175	666	666	666	667	669
180	661	661	661	661	661

ZONAL LUMENS

Zone	Lumens
0	
0-10	65
10-20	182
20-30	261
30-40	292
40-50	278
50-60	230
60-70	164
70-80	93
80-90	28
90	
90-100	159
100-110	558
110-120	737
120-130	752
130-140	662
140-150	516
150-160	353
160-170	200
170-180	64
180	

LUMINANCE DATA (cd/m²)

Vertical Angle	Horizontal Angles		
	0	45	90
45	7365	6963	6496
55	6567	6134	5630
65	5763	5361	4872
75	4934	4633	4229
85	4206	3865	3518

i All IES files are available for download at: www.axislighting.com