

Flush Spotless Lens - down  
Glo Lens - up

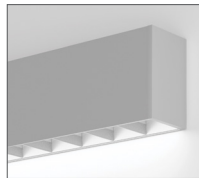

Louver

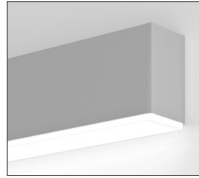

Glo Lens up and down

Project \_\_\_\_\_

Type \_\_\_\_\_

Notes \_\_\_\_\_

**PERFORMANCE PER LINEAR FOOT AT 3500K**

NOMINAL LUMEN OUTPUT		INPUT WATTS*	EFFICACY	SHIELDING I/D
UPLIGHT	DOWNLIGHT			
600 lm/ft	500 lm/ft	9.9 W/ft	112 lm/W	0.25G/SO
600 lm/ft	500 lm/ft	9.9 W/ft	114 lm/ft	LED/SO
1100 lm/ft	-	11.2 W/ft	106 lm/ft	SLA
-	1000 lm/ft	9.9 W/ft	97 lm/W	L

Please consult factory for custom lumen output and wattage.

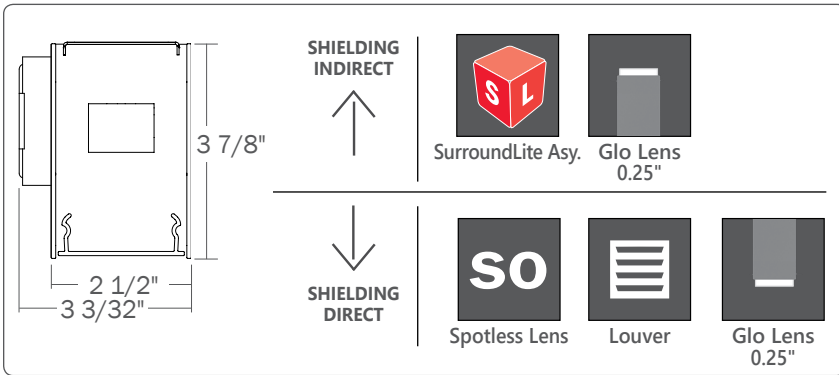

**Ordering Guide**

TB2WDILED		PRODUCT ID		NOM. LUM/FT UP		NOM. LUM/FT DOWN		CRI		COLOR TEMP.		SHIELDING INDIRECT		SHIELDING DIRECT	
TB2WDILED		Twin Beam2 - Wall Direct/Indirect LED		400	400 lm/ft - Min.	400	400 lm/ft - Min.	80	80 CRI	27	2700 K	SO	spotless lens	SO	spotless lens
				1100	1100 lm/ft - Max.	1000	1000 lm/ft - Max.*	90	90 CRI	30	3000 K	SLA	surroundlite asymmetric	L	louver <sup>(1)</sup>
										35	3500 K	0.25G	0.25" Glo lens	0.25G	0.25" Glo lens
										40	4000 K				
				Outputs between listed min and max are available. Consult factory for outputs outside of the listed range.				Outputs between listed min and max are available. Consult factory for outputs outside of the listed range. * 1000 lumens, only for louver.				Choose only one of the options above			
												Choose only one of the options above; SurroundLite not available with direct (1) Available in 3' and 4' combinations; otherwise consult factory.			

LENGTH (FT)	MR (OPTIONAL)	FINISH	VOLTAGE	DRIVER	CIRCUITS
2 2'	DMLED(#) downlight modle LED	AP aluminum paint	120 120 V	DP dimming (0-10V) 1%	1 1 circuit
3 3'		W white	277 277 V	LT Lutron <sup>(2)</sup>	2 2 circuits
4 4'		BLK black	347 347 V	BI bi-level dimming	+E(#) emergency circuit <sup>(4)</sup>
5 5'		C custom	UNV universal	O other <sup>(3)</sup>	+NL(#) night light circuit <sup>(4)</sup>
8 8'					+GTD(#) generator transfer device <sup>(4)</sup>
12 12'					+M MR
S# System Run *					
* SurroundLite available in 1' increments		Add 6" per lamp, Specify quantity		(2) Specify system	
		Separate circuits included.		(3) Please consult factory; see page 2	
				(4) Specify quantity	

BATTERY (OPTIONAL)	OTHER (OPTIONAL)	IC CONTROLS (OPTIONAL)	CUSTOM (OPTIONAL)
B# battery pack (integral)	F fuse <sup>(5)</sup>	DS# daylight sensor OS# occupancy sensor DOS# daylight & occupancy sensor EN# Enlighted integral <sup>(6)</sup> ENR# Enlighted remote <sup>(6)</sup> WC# wireless control dimming	C custom
Minimum 5ft; Not available with 347V Please consult factory	(5) Requires 120V or 277V	(6) Please consult factory Specify quantity. Requires 8" blank. See pages 4-5 for more details. See integrated controls guide for more details.	Please specify

● **SPECIFICATIONS**

**CONSTRUCTION**

<b>Housing</b>	Extruded aluminum (0.075" nominal) Up to 70% recycled content
<b>End Cap</b>	Cast aluminum
<b>Interior Brackets</b>	Die formed sheet steel (20 gauge)
<b>Reflectors</b>	White powder coated sheet steel (22 gauge)
<b>Louvers</b>	Die formed semi-specular aluminum (22 gauge)
<b>Lenses</b>	Extruded acrylic (0.070" nominal)
<b>Hanger</b>	adjustable slide mount
<b>Suspension</b>	Y shape aircraft cable or Ø 1/2" stem

● **ELECTRICAL**

<b>Lutron driver*</b>	LDE1 - EcoSystem H-Series (1%) LDE5 - EcoSystem 5-Series (5%) LTE - Hi-Lume® A-series 2Wires Forward Phase (1%) *Consult factory
<b>Other drivers</b>	DALI - Digital Addressable Lighting Interface DMX - Digital Multiplex LV - line voltage - Advance Mark 10 Xitanium SR - For wireless sensor POE (Power over Ethernet) - Low Voltage Lighting System.
<b>Emergency</b>	Integral emergency battery pack or emergency circuit optional.
<b>Input Voltage</b>	120V, 277V, 347V, UNV.

**i** Incorporating these components may have limitations or affect the length of the luminaire. Please contact factory for more details.

● **LED SYSTEM**

<b>CRI</b>	Minimum 80 or 90 color rendering index.
<b>CCT</b>	Choice of 2700K, 3000K, 3500K and 4000K color temperature with a great color consistency (within 3-step MacAdam ellipse). Both within fixture and fixture to fixture.
<b>LED life</b>	Minimum 50,000h with 85% of lumen maintenance in 25°C ambient temperature, in compliance with IES LM-80 testing measurements.
<b>Thermal Management</b>	Aluminum housing acting as the heat sink to maximize life.
<b>Environment</b>	Dry and damp rated in operating ambient temperatures of 0-40°C (32-104F).
<b>Louver LED</b>	Individual LED cluster in each louver cell.

● **OPTICS**

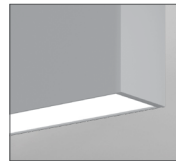

SO Spotless lens



L Louver

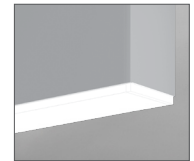

0.25G Glo lens

**SPOTLESS LENS**

Frosted acrylic snap-in micro lens

**PARABOLIC LOUVERS**

Die formed semi-specular aluminum (22 gauge)

**GLO LENS**

0.25" frosted acrylic drop lens. Patented design.

● **SYSTEM (S#)**

TWIN BEAM2 SurroundLite linear systems, with the use of a strong profile, allow for a nearly hair thin connection system of continuous runs. Lengths of 4', 8', 12' as well as custom lengths are available. Runs of TWIN BEAM2 SurroundLite that are greater than 12' in length are designated as systems (S#). This means that the run is comprised of a combination of 4', 8' and/or 12' sections to be assembled on site using our joining system. System runs with SurroundLite available in 1' increments only. For more information on systems and joining, please refer to the BEAM installation sheets available for download at [www.axislighting.com](http://www.axislighting.com).

● **WARRANTY**

Axis Lighting will warrant defective LEDs, boards, and drivers for 5 years from date of purchase. Warranty is valid if luminaire is installed and used according to specifications. If defective, Axis will send replacement boards or drivers at no cost along with detailed replacement instructions and instructions on how to return defective components to Axis.

● **WEIGHT**

<b>Direct/Indirect 4 ft</b>	13.2 lbs / 6.0 kg
<b>Direct/Indirect 8 ft</b>	26.4 lbs / 12.0 kg
<b>Direct/Indirect 12 ft</b>	39.6 lbs / 18.0 kg

● **InstaJoiner**

TWIN BEAM2 SurroundLite luminaires feature InstaJoiner, a unique, patent-pending, joining system developed by Axis offering fast, single-screw tightening.

**NOTE:** Mount each system segment individually.  
Do not assemble system prior to mounting.

**i** Allow a minimum of 6" between end of long runs and wall.

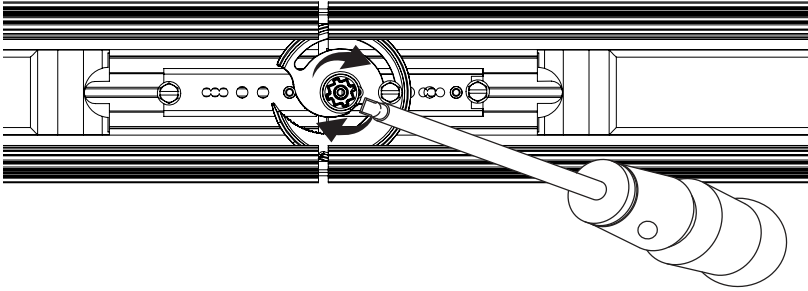

**i** Patent - Pending

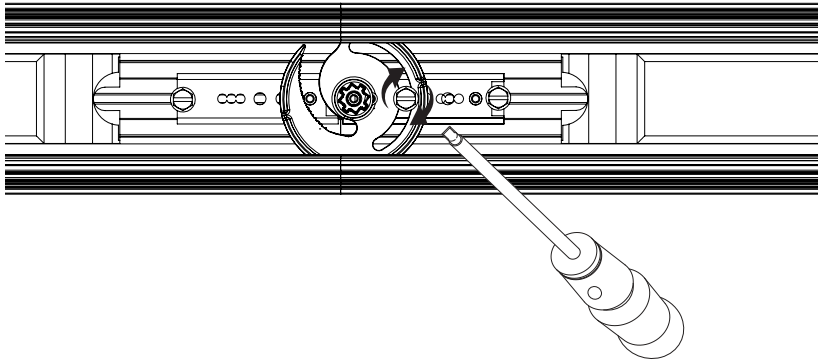

● **SECTION VIEWS**

**0.25G 0.25" Glo lens - Indirect**

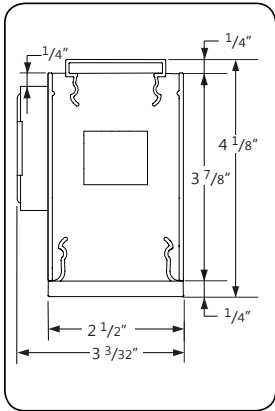

**0.25G 0.25" Glo lens - Direct**

**SO Spotless lens - Indirect**

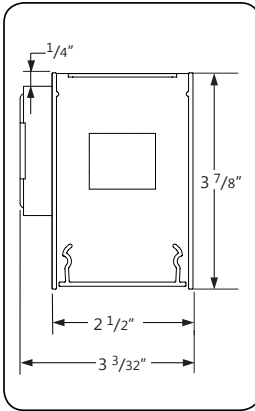

**SO Spotless lens - Direct**

**SO Spotless lens - Indirect**

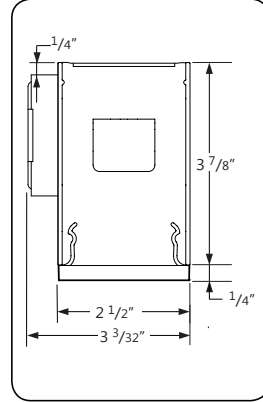

**0.25G 0.25" Glo lens - Direct**

**SO Spotless lens - Indirect**

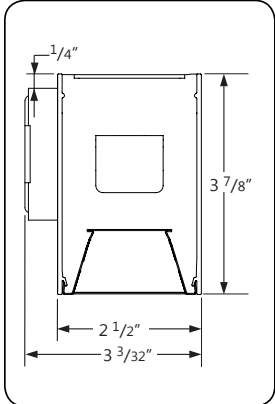

**L Louver - Direct**

**0.25G 0.25" Glo lens - Indirect**

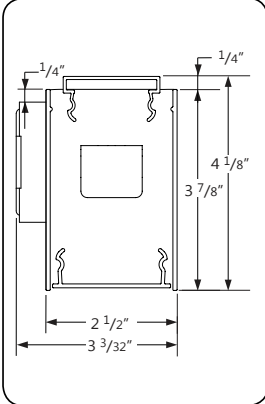

**SO Spotless lens - Direct**

**0.25G 0.25" Glo lens - Indirect**

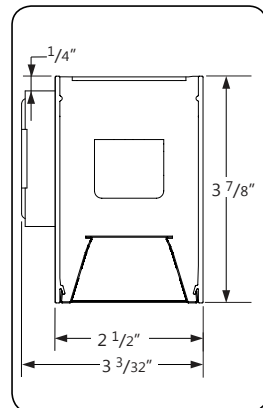

**L Louver - Direct**

**SLA SurroundLite Asymmetric - Indirect**

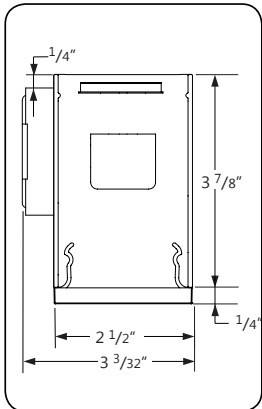

**0.25G 0.25" Glo lens - Direct**

**SLA SurroundLite Asymmetric - Indirect**

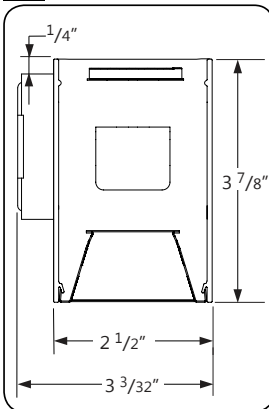

**L Louver - Direct**

**SLA SurroundLite Asymmetric - Indirect**

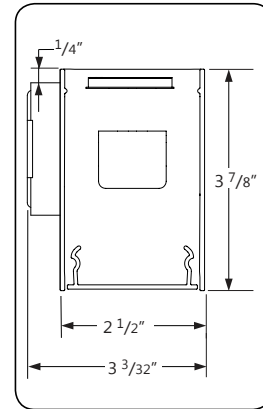

**SO Spotless lens - Direct**

● **MOUNTING OPTIONS**

**HORIZONTAL MOUNTING DETAILS**

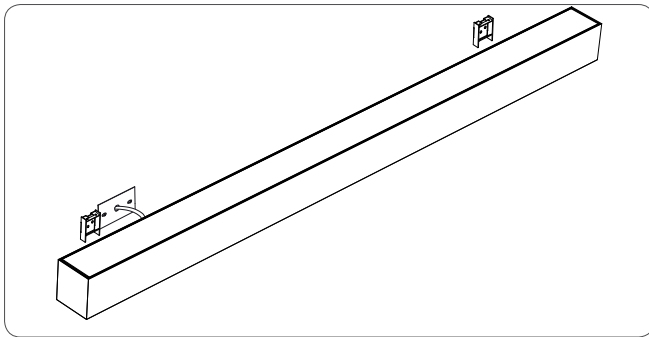

**MOUNTING BRACKETS**

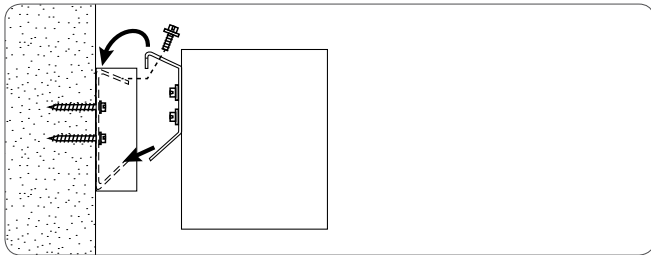

**SIDE VIEW**

**VERTICAL MOUNTING DETAILS**

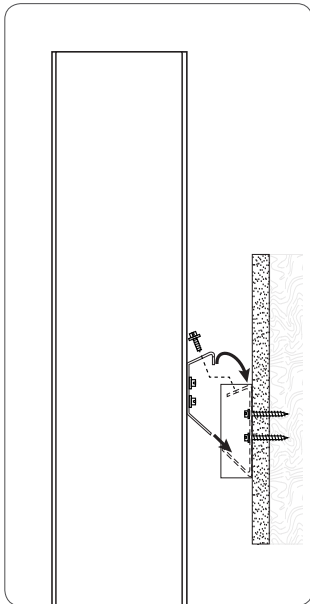

**MOUNTING BRACKETS**

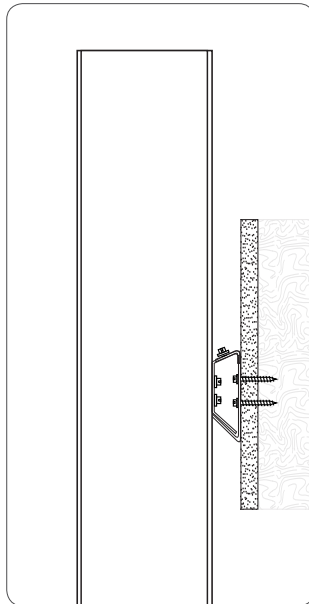

**SIDE VIEW**

● **OTHER MOUNTING OPTIONS**

TWIN BEAM2 SurroundLite is also available with wall and horizontal wall mounted options.

**i** Specification sheets and installation sheets for all mountings for TWIN BEAM2 SurroundLite luminaires are available for download at [www.axislighting.com](http://www.axislighting.com)

● **FINISH**

Aluminium paint, powder coated and custom finishes are also available.

● **DMLED MODULE**

**Blank LED Module Quantity** Extruded aluminum (0.075" nominal) 2" diameter  
For every 4' section, there may be up to a maximum of 4 x DMLED module.

**Spacing** Each DMLED module is placed centered on a blank section 6" in length.

For a series of modules within a given section length, they will be spaced evenly on a longer blank section.  
Custom spacing may be available on special request.

**Tilt** 15° each side.

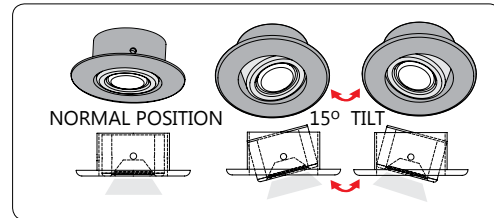

**Between sections**

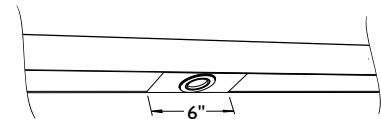

**At luminaire ends**

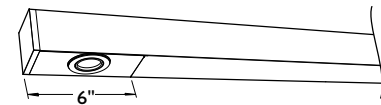

**Several in a long blank section**

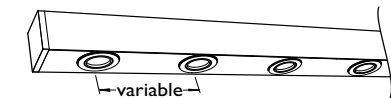

**Beam Angle** 30 nominal degrees  
**Input Watts** 3W  
**Nominal Lumens** 126 lumens  
**Efficacy** 42 lumens per watt  
**Color Rendering Index (CRI)** 80  
**Life** 25,000 hours at L<sub>70</sub>  
**Correlated color temperature (CCT)** 3000K

**i** More options are available upon request. Please consult factory.

\* See photometric report.

● **APPROVALS**

Certified to UL and CUL standards  
Meets NYC requirements  
Meets ADA requirements.  
Suitable for damp locations.



● **PHOTOMETRIC DATA**

**0.25G 0.25" Glo lens - Up**  
**SO spotless lens - Down**

**Uplight**  
**600 lm/ft**  
**Downlight**  
**500 lm/ft**

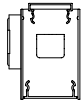

**PHOTOMETRIC CURVE**

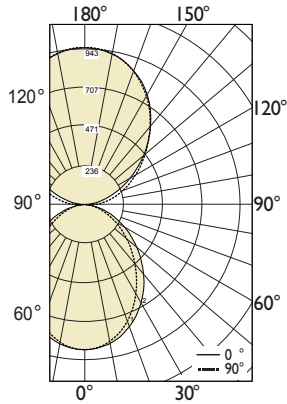

**Lumen/ft up: 600 lm/ft**  
**Lumen/ft down: 500 lm/ft**  
**Total Lumens: 4418 lm (for 4ft)**  
**Input Watts: 39.6 W**  
**Efficacy: 112 lm/W**  
IES FILE: TB2DILED-600-500-80-35-0.25G-SO-4.IES

TESTED ACCORDING TO IES LM-79-2008

**CANDELA DISTRIBUTION**

Vertical Angle	Horizontal Angles				
	0	22.5	45	67.5	90
0	871	871	871	871	871
5	863	863	864	865	865
15	799	802	809	818	820
25	686	693	710	728	736
35	546	556	583	609	619
45	406	417	445	474	485
55	280	290	314	340	349
65	173	181	198	217	223
75	88	91	101	111	115
85	21	22	25	29	31
90	1	1	1	1	2
95	103	98	80	55	32
105	195	189	170	145	124
115	297	292	280	262	247
125	414	412	408	401	392
135	545	545	550	548	543
145	682	684	691	692	690
155	805	806	812	812	813
165	895	894	897	894	895
175	938	938	940	936	936
180	942	942	942	942	942

**ZONAL LUMENS**

Zone	Lumens
0	
0-10	82
10-20	228
20-30	327
30-40	364
40-50	344
50-60	282
60-70	198
70-80	108
80-90	31
90	
90-100	73
100-110	176
110-120	275
120-130	364
130-140	422
140-150	430
150-160	373
160-170	252
170-180	89
180	

**LUMINANCE DATA (cd/m²)**

Vertical Angle	Horizontal Angles		
	0	45	90
45	9554	10484	11427
55	8130	9123	10148
65	6835	7817	8802
75	5645	6495	7389
85	4014	4817	5964

**SO spotless lens - Up**  
**SO spotless lens - Down**

**Uplight**  
**600 lm/ft**  
**Downlight**  
**500 lm/ft**

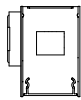

**PHOTOMETRIC CURVE**

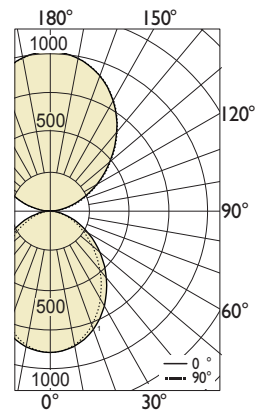

**Lumen/ft up: 600 lm/ft**  
**Lumen/ft down: 500 lm/ft**  
**Total Lumens: 492 lm (for 4ft)**  
**Input Watts: 39.5 W**  
**Efficacy: 114 lm/W**  
IES FILE: TB2DILED-600-500-80-35-SO-SO-4.IES

TESTED ACCORDING TO IES LM-79-2008

**CANDELA DISTRIBUTION**

Vertical Angle	Horizontal Angles				
	0	22.5	45	67.5	90
0	883	883	883	883	883
5	875	875	876	877	877
15	810	813	820	827	829
25	696	703	718	734	740
35	554	564	588	610	619
45	412	423	448	474	483
55	284	294	316	340	348
65	176	183	200	217	222
75	89	93	102	112	114
85	21	23	26	29	31
90	1	1	1	1	1
95	48	47	46	43	38
105	154	154	151	145	142
115	277	276	278	276	273
125	420	421	421	423	421
135	574	575	576	577	575
145	724	725	727	727	727
155	853	853	854	854	854
165	944	944	944	945	944
175	990	989	989	989	990
180	994	994	994	994	994

**ZONAL LUMENS**

Zone	Lumens
0	
0-10	83
10-20	231
20-30	330
30-40	367
40-50	346
50-60	284
60-70	199
70-80	109
80-90	31
90	
90-100	50
100-110	159
110-120	274
120-130	377
130-140	444
140-150	454
150-160	393
160-170	266
170-180	94
180	

**LUMINANCE DATA (cd/m²)**

Vertical Angle	Horizontal Angles		
	0	45	90
45	7949	8655	9324
55	6771	7533	8275
65	5700	6459	7186
75	4701	5387	6025
85	3353	4011	4888

**i** All IES files for other lamping are available for download at: [www.axislighting.com](http://www.axislighting.com)

● **PHOTOMETRIC DATA**

**L louver - Down**

Uplight  
**0 lm/ft**  
Downlight  
**1000 lm/ft**

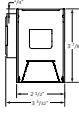

**PHOTOMETRIC CURVE**

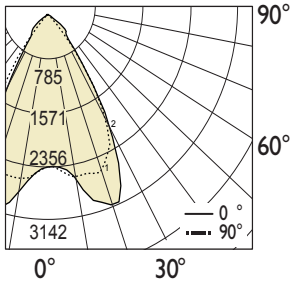

Lumen/ft up: **0 lm/ft**  
Lumen/ft down: **1000 lm/ft**  
Total Lumens: **3854 lm (for 4ft)**  
Input Watts: **39.6 W**  
Efficacy: **97 lm/W**

IES FILE: TB2DILED-0-1000-80-35-L-4.IES

TESTED ACCORDING TO IES LM-79-2008

**CANDELA DISTRIBUTION**

Vertical Angle	Horizontal Angles				
	0	22.5	45	67.5	90
0	2297	2297	2297	2297	2297
5	2356	2348	2337	2321	2312
15	2483	2504	2693	2915	2904
25	2322	2513	3107	3055	2851
35	1290	1752	2342	1633	1320
45	194	307	658	478	428
55	32	48	76	175	250
65	6	8	13	17	20
75	2	2	3	5	5
85	0	1	1	1	1
90	0	0	0	0	0

**ZONAL LUMENS**

Zone	Lumens
0	
0-10	228
10-20	768
20-30	1260
30-40	1073
40-50	397
50-60	106
60-70	19
70-80	4
80-90	1
90	

**LUMINANCE DATA (cd/m²)**

Vertical Angle	Horizontal Angles		
	0	45	90
45	4597	15642	10171
55	949	2223	7334
65	219	521	807
75	110	208	312
85	77	154	212

**i** All IES files for other lamping are available for download at: [www.axislighting.com](http://www.axislighting.com)