

Flush Spotless Lens - down
Glo Lens - up

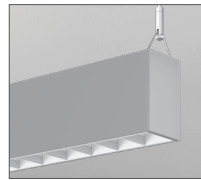

Louver



Glo Lens up and down

Project _____

Type _____

Notes _____

PERFORMANCE PER LINEAR FOOT AT 3500K

NOMINAL LUMEN OUTPUT		INPUT WATTS*	EFFICACY	SHIELDING I/D
UPLIGHT	DOWNLIGHT			
1100 lm/ft	1000 lm/ft	20.6 W/ft	100 lm/W	SL/L
600 lm/ft	500 lm/ft	9.9 W/ft	112 lm/W	0.25G/SO
600 lm/ft	500 lm/ft	9.9 W/ft	114 lm/W	LED/SO
1100 lm/ft	-	11.2 W/ft	106 lm/W	SLA
1100 lm/ft	-	10.7 W/ft	103 lm/W	SL
-	1000 lm/ft	9.9 W/ft	97 lm/W	L

Please consult factory for custom lumen output and wattage.



*Check the latest update on the DLC website for complete information. Not all versions may be DLC qualified. See page 2 for DLC Approved Options

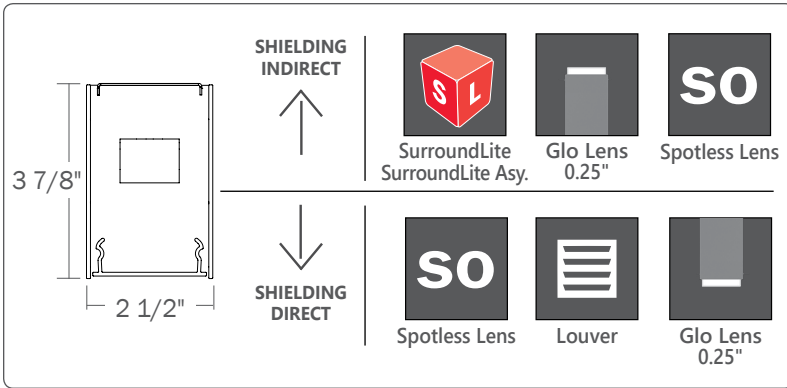

Ordering Guide

TB2DILED		PRODUCT ID		NOM. LUM/FT UP		NOM. LUM/FT DOWN		CRI		COLOR TEMP.		SHIELDING INDIRECT		SHIELDING DIRECT			
		Twin Beam 2 - Pendant Direct/Indirect LED		400 400 lm/ft - Min. 1100 1100 lm/ft - Max.		400 400 lm/ft - Min. 1000 1000 lm/ft - Max. *		80 80 CRI 90 90 CRI		27 2700 K 30 3000 K 35 3500 K 40 4000 K		SO spotless lens SL surroundlite SLA surroundlite asymmetric 0.25G 0.25" Glo lens		SO spotless lens L louver (1) 0.25G 0.25" Glo lens			
				Outputs between listed min and max are available. Consult factory for outputs outside of the listed range.				Outputs between listed min and max are available. Consult factory for outputs outside of the listed range. * 1000 lumens, only for louver.				Consult Axitune spec sheet for Axis color technology options		Choose only one of the options above		Choose only one of the options above; SurroundLite not available with direct (1) Available in 3' and 4' combinations; otherwise consult factory.	

LENGTH (FT)	MR (OPTIONAL)	FINISH	VOLTAGE	DRIVER	CIRCUITS
2 2' 3 3' 4 4' 5 5' 8 8' 12 12' S# System Run *	DMLED(#) downlight modle LED	AP aluminum paint W white BLK black C custom	120 120 V 277 277 V 347 347 V UNV universal	DP dimming (0-10V) 1% LT Lutron (2) BI bi-level dimming O other (3)	1 1 circuit 2 2 circuits +E(#) emergency circuit (4) +NL(#) night light circuit (4) +GTD(#) generator transfer device (4) +M MR
* SurroundLite available in 1 increments		Add 6" per lamp. Specify quantity. Separate circuits included.		(2) Specify system (3) Please consult factory; see page 2 Consult Axitune spec sheet for Axis color driver options	

MOUNTING/SUSPENSION	BATTERY (OPTIONAL)	OTHER (OPTIONAL)	IC CONTROLS (OPTIONAL)	CUSTOM (OPTIONAL)
CA(#) drywall+cable length (36" std.) CT9(#) TB/TG 9/16+cable length (36" std.) CT15(#) TB/TG15/16+cable length (36" std.) CTS(#) ST+cable length (36" std.) SA(#) drywall+stem length >48" (18" std.)	B# battery pack (integral)	F fuse (5)	DS# daylight sensor OS# occupancy sensor DOS# daylight & occupancy sensor EN# Enlighted integral (6) ENR# Enlighted remote (6) WC# wireless control dimming	C custom
White canopy standard	Minimum 5ft; Not available with 347V. Please consult factory.	(5) Requires 120V or 277V	(6) Please consult factory. Specify quantity. Requires 8" blank. See integrated controls guide for more details.	Please specify

● **SPECIFICATIONS**

CONSTRUCTION

Housing	Extruded aluminum (0.075" nominal) Up to 70% recycled content
End Cap	Cast aluminum
Interior Brackets	Die formed sheet steel (20 gauge)
Reflectors	White powder coated sheet steel (22 gauge)
Louvers	Die formed semi-specular aluminum (22 gauge)
Lenses	Extruded acrylic (0.070" nominal)
Hanger	adjustable slide mount
Suspension	Y shape aircraft cable or Ø 1/2" stem

● **ELECTRICAL**

Lutron driver*	LDE1 - EcoSystem H-Series (1%) LDE5 - EcoSystem 5-Series (5%) LTE - Hi-Lume® A-series 2Wires Forward Phase (1%) *Consult factory
Other drivers	DALI - Digital Addressable Lighting Interface DMX - Digital Multiplex LV - line voltage - Advance Mark 10 Xitanium SR - For wireless sensor POE (Power over Ethernet) - Low Voltage Lighting System.
Emergency	Integral emergency battery pack or emergency circuit optional.
Input Voltage	120V, 277V, 347V, UNV.

i Incorporating these components may have limitations or affect the length of the luminaire. Please contact factory for more details.

● **LED SYSTEM**

CRI	Minimum 80 or 90 color rendering index.
CCT	Choice of 2700K, 3000K, 3500K and 4000K color temperature with a great color consistency (within 3-step MacAdam ellipse). Both within fixture and fixture to fixture.
LED life	Minimum 50,000h with 85% of lumen maintenance in 25°C ambient temperature, in compliance with IES LM-80 testing measurements.
Thermal Management	Aluminum housing acting as the heat sink to maximize life.
Environment	Dry and damp rated in operating ambient temperatures of 0-40°C (32-104F).
Louver LED	Individual LED cluster in each louver cell.

● **OPTICS**

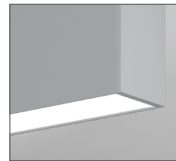

SO Spotless lens



L Louver

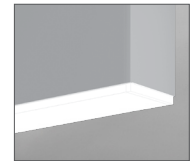

0.25G Glo lens

SPOTLESS LENS

Frosted acrylic snap-in micro lens

PARABOLIC LOUVERS

Die formed semi-specular aluminum (22 gauge)

GLO LENS

0.25" frosted acrylic drop lens. Patented design.

● **SYSTEM (S#)**

TWIN BEAM2 SurroundLite linear systems, with the use of a strong profile, allow for a nearly hair thin connection system of continuous runs. Lengths of 4', 8', 12' as well as custom lengths are available. Runs of TWIN BEAM2 SurroundLite that are greater than 12' in length are designated as systems (S#). This means that the run is comprised of a combination of 4', 8' and/or 12' sections to be assembled on site using our joining system. System runs with SurroundLite available in 1' increments only. For more information on systems and joining, please refer to the BEAM installation sheets available for download at www.axislighting.com.

● **WARRANTY**

Axis Lighting will warrant defective LEDs, boards, and drivers for 5 years from date of purchase. Warranty is valid if luminaire is installed and used according to specifications. If defective, Axis will send replacement boards or drivers at no cost along with detailed replacement instructions and instructions on how to return defective components to Axis.

● **WEIGHT**

Direct/Indirect 4 ft	13.2 lbs / 6.0 kg
Direct/Indirect 8 ft	26.4 lbs / 12.0 kg
Direct/Indirect 12 ft	39.6 lbs / 18.0 kg



*Check the latest update on the DLC website for complete information. Not all versions may be DLC qualified.

● **DLC Approved Options**

OUTPUT UP	OUTPUT DOWN	CRI	COLOR TEMP.	SHIELDING INDIRECT	SHIELDING DIRECT	LENGTH	FINISH	VOLTAGE	DRIVER	CIRCUITS
400 lm/ft	600 lm/ft	80	3500 K	SL	SO	4' 6' 7' 8' 10'	white	universal	DP	1

● **InstaJoiner**

TWIN BEAM2 SurroundLite luminaires feature InstaJoiner, a unique, patent-pending joining system developed by Axis offering fast, single-screw tightening.

NOTE: Mount each system segment individually.

Do not assemble system prior to mounting

i Allow a minimum of 6" between end of long runs and wall.

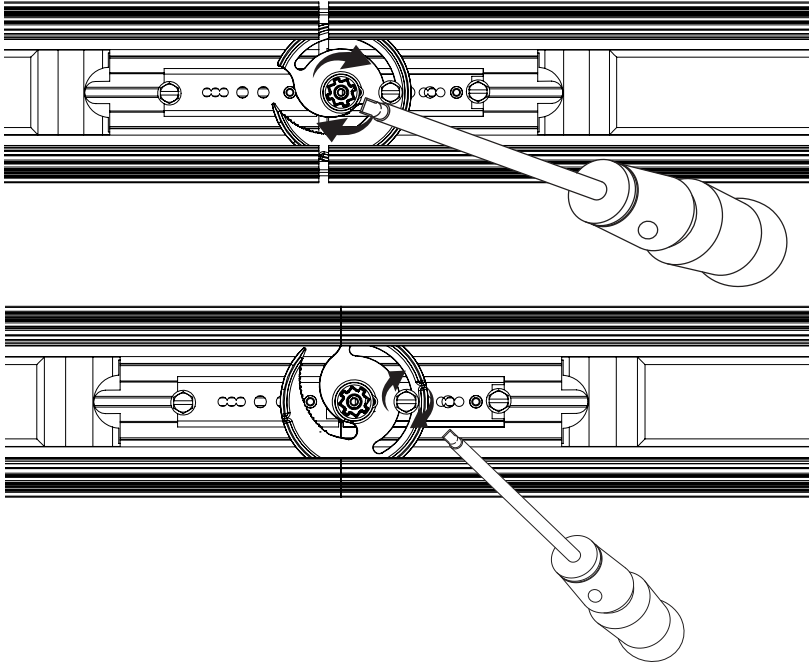

i Patent - Pending

SECTION VIEWS

0.25G 0.25" Glo lens - Indirect

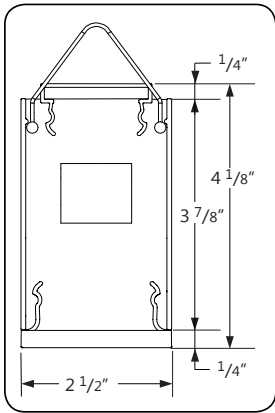

0.25G 0.25" Glo lens - Direct

SL SurroundLite - Indirect

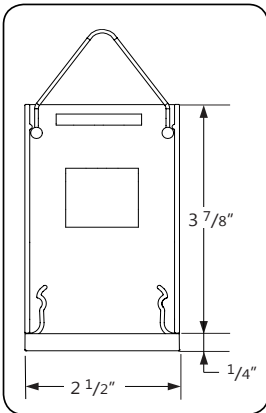

0.25G 0.25" Glo lens - Direct

SO Spotless lens - Indirect

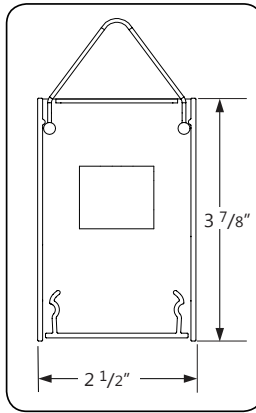

SO Spotless lens - Direct

SL SurroundLite - Indirect

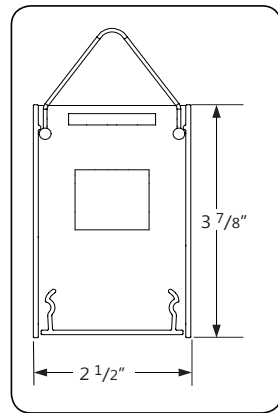

SO Spotless lens - Direct

SO Spotless lens - Indirect

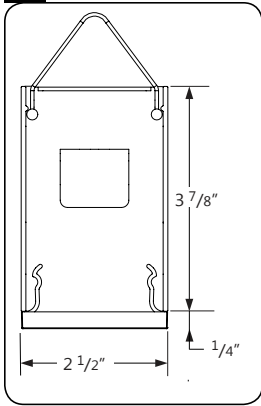

0.25G 0.25" Glo lens - Direct

SL SurroundLite - Indirect

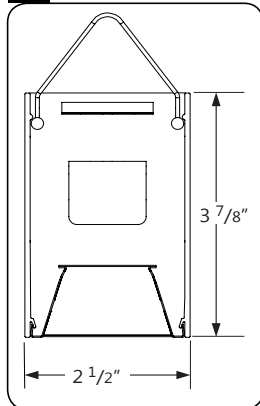

L Louver - Direct

SO Spotless lens - Indirect

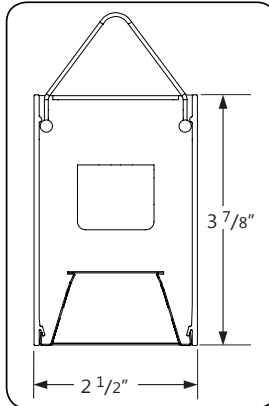

L Louver - Direct

0.25G 0.25" Glo lens - Indirect

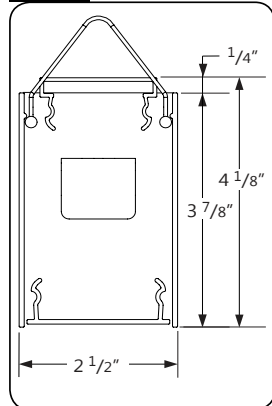

SO Spotless lens - Direct

SLA SurroundLite Asymmetric - Indirect

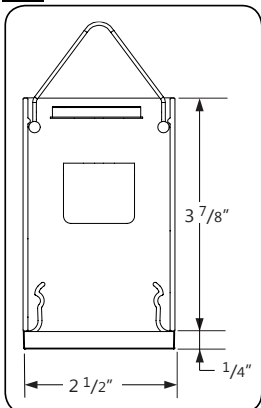

0.25G 0.25" Glo lens - Direct

SLA SurroundLite Asymmetric - Indirect

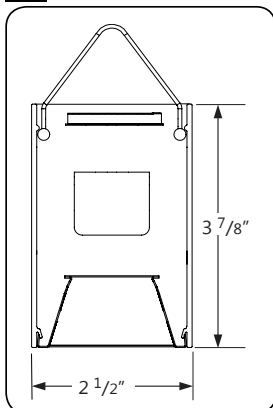

L Louver - Direct

SLA SurroundLite Asymmetric - Indirect

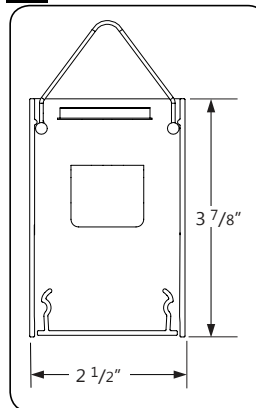

SO Spotless lens - Direct

0.25G 0.25" Glo lens - Indirect

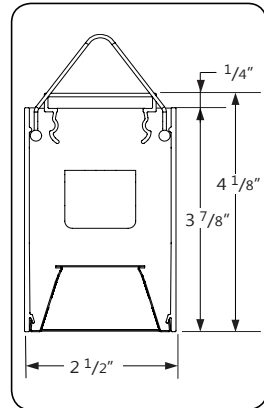

L Louver - Direct

● **MOUNTING OPTIONS**

CT TILE CEILING - ON GRID

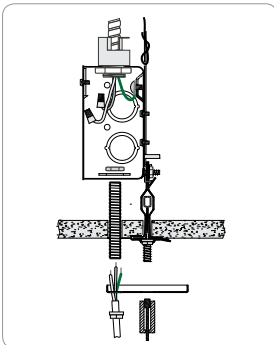

Power feed

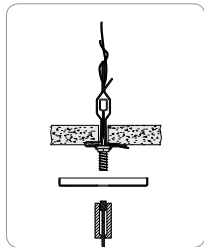

Non power feed

CA DRYWALL CEILING

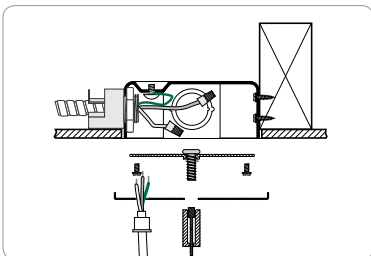

Power feed

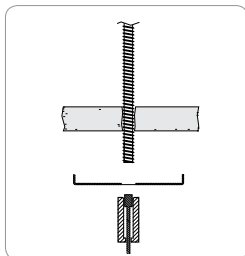

Non power feed

SA STEM MOUNT IN DRYWALL CEILING

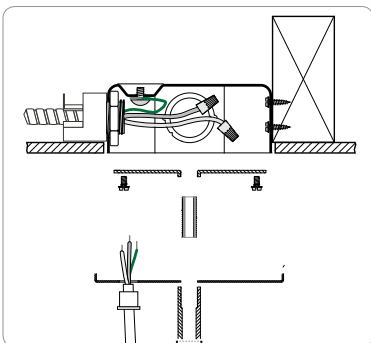

Power feed

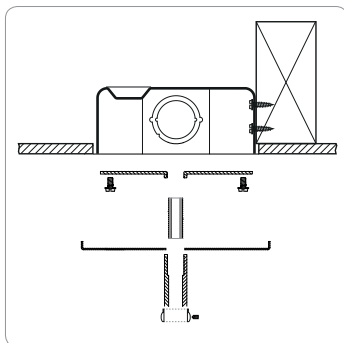

Non power feed

● **OTHER MOUNTING OPTIONS**

TWIN BEAM2 SurroundLite is also available with wall and horizontal wall mounted options.

i Specification sheets and installation sheets for all mountings for TWIN BEAM2 SurroundLite luminaires are available for download at www.axislighting.com

● **FINISH**

Aluminium paint, powder coated and custom finishes are also available.

● **DMLED MODULE**

Blank LED Module Quantity Spacing
 Extruded aluminum (0.075" nominal) 2" diameter
 For every 4' section, there may be up to a maximum of 4 x DMLED module. Each DMLED module is placed centered on a blank section 6" in length.

For a series of modules within a given section length, they will be spaced evenly on a longer blank section. Custom spacing may be available on special request.

Tilt 15° each side.

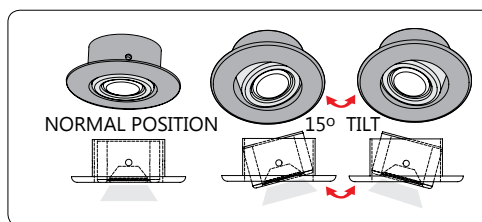

Between sections

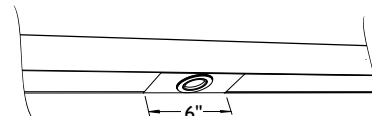

At luminaire ends

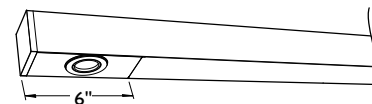

Several in a long blank section

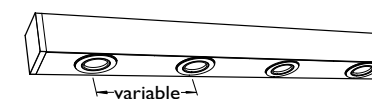

Beam Angle 30 nominal degrees
Input Watts 3W
Nominal Lumens 126 lumens
Efficacy 42 lumens per watt
Color Rendering Index (CRI) 80
Life 25,000 hours at L₇₀
Correlated color temperature (CCT) 3000K

i More options are available upon request. Please consult factory.

* See photometric report.

● **APPROVALS**

Certified to UL and CUL standards 
 Meets NYC requirements
 Meets ADA requirements.
 Suitable for damp locations.

● **PHOTOMETRIC DATA**

SL SurroundLite - Up
L louver - Down

Uplight
1100 lm/ft
Downlight
1000 lm/ft

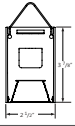

PHOTOMETRIC CURVE

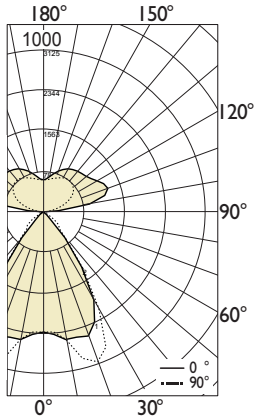

Lumen/ft up: 1100 lm/ft
Lumen/ft down: 1000 lm/ft
Total Lumens: 8257 lm (for 4ft)
Input Watts: 82.3 W
Efficacy: 100 lm/W

IES FILE: TB2DILED-1100-1000-80-35-SL-L-4.IES

TESTED ACCORDING TO IES LM-79-2008

CANDELA DISTRIBUTION

Vertical Angle	Horizontal Angles				
	0	22.5	45	67.5	90
0	2297	2297	2297	2297	2297
5	2356	2348	2337	2321	2312
15	2483	2504	2693	2915	2904
25	2322	2513	3107	3055	2851
35	1290	1752	2342	1633	1320
45	194	307	658	478	428
55	32	48	76	175	250
65	6	8	13	17	20
75	2	2	3	5	5
85	0	1	1	1	1
90	3	3	2	2	2
95	293	308	219	124	66
105	1221	1009	538	368	315
115	1276	1039	697	585	553
125	1119	997	815	737	706
135	1040	986	885	811	779
145	991	960	889	816	779
155	900	879	823	756	725
165	758	745	711	675	660
175	633	631	627	622	620
180	614	614	614	614	614

ZONAL LUMENS

Zone	Lumens
0	
0-10	228
10-20	768
20-30	1260
30-40	1073
40-50	397
50-60	106
60-70	19
70-80	4
80-90	1
90	
90-100	250
100-110	688
110-120	799
120-130	775
130-140	693
140-150	555
150-160	378
160-170	203
170-180	61
180	

LUMINANCE DATA (cd/m²)

Vertical Angle	Horizontal Angles		
	0	45	90
45	4597	15642	10171
55	949	2223	7334
65	219	521	807
75	110	208	312
85	77	154	212

i All IES files are available for download at: www.axislighting.com

● **PHOTOMETRIC DATA**

0.25G 0.25" Glo lens - Up
SO spotless lens - Down

Uplight
600 lm/ft
Downlight
500 lm/ft

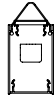

PHOTOMETRIC CURVE

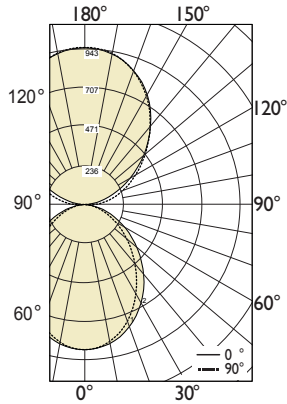

Lumen/ft up: 600 lm/ft
Lumen/ft down: 500 lm/ft
Total Lumens: 4418 lm (for 4ft)
Input Watts: 39.6 W
Efficacy: 112 lm/W
IES FILE: TB2DILED-600-500-80-35-0.25G-SO-4.IES

TESTED ACCORDING TO IES LM-79-2008

CANDELA DISTRIBUTION

Vertical Angle	Horizontal Angles				
	0	22.5	45	67.5	90
0	871	871	871	871	871
5	863	863	864	865	865
15	799	802	809	818	820
25	686	693	710	728	736
35	546	556	583	609	619
45	406	417	445	474	485
55	280	290	314	340	349
65	173	181	198	217	223
75	88	91	101	111	115
85	21	22	25	29	31
90	1	1	1	1	2
95	103	98	80	55	32
105	195	189	170	145	124
115	297	292	280	262	247
125	414	412	408	401	392
135	545	545	550	548	543
145	682	684	691	692	690
155	805	806	812	812	813
165	895	894	897	894	895
175	938	938	940	936	936
180	942	942	942	942	942

ZONAL LUMENS

Zone	Lumens
0	
0-10	82
10-20	228
20-30	327
30-40	364
40-50	344
50-60	282
60-70	198
70-80	108
80-90	31
90	
90-100	73
100-110	176
110-120	275
120-130	364
130-140	422
140-150	430
150-160	373
160-170	252
170-180	89
180	

LUMINANCE DATA (cd/m²)

Vertical Angle	Horizontal Angles		
	0	45	90
45	9554	10484	11427
55	8130	9123	10148
65	6835	7817	8802
75	5645	6495	7389
85	4014	4817	5964

SO spotless lens - Up
SO spotless lens - Down

Uplight
600 lm/ft
Downlight
500 lm/ft

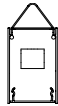

PHOTOMETRIC CURVE

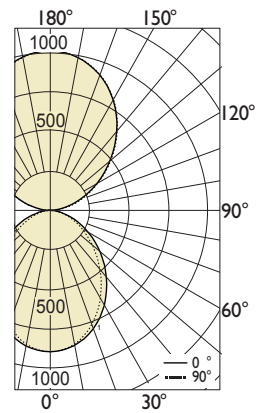

Lumen/ft up: 600 lm/ft
Lumen/ft down: 500 lm/ft
Total Lumens: 492 lm (for 4ft)
Input Watts: 39.5 W
Efficacy: 114 lm/W
IES FILE: TB2DILED-600-500-80-35-SO-SO-4.IES

TESTED ACCORDING TO IES LM-79-2008

CANDELA DISTRIBUTION

Vertical Angle	Horizontal Angles				
	0	22.5	45	67.5	90
0	883	883	883	883	883
5	875	875	876	877	877
15	810	813	820	827	829
25	696	703	718	734	740
35	554	564	588	610	619
45	412	423	448	474	483
55	284	294	316	340	348
65	176	183	200	217	222
75	89	93	102	112	114
85	21	23	26	29	31
90	1	1	1	1	1
95	48	47	46	43	38
105	154	154	151	145	142
115	277	276	278	276	273
125	420	421	421	423	421
135	574	575	576	577	575
145	724	725	727	727	727
155	853	853	854	854	854
165	944	944	944	945	944
175	990	989	989	989	990
180	994	994	994	994	994

ZONAL LUMENS

Zone	Lumens
0	
0-10	83
10-20	231
20-30	330
30-40	367
40-50	346
50-60	284
60-70	199
70-80	109
80-90	31
90	
90-100	50
100-110	159
110-120	274
120-130	377
130-140	444
140-150	454
150-160	393
160-170	266
170-180	94
180	

LUMINANCE DATA (cd/m²)

Vertical Angle	Horizontal Angles		
	0	45	90
45	7949	8655	9324
55	6771	7533	8275
65	5700	6459	7186
75	4701	5387	6025
85	3353	4011	4888

ⓘ All IES files for other lamping are available for download at: www.axislighting.com

● **PHOTOMETRIC DATA**

SLA SurroundLite asymmetric - Up

Uplight
1100 lm/ft
Downlight
0 lm/ft

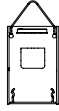

PHOTOMETRIC CURVE

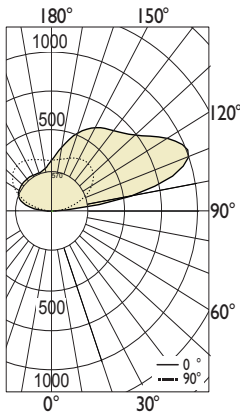

Lumen/ft up: 1100 lm/ft
Lumen/ft down: 0 lm/ft
Total Lumens: 4731 lm (for 4ft)
Input Watts: 44.7 W
Efficacy: 106 lm/W
IES FILE: TB2DILED-1100-0-80-35-SLA-4.IES

TESTED ACCORDING TO IES LM-79-2008

CANDELA DISTRIBUTION

Vertical Angle	Horizontal Angles								
	0	22.5	45	67.5	90	112.5	135	157.5	180
90	0	0	0	0	0	0	0	0	0
95	228	325	263	142	83	132	163	188	186
105	1938	1724	828	456	357	353	368	432	463
115	2239	1803	1021	729	615	544	490	531	569
125	1860	1589	1165	942	784	660	569	574	595
135	1572	1477	1258	1054	870	709	608	594	600
145	1440	1403	1258	1073	879	715	619	595	594
155	1289	1259	1156	993	833	699	619	589	582
165	1060	1036	970	873	774	688	630	600	590
175	818	811	793	766	735	705	681	664	659
180	727	727	727	727	727	727	727	727	727

ZONAL LUMENS

Zone	Lumens
90	
90-100	240
100-110	732
110-120	878
120-130	841
130-140	740
140-150	592
150-160	410
160-170	228
170-180	71
180	

SL SurroundLite - Up

Uplight
1100 lm/ft
Downlight
0 lm/ft

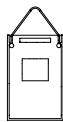

PHOTOMETRIC CURVE

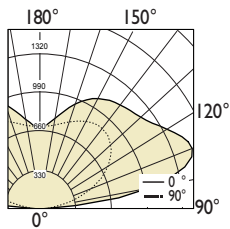

Lumen/ft up: 1100 lm/ft
Lumen/ft down: 0 lm/ft
Total Lumens: 4402 lm (for 4ft)
Input Watts: 42.7 W
Efficacy: 103 lm/W
IES FILE: TB2DILED-1100-0-80-35-SL-4.IES

TESTED ACCORDING TO IES LM-79-2008

CANDELA DISTRIBUTION

Vertical Angle	Horizontal Angles				
	0	22.5	45	67.5	90
90	3	3	2	2	2
95	293	308	219	124	66
105	1221	1009	538	368	315
115	1276	1039	697	585	553
125	1119	997	815	737	706
135	1040	986	885	811	779
145	991	960	889	816	779
155	900	879	823	756	725
165	758	745	711	675	660
175	633	631	627	622	620
180	614	614	614	614	614

ZONAL LUMENS

Zone	Lumens
90	
90-100	250
100-110	688
110-120	799
120-130	775
130-140	693
140-150	555
150-160	378
160-170	203
170-180	61
180	

i All IES files for other lamping are available for download at: www.axislighting.com

● **PHOTOMETRIC DATA**

L louver - Down

Uplight
0 lm/ft
Downlight
1000 lm/ft

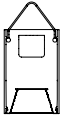

PHOTOMETRIC CURVE

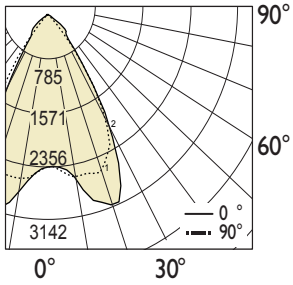

Lumen/ft up: 0 lm/ft
Lumen/ft down: 1000 lm/ft
Total Lumens: 3854 lm (for 4ft)
Input Watts: 39.6 W
Efficacy: 97 lm/W

IES FILE: TB2DILED-0-1000-80-35-L-4.IES

TESTED ACCORDING TO IES LM-79-2008

CANDELA DISTRIBUTION

Vertical Angle	Horizontal Angles				
	0	22.5	45	67.5	90
0	2297	2297	2297	2297	2297
5	2356	2348	2337	2321	2312
15	2483	2504	2693	2915	2904
25	2322	2513	3107	3055	2851
35	1290	1752	2342	1633	1320
45	194	307	658	478	428
55	32	48	76	175	250
65	6	8	13	17	20
75	2	2	3	5	5
85	0	1	1	1	1
90	0	0	0	0	0

ZONAL LUMENS

Zone	Lumens
0	
0-10	228
10-20	768
20-30	1260
30-40	1073
40-50	397
50-60	106
60-70	19
70-80	4
80-90	1
90	

LUMINANCE DATA (cd/m²)

Vertical Angle	Horizontal Angles		
	0	45	90
45	4597	15642	10171
55	949	2223	7334
65	219	521	807
75	110	208	312
85	77	154	212

i All IES files for other lamping are available for download at: www.axislighting.com

● **PHOTOMETRIC DATA**

SL SurroundLite - Up
SO spotless lens - Down

Uplight
400 lm/ft
Downlight
400 lm/ft

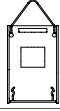

PHOTOMETRIC CURVE

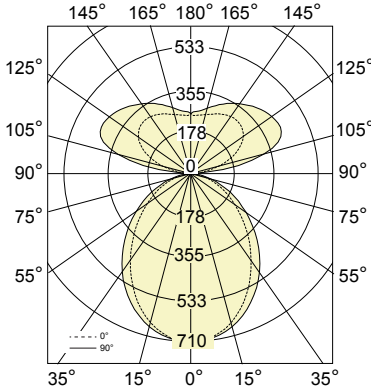

Lumen/ft up: 1600 lm/ft
Lumen/ft down: 1600 lm/ft
Total Lumens: 3200 lm (for 4ft)
Input Watts: 28.8 W
Efficacy: 111 lm/W

IES FILE: TB2DILED-400-400-80-35-SL-SO-4.IES

TESTED ACCORDING TO IES LM-79-2008

CANDELA DISTRIBUTION

Vertical Angle	Horizontal Angles				
	0	22.5	45	67.5	90
0	710	710	710	710	710
5	704	704	705	706	706
15	652	654	660	667	669
25	560	565	580	594	600
35	445	454	475	497	505
45	331	340	363	387	396
55	228	236	256	278	285
65	141	147	162	177	182
75	72	75	82	91	94
85	17	18	21	24	25
90	2	1	2	2	2
95	25	45	56	64	56
105	121	148	205	287	319
115	212	235	286	371	422
125	270	291	328	386	420
135	295	312	339	375	394
145	295	306	330	352	361
155	278	286	306	320	325
165	259	265	279	285	288
175	248	252	263	264	264
180	254	254	254	254	254

ZONAL LUMENS

Zone	Lumens
0	
0-10	67
10-20	186
20-30	267
30-40	297
40-50	280
50-60	230
60-70	161
70-80	88
80-90	24
90	
90-100	63
100-110	223
110-120	297
120-130	301
130-140	265
140-150	207
150-160	141
160-170	79
170-180	25
180	

LUMINANCE DATA (cd/m²)

Vertical Angle	Horizontal Angles		
	0	45	90
45	7795	8554	9323
55	6633	7444	8280
65	5577	6378	7182
75	4606	5299	6029
85	3275	3930	4866

SL SurroundLite - Up
SO spotless lens - Down

Uplight
1100 lm/ft
Downlight
400 lm/ft

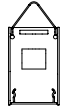

PHOTOMETRIC CURVE

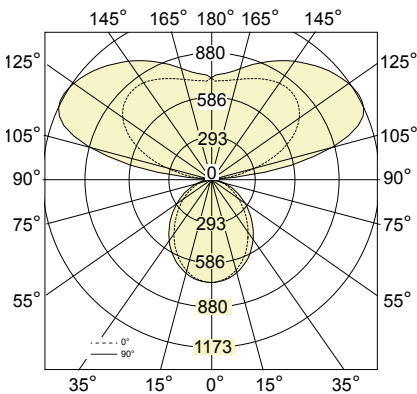

Lumen/ft up: 4400 lm/ft
Lumen/ft down: 1600 lm/ft
Total Lumens: 6000 lm (for 4ft)
Input Watts: 54.05 W
Efficacy: 111 lm/W

IES FILE: TB2DILED-1100-400-80-35-SL-SO-4.IES

TESTED ACCORDING TO IES LM-79-2008

CANDELA DISTRIBUTION

Vertical Angle	Horizontal Angles				
	0	22.5	45	67.5	90
0	710	710	710	710	710
5	704	704	705	706	706
15	652	654	660	667	669
25	560	565	580	594	600
35	445	454	475	497	505
45	331	340	363	387	396
55	228	236	256	278	285
65	141	147	162	177	182
75	72	75	82	91	94
85	17	18	21	24	25
90	4	3	3	3	4
95	68	124	155	175	154
105	331	408	564	790	876
115	583	645	785	1020	1162
125	744	800	901	1061	1154
135	812	857	933	1032	1083
145	811	842	907	967	993
155	765	787	841	880	894
165	712	728	768	785	792
175	681	692	723	725	726
180	700	700	700	700	700

ZONAL LUMENS

Zone	Lumens
0	
0-10	67
10-20	186
20-30	267
30-40	297
40-50	280
50-60	230
60-70	161
70-80	88
80-90	25
90	
90-100	174
100-110	613
110-120	817
120-130	828
130-140	728
140-150	568
150-160	387
160-170	216
170-180	68
180	

LUMINANCE DATA (cd/m²)

Vertical Angle	Horizontal Angles		
	0	45	90
45	7795	8554	9323
55	6633	7444	8280
65	5577	6378	7182
75	4606	5299	6029
85	3275	3930	4866

i All IES files for other lamping are available for download at: www.axislighting.com

● PHOTOMETRIC DATA

SL SurroundLite - Up
SO spotless lens - Down

Uplight
1100 lm/ft
Downlight
1000 lm/ft

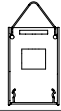

PHOTOMETRIC CURVE

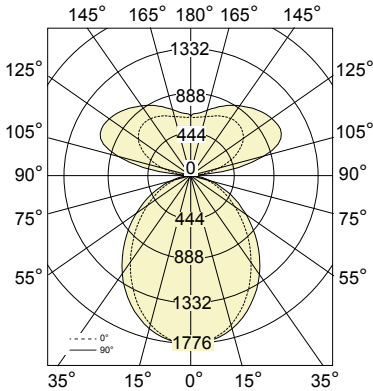

Lumen/ft up: 4000 lm/ft
Lumen/ft down: 4400 lm/ft
Total Lumens: 8399 lm (for 4ft)
Input Watts: 75.6 W
Efficacy: 111 lm/W

IES FILE: TB2DILED1100-1000-80-35-SL-SO-4.IES

TESTED ACCORDING TO IES LM-79-2008

CANDELA DISTRIBUTION

Vertical Angle	Horizontal Angles				
	0	22.5	45	67.5	90
0	1776	1776	1776	1776	1776
5	1760	1760	1762	1764	1765
15	1630	1636	1651	1668	1673
25	1399	1414	1449	1486	1500
35	1113	1134	1188	1242	1263
45	827	850	908	968	989
55	571	591	641	694	713
65	354	368	404	443	455
75	179	186	206	227	234
85	43	45	51	60	64
90	5	3	4	4	6
95	68	124	155	175	154
105	331	408	564	790	876
115	583	645	785	1020	1162
125	744	800	901	1061	1154
135	812	857	933	1032	1083
145	811	842	907	967	993
155	765	787	841	880	894
165	712	728	768	785	792
175	681	692	723	725	726
180	700	700	700	700	700

ZONAL LUMENS

Zone	Lumens
0	
0-10	167
10-20	465
20-30	666
30-40	742
40-50	701
50-60	575
60-70	403
70-80	220
80-90	61
90	
90-100	174
100-110	613
110-120	817
120-130	828
130-140	728
140-150	568
150-160	387
160-170	216
170-180	68
180	

LUMINANCE DATA (cd/m²)

Vertical Angle	Horizontal Angles		
	0	45	90
45	19487	21386	23308
55	16583	18609	20700
65	13943	15945	17955
75	11515	13248	15073
85	8188	9825	12165

SL SurroundLite - Up
SO spotless lens - Down

Uplight
400 lm/ft
Downlight
1000 lm/ft

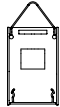

PHOTOMETRIC CURVE

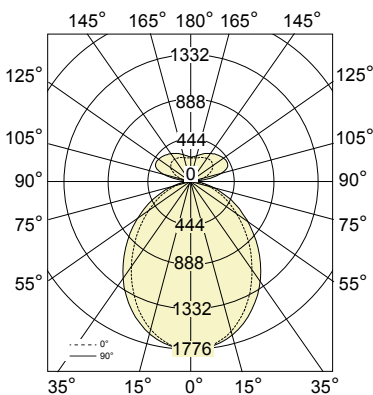

Lumen/ft up: 1600 lm/ft
Lumen/ft down: 3999 lm/ft
Total Lumens: 5599 lm (for 4ft)
Input Watts: 50.4 W
Efficacy: 111 lm/W

IES FILE: TB2DILED-400-1000-80-35-SL-SO-4.IES

TESTED ACCORDING TO IES LM-79-2008

CANDELA DISTRIBUTION

Vertical Angle	Horizontal Angles				
	0	22.5	45	67.5	90
0	1776	1776	1776	1776	1776
5	1760	1760	1762	1764	1765
15	1630	1636	1651	1668	1673
25	1399	1414	1449	1486	1500
35	1113	1134	1188	1242	1263
45	827	850	908	968	989
55	571	591	641	694	713
65	354	368	404	443	455
75	179	186	206	227	234
85	43	45	51	60	64
90	3	2	3	2	4
95	25	45	56	64	56
105	121	148	205	287	319
115	212	235	286	371	422
125	270	291	328	386	420
135	295	312	339	375	394
145	295	306	330	352	361
155	278	286	306	320	325
165	259	265	279	285	288
175	248	252	263	264	264
180	254	254	254	254	254

ZONAL LUMENS

Zone	Lumens
0	
0-10	167
10-20	465
20-30	666
30-40	742
40-50	701
50-60	575
60-70	403
70-80	220
80-90	61
90	
90-100	63
100-110	223
110-120	297
120-130	301
130-140	265
140-150	207
150-160	141
160-170	79
170-180	25
180	

LUMINANCE DATA (cd/m²)

Vertical Angle	Horizontal Angles		
	0	45	90
45	19487	21386	23308
55	16583	18609	20700
65	13943	15945	17955
75	11515	13248	15073
85	8188	9825	12165

i All IES files for other lamping are available for download at: www.axislighting.com