

Flat end cap shown

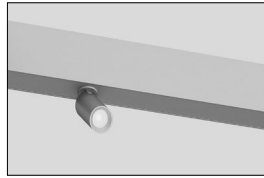

Accent shown

Project \_\_\_\_\_

Type \_\_\_\_\_

Notes \_\_\_\_\_

**A configuration drawing is required**

Factory is available for assistance

See page 2 for example of how to specify

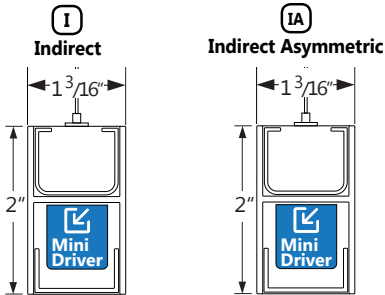

See page 4 for  
Accent section view.

### PRODUCT DIRECTORY

**NOTE:** For Hub End Caps, In-line hubs, Blank, Indirect or Accent segments please refer to the product directory code directory below.

PRODUCT ID	END CAPS		DISTRIBUTIONS				JOINING	
	HUB	FLAT	DIRECT	INDIRECT/ INDIRECT ASYM.	BLANK	ACCENTS	IN-LINE HUB	INTERNAL JOINER
STD <sup>(1)</sup>		X	X					X
STI/STIA <sup>(2)</sup>		X		X				X
STCO <sup>(3)</sup>	X		X	X	X	X	X	

<sup>(1)</sup> Stencil Pendant Direct LED Linear.

<sup>(2)</sup> Stencil Pendant Indirect/ Indirect Asymmetric LED Linear.

<sup>(3)</sup> Stencil Pendant LED Combined Distribution Linear.

### Ordering Guide

PRODUCT ID	NOM. LUMENS/FT	CRI	COLOR TEMP.	LINEAR LENGTH
<b>STI</b> Stencil Pendant Indirect LED - Linear	<b>175</b> 175 lm/ft	<b>80</b> 80 CRI	<b>27</b> 2700 K <sup>(1)</sup>	<b>2</b> 2'
<b>STIA</b> Stencil Pendant Indirect Asymmetric LED - Linear	<b>250</b> 250 lm/ft	<b>90</b> 90 CRI	<b>30</b> 3000 K	<b>3</b> 3'
	<b>350</b> 350 lm/ft		<b>35</b> 3500 K	<b>4</b> 4'
	<b>500</b> 500 lm/ft		<b>40</b> 4000 K	<b>5</b> 5'
	<b>700</b> 700 lm/ft			<b>6</b> 6'
	<b>1000</b> 1000 lm/ft			<b>7</b> 7'
				<b>8</b> 8'
				<b>S#</b> System Run <sup>(2)</sup>

All lens options use micro lens; Applies for all upright segments

(1) 10% decrease in lumen output

(2) Lit and unlit segments can be combined within the same extrusion to create other lengths.

FINISH	VOLTAGE	MD DRIVER	CIRCUITS
<b>AP</b> aluminum paint	<b>120</b> 120 V	<b>MD</b> integral mini driver 0-10V dimming 2%	<b>1</b> 1 circuit
<b>W</b> white	<b>277</b> 277 V		<b>2</b> 2 circuits
<b>BLK</b> black	<b>347</b> 347 V*		<b>+E(#)</b> emergency circuit <sup>(3)</sup>
<b>C</b> custom	<b>UNV</b> universal		

\* Consult factory

Only integral 0-10V mini driver available

(3) Specify quantity

MOUNTING/SUSPENSION	CANOPY	BATTERY - REMOTE (OPTIONAL)	CUSTOM (OPTIONAL)
<b>CA(#)</b> drywall+cable length (36" std.)	<b>RC</b> round canopy	<b>B#</b> remote battery pack	<b>C</b> custom
<b>CT9(#)</b> TB/TG 9/16+cable length (36" std.)	<b>SC</b> square canopy		
<b>CT15(#)</b> TB/TG15/16+cable length (36" std.)			
<b>CTS(#)</b> ST+cable length (36" std.)			

Specify length

White canopy standard

Remote only  
Not available with 347V  
Please consult factory

Please specify

### Ordering Guide-Accent Only (Optional)

ACCENT QUANTITY	BEAM	ACCENT FINISH
<b>AC(#)</b> accent quantity	<b>D20</b> 20 deg	<b>AP</b> aluminum paint
	<b>D35</b> 35 deg	<b>W</b> white
		<b>BLK</b> black

Only available in 500 lumens, 3000 K, 80 CRI with 0-10V dimming (5%).  
Minimum spacing between Accents is 6".  
Accent provided on blank section by default (min length 3').  
Also compatible with indirect segments (min length 6').  
See page 4 for more information.

## How to Specify Total Linear Length, Distributions

### Example

**I** Indirect   **IA** Indirect Asymmetric   **B** Blank   **AC** Accent

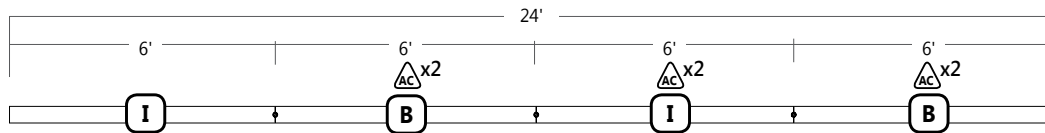

1. Specify Total Length - Indirect

**I12**  
TOTAL LENGTH\* - INDIRECT

**I**

2. Specify Total Length - Blank

**B12**  
TOTAL LENGTH\*\* - BLANK

**B**

3. Specify Accent Quantity  
(if necessary)

**AC6**  
ACCENT QTY

**AC**

-Minimum segment length for Accents is 6'.

\*Segment length from 2' to 8' continuous in one foot increments. Specify total linear length of each distribution.

\*\*Blank segments: available in any length; min 7", max 8'.

Linear Forms Indirect (Flat Endcap)				
Mounting points X1		Total length X2		
Feet	Inches	mm	Inches	mm
2	24	610	24.57	625
3	36.87	940	37.45	950
4	48	1220	48.57	1235
5	59.12	1500	59.7	1515
6	72	1830	72.57	1845
7	83.12	2110	83.7	2125
8	96	2440	96.57	2450

 25W Driver only

**X1 - Total length**  
**X2 - Mounting points**

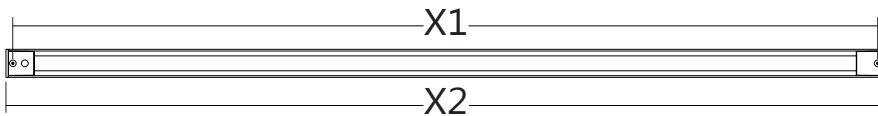

● **SYSTEM (S#)**

Stencil Pendant Indirect Linear is available in standalone lit segments in lengths from 2' to 8' in one foot increments. Stencil linear is also available in continuous lines of light for lengths that are greater than 8'. Those are designated as systems (S#) where "#" is the desired length. This means that system runs are comprised of a combination of lengths to be assembled on site and made possible through the use of the Stencil Indirect Joiner seen below.

**JOINING SYSTEM**

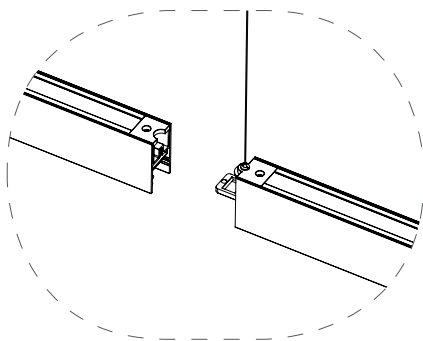
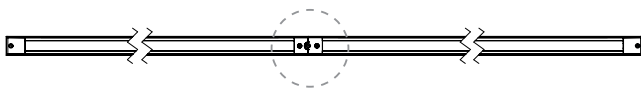

**ROW CONFIGURATION LENGTH EXAMPLE 24'**

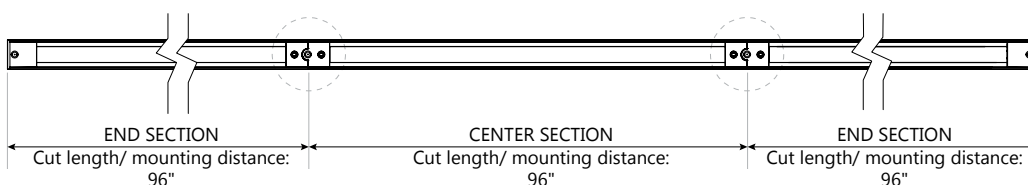

**i** For more information on systems and joining, please refer to the Stencil installation sheets available for download at [www.axislighting.com](http://www.axislighting.com). For lengths not listed or different length combinations, please consult factory.

### ● LED SYSTEM

<b>CRI</b>	Minimum 80 or 90 color rendering index
<b>CCT</b>	Choice of 2700K, 3000K, 3500K and 4000K color temperature with a great color consistency (within 3.0-step MacAdam ellipse).
<b>LED life</b>	Minimum 50,000h with 85% of lumen maintenance in 25°C ambient temperature, in compliance with IES LM-80 testing measurements.
<b>Thermal Management</b>	Aluminum housing acting as the heat sink to maximize life.
<b>Performance</b>	Up to 101 lm/W.

### ● CONSTRUCTION

<b>Housing</b>	Extruded Aluminum (0.080" nominal) up to
<b>End Cap+Joiner</b>	Die Cast Aluminum
<b>Interior Brackets</b>	Die Formed Sheet Steel (20 gauge)
<b>Reflectors</b>	White Powder Coated Sheet Steel (22 gauge)
<b>Lenses</b>	Extruded Acrylic
<b>Hanger</b>	Die Cast Aluminum
<b>Suspension</b>	Aircraft Cable along product length
<b>Cable Grips</b>	Quick Connecting / Release

### ● ELECTRICAL

<b>Mini driver</b>	STENCIL features integral mini driver technology. 0-10V dimming standard.
<b>Emergency</b>	Remote emergency battery pack or emergency circuit optional.
<b>Input Voltage</b>	120V, 277V, UNV.

**i** Incorporating these components may have limitations or effect the length of the luminaire, please contact factory for more details.

### ● WARRANTY

Axis lighting will warrant defective LEDs, boards, and drivers for 5 years from date of purchase. Warranty is valid if luminaire is installed and used according to specifications. If defective, Axis will send replacement boards or drivers at no cost along with detailed replacement instructions and instructions on how to return defective components to Axis.

### ● FINISH

Aluminum paint, powder coated and custom finishes are also available.

### ● APPROVALS

Certified to UL and CSA standards. Suitable for damp locations.



### ● LIGHT GUIDE

High precision light guide made of PMMA material, allows distribution of controlled light in all 3-dimensions to put light on both vertical and horizontal planes within the space. Patented lightguide design featuring molecular optics and precision-coupled optic components yield a high efficiency luminaire. In-plane mixing maximizes color uniformity while light emitting area is uniform and diffuse without 'head lighting' from the LED's.

### ● END CAPS

Continuous lines of light include flat end caps.

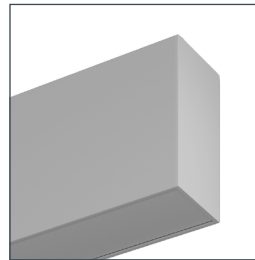

Flat End Cap

### ● STENCIL WITH ACCENT SECTION VIEW

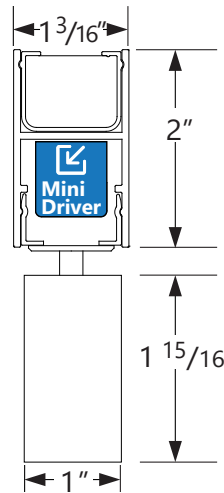

#### ACCENT EFFICACY

<b>3 Accents / Driver</b>	120V, 21W, 0.18A; 277V, 21.5W, 0.10A.
<b>1 Accent / Driver</b>	120V, 8W, 0.12A; 277V, 8.4W, 0.06A.

**NOTE:** Configuration of multiple accents with different drivers will change efficacy values.



### ● PHOTOMETRIC DATA - INDIRECT

700 lm/ft

#### PHOTOMETRIC CURVE

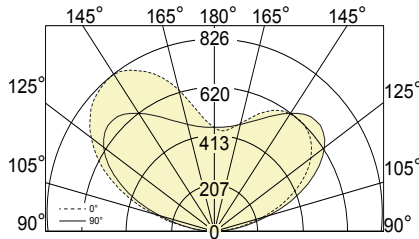

**Indirect Output: 700 lm/ft**  
**Total Lumens: 2691 lm (for 4ft)**  
**Input Watts: 31 W**  
**Efficacy: 87 lm/W**

80 CRI shown. For 90 CRI, divide wattage by 0.8 and multiply efficacy by 0.8.  
 IES FILE: STI-700-80-35-4.IES  
 TESTED ACCORDING TO IES LM-79-2008

#### CANDELA DISTRIBUTION

Vertical Angle	Horizontal Angles								
	0	22.5	45	67.5	90	112.5	135	157.5	180
90	0	0	0	0	0	0	0	0	0
95	25	26	32	42	54	65	53	41	34
105	226	211	194	215	267	265	255	278	285
115	418	391	360	394	481	472	470	520	534
125	551	520	481	518	628	639	648	695	699
135	615	585	548	572	672	732	762	795	794
145	618	595	562	554	619	719	789	823	820
155	568	548	516	498	534	627	704	748	757
165	482	469	454	451	475	529	578	620	626
175	434	433	434	438	449	465	476	483	483
180	446	446	446	446	446	446	446	446	446

#### ZONAL LUMENS

Zone	Lumens
90	
90-100	57
100-110	256
110-120	438
120-130	529
130-140	517
140-150	421
150-160	281
160-170	148
170-180	44
180	

800 lm/ft

#### PHOTOMETRIC CURVE

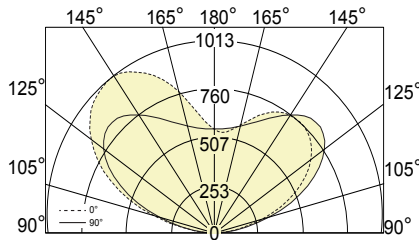

**Indirect Output: 800 lm/ft**  
**Total Lumens: 3308 lm (for 4ft)**  
**Input Watts: 38.6 W**  
**Efficacy: 86 lm/W**

80 CRI shown. For 90 CRI, divide wattage by 0.8 and multiply efficacy by 0.8.  
 IES FILE: STI-800-80-35-4.IES  
 TESTED ACCORDING TO IES LM-79-2008

#### CANDELA DISTRIBUTION

Vertical Angle	Horizontal Angles								
	0	22.5	45	67.5	90	112.5	135	157.5	180
90	0	0	0	0	0	0	0	0	0
95	61	59	61	61	67	68	42	24	18
105	319	295	263	279	329	308	283	294	299
115	547	510	462	498	592	564	551	602	617
125	697	657	605	649	774	774	777	831	834
135	764	725	679	712	832	898	928	966	962
145	755	726	686	683	771	897	977	1012	1006
155	683	659	622	610	670	794	889	939	947
165	575	562	549	555	597	672	738	792	798
175	532	533	537	546	564	587	604	612	612
180	560	560	560	560	560	560	560	560	560

#### ZONAL LUMENS

Zone	Lumens
90	
90-100	69
100-110	311
110-120	536
120-130	649
130-140	636
140-150	519
150-160	348
160-170	184
170-180	55
180	

**i** All IES files are available for download at: [www.axislighting.com](http://www.axislighting.com)

### ● PHOTOMETRIC DATA - INDIRECT

1000 lm/ft

#### PHOTOMETRIC CURVE

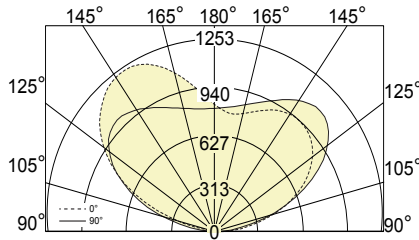

**Indirect Output: 1000 lm/ft**  
**Total Lumens: 4086 lm (for 4ft)**  
**Input Watts: 47.7 W**  
**Efficacy: 86 lm/W**

80 CRI shown. For 90 CRI, divide wattage by 0.8 and multiply efficacy by 0.8.  
 IES FILE: STI-1000-80-35-4.IES  
 TESTED ACCORDING TO IES LM-79-2008

#### CANDELA DISTRIBUTION

Vertical Angle	Horizontal Angles								
	0	22.5	45	67.5	90	112.5	135	157.5	180
90	0	0	0	0	0	0	0	0	0
95	86	9	13	34	30	45	27	17	14
105	361	244	240	272	320	305	304	339	359
115	616	515	504	563	659	625	627	696	731
125	795	733	719	788	920	896	906	973	1000
135	889	868	854	910	1049	1070	1097	1151	1165
145	911	926	909	933	1026	1111	1178	1226	1236
155	866	909	891	886	934	1030	1124	1182	1192
165	795	845	833	828	854	912	977	1022	1036
175	769	793	793	797	807	823	840	853	857
180	798	798	798	798	798	798	798	798	798

#### ZONAL LUMENS

Zone	Lumens
90	
90-100	90
100-110	372
110-120	640
120-130	781
130-140	775
140-150	648
150-160	452
160-170	251
170-180	78
180	

### ● PHOTOMETRIC DATA - INDIRECT - ASYMMETRIC

1000 lm/ft

#### PHOTOMETRIC CURVE

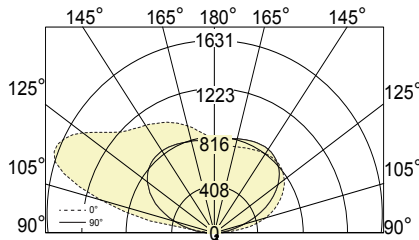

**Lumen/ft up: 1000 lm/ft**  
**Total Lumens: 4300 lm (for 4ft)**  
**Input Watts: 47.7 W**  
**Efficacy: 90 lm/W**

80 CRI shown. For 90 CRI, divide wattage by 0.8 and multiply efficacy by 0.8.  
 IES FILE: STIA-1000-80-35-AS-4.IES  
 TESTED ACCORDING TO IES LM-79-2008

#### CANDELA DISTRIBUTION

Vertical Angle	Horizontal Angles								
	0	22.5	45	67.5	90	112.5	135	157.5	180
90	0	0	0	0	0	0	0	0	0
95	125	18	24	41	30	63	33	23	20
105	479	351	331	299	263	356	605	1034	1088
115	673	597	563	534	523	604	801	1385	1631
125	789	752	719	707	717	792	925	1265	1484
135	837	833	801	801	828	896	996	1140	1217
145	823	844	826	832	868	935	1010	1087	1114
155	789	822	814	824	857	917	978	1025	1039
165	760	791	792	802	827	863	902	931	940
175	768	781	784	790	800	812	822	831	834
180	794	794	794	794	794	794	794	794	794

#### ZONAL LUMENS

Zone	Lumens
90	
90-100	159
100-110	575
110-120	777
120-130	788
130-140	706
140-150	573
150-160	408
160-170	237
170-180	77
180	

**i** All IES files are available for download at: [www.axislighting.com](http://www.axislighting.com)