

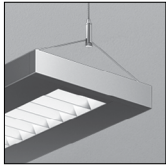

Shown with VL optic

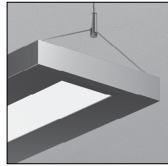

Shown with louver



Shown with SM lens

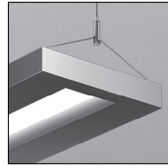

Shown regressed

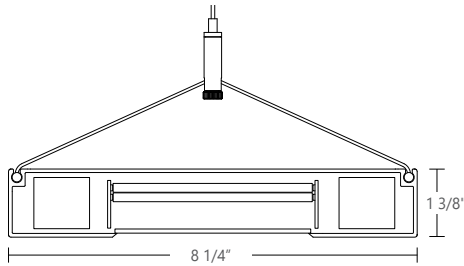

Project _____

Type _____

Notes _____

PERFORMANCE PER LINEAR FOOT AT 3500K

DISTRIBUTION	NOMINAL LUMEN OUTPUT		INPUT WATTS	EFFICACY
	UP	DOWN		
80up/20down at 1500 lm/ft	1227 lm/ft	307 lm/ft	51 W	118 lm/W
80up/20down at 1000 lm/ft	800 lm/ft	200 lm/ft	42 W	98 lm/W
80up/20down at 800 lm/ft	640 lm/ft	160 lm/ft	33 W	98 lm/W

REFER TO PHOTOMETRIC DATA SECTION FOR EXACT VALUES



Ordering Guide

SLLED		SL 80/20		NOMINAL LUMENS/FT		CRI		COLOR TEMP.	
PRODUCT ID		LIGHT ENGINE							
SLLED	Pendant LED	SL 80/20	surroundlite 80%up/20%down	600	600 lm/ft	80	80 CRI	30	3000 K
				800	800 lm/ft	90	90 CRI	35	3500 K
				1000	1000 lm/ft			40	4000 K
				1500	1500 lm/ft				
				Applies to both UP & DOWN. Consult factory for other lumen packages		Applies to both UP & DOWN.		Consult Axitune spec sheet for Axis color technology options Applies to both UP & DOWN.	

SHIELDING		FIXTURE LENGTH		FINISH		VOLTAGE		DRIVER	
VL	VL optic	4	4'	AP	aluminum paint	120	120 V	DP	dimming (0-10V) 1%
PL	flat-blade louvers	8	8'	W	white	277	277 V	LT	Lutron (2)
SM	smooth lens	12	12'	BLK	black	347	347 V (1)	BI	bi-level dimming
RE	regressed	S#	system run	C	custom	UNV	universal	O	other (3)
						Applies to both UP & DOWN. (1) Consult factory		Applies to both UP & DOWN. (2) Specify system (3) Please consult factory; see page 2 Consult Axitune spec sheet for Axis color driver options	

CIRCUITS		MOUNTING/SUSPENSION		BATTERY (OPTIONAL)		OTHER		IC CONTROLS		CUSTOM	
1	1 circuit (4)	CA(#)	drywall+cable length (36" std.)	B#	battery pack (integral)	F	fuse	DS#	daylight sensor	C	custom
2	2 circuits	CT9(#)	TB/TG 9/16+cable length (36" std.)					OS#	occupancy sensor		
2A/B	2 circuit alternating/4ft	CT15(#)	TB/TG 15/16+cable length (36" std.)					DOS#	daylight & occupancy sensor		
+E(#)	emergency section	CTS(#)	ST+cable length (36" std.)					EN#	Enlighted integral		
+NL(#)	night light section	SA(#)	drywall+stem length >48" (18" std.)					ENR#	Enlighted remote		
+GTD(#)	generator transfer device	+SM	seismic option					WC#	wireless control dimming		
(4) Control UP & DOWN lights together		See Ceiling Mount Guide for further details		For minimum 36" long fixture only Not available with 347V Please consult factory		Requires 120V or 277V		Applies to both UP & DOWN. Specify quantity. Requires 8" blank See integrated controls guide for more details.		Please specify	



● SURROUNDLITE TECHNOLOGY

SLIM with SurroundLite provides the flexibility of high efficacy spherical three dimensional wide batwing distributions and shielding options that all result in true lighting effectiveness. Slim is only 1.375" depth with integral driver and a light guide with proper cutoff and no view of bugs or dust particles.

An innovative technology to get much more out of LEDs: Axis SurroundLite is based on the fundamental physics of how light interacts with matter. The specially engineered lightguide is made of precisely coded and aligned molecules that shape LED output in all three dimensions.

With SurroundLite extra-wide, multidimensional light distribution, light is directed in all three planes and sent in every corner of the room. SurroundLite brings the promise of balanced brightness, facilitating lighting design.

3D Polar Curve (SL 80/20)

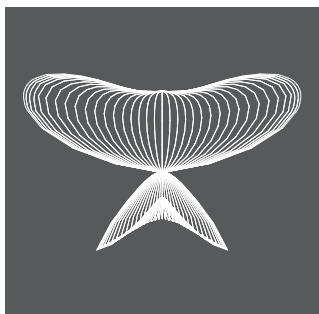

● SURROUNDLITE BENEFITS



Glare Mitigation

Regressed lens, VL Optic, louvers and lenses yield lower luminance on the luminaire's light-emitting area.

Reduced 'Cave Effect', Increased Perceived Brightness

Wide 3D batwing uplight distribution lights up corners
Lighting at seam between ceiling and wall
3D light distribution from luminaire extremities lights up adjacent spaces and vertical planes

Use of Fewer Luminaires

The 3D nature of light distribution is well suited to checkerboard patterns, reducing the need for continuous rows.

Better Facial Modeling / Facial Recognition

Reflected light from illuminated surfaces within the space results in soft fill light on the vertical plane.

No Streaks or Hot Spots of Light

Axis SurroundLite technology spreads out light uniformly versus Lambertian distributions that put an intensity of light directly above and below the luminaire.



● LIGHT GUIDE

High precision light guide made of PMMA material, allows distribution of controlled light in all 3-dimensions to put light on both vertical and horizontal planes within the space. Patented lightguide design featuring molecular optics and precision-coupled optic components yield a high efficiency luminaire. In-plane mixing maximizes color uniformity while light emitting area is uniform and diffuse without 'head lighting' from the LED's.

● OPTICS

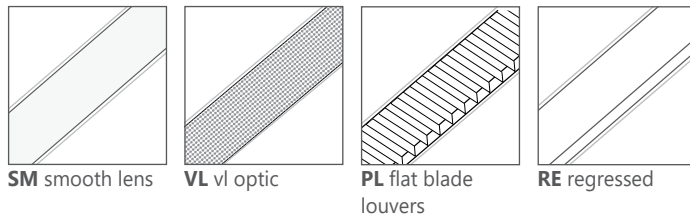

SM smooth lens

VL vl optic

PL flat blade
louvers

RE regressed

● LENGTHS

SLIM SurroundLite 4ft (4)

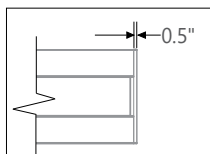
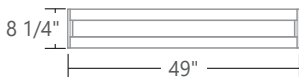

Joining detail for all system run

SLIM SurroundLite 8ft Continuous (with 8ft shielding)

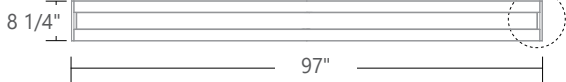

SLIM SurroundLite 12ft (with 12ft shielding)

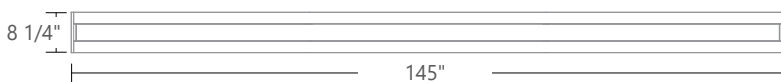

● SYSTEMS (S#)

Runs of SLIM SurroundLite that are greater than 12ft in length are designated as systems (S#). This means that the run is comprised of a combination 4ft and/or 8ft sections to be assembled on site using our joining system. For more information on systems and joining, please refer to the SLIM SurroundLite installation sheets available at: www.axislighting.com under 'Downloads' tab.

● WEIGHT

SLIM SurroundLite 4 ft	12 lbs / 5.4 kg
SLIM SurroundLite 8 ft	24 lbs / 10.9 kg
SLIM SurroundLite 12 ft	36 lbs / 16.3 kg

● SUSPENSION / MOUNTING SPACING

Distance Between Mounting Points:
SLIM SL 4ft 48"
SLIM SL 8ft 96"

Standard Suspension Length (Adjustable):
CABLE: 36"
STEM: 18" (For 8' length maximum)

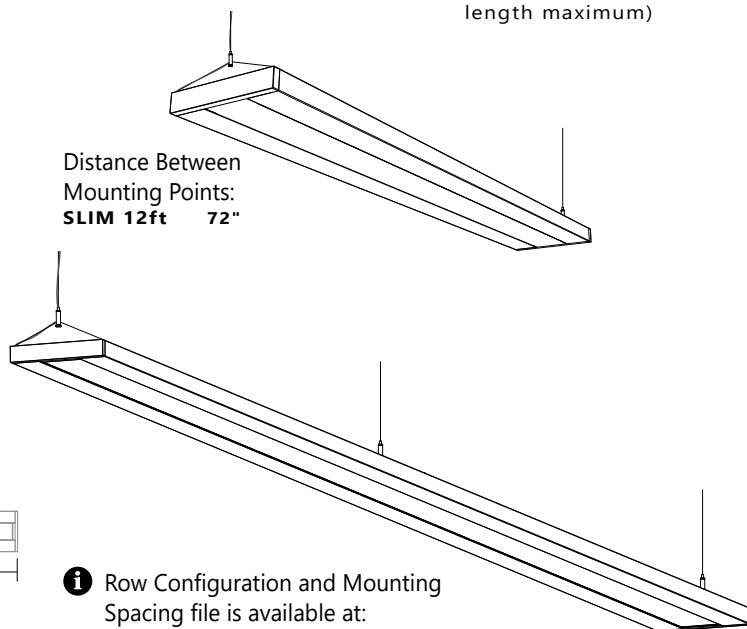

i Row Configuration and Mounting Spacing file is available at: www.axislighting.com under 'Downloads' tab.

● FINISH

Aluminum paint, powder coated and custom finishes are also available.

● APPROVALS

Certified to UL and CSA standards
 LED Lighting Facts (DOE)
 Suitable for damp locations.





● MOUNTING OPTIONS

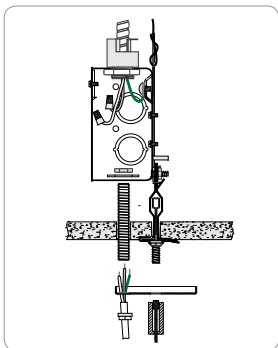

GT TILE CEILING - ON GRID

Mounting options are also available for slope ceiling and seismic bracing.

i Installation sheets for all mounting options are available at: www.axislighting.com under 'Downloads' tab.

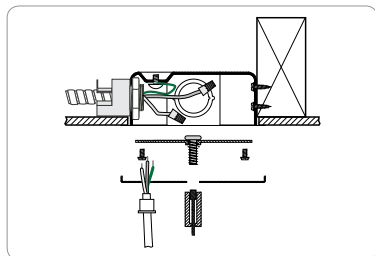

CA DRYWALL CEILING

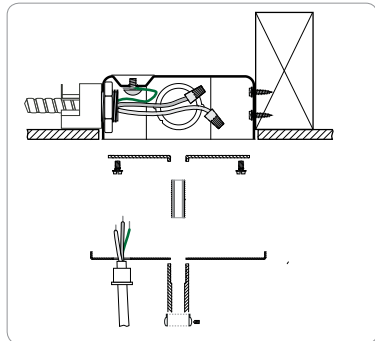

SA STEM MOUNT IN DRYWALL CEILING

● OTHER MOUNTING OPTIONS

SLIM SurroundLite is also available as a wall mount.

i Specification sheets for pendant mounted SLIM luminaires are available at: www.axislighting.com under 'Downloads' tab.

● LED UPGRADE / REPLACEMENT

All LED light engines used are field replaceable and upgradable to ensure the lighting system will last for years. Future-proof design comes with easy access to LED light engines from above using quick connectors (included in luminaire) and a screwdriver.

i For more information on LED light engine upgrade and replacement, please refer to the SLIM LED Light Engine Replacement sheet available at: www.axislighting.com under 'Downloads' tab.

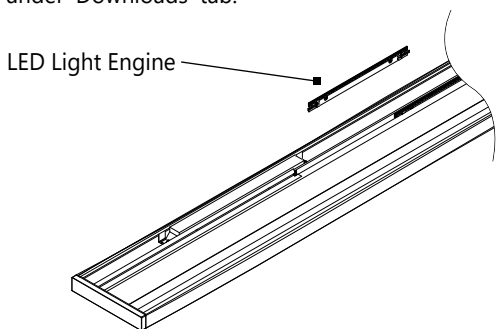

● LED SYSTEM

- CRI** Minimum 80 or 90 color rendering index
- CCT** Choice of 3000K, 3500K and 4000K color temperature with a great color consistency (within 3-step MacAdam ellipse). Both within fixture and fixture to fixture.
- LED life** Minimum 50,000h with 85% of lumen maintenance in 25°C ambient temperature, in compliance with IES LM-80 testing measurements.
- Thermal Management** Aluminum housing acting as the heat sink to maximize life.
- Environment** Dry and damp rated in operating ambient temperatures of 0-40°C (32-104F)

● CONSTRUCTION

- Housing** Extruded aluminum (0.075" nominal)
- End Cap** Die cast aluminum (0.10" nominal)
- Joiners** Die cast aluminum (0.10" nominal)
- Interior Bracket** Die formed zinc (22 gauge)
- Top Covers** Cold rolled sheet steel painted (24 gauge)
- Optic™** PMMA Precision formed microconical structure; 92 percent transmission that cuts off glare above 55 degrees
- Smooth Lens** Uniform frosted acrylic lens
- Flat blade louvers** Semispecular aluminum material (electronically anodized) for added visual comfort

● ELECTRICAL

- Lutron driver*** LDE1 - EcoSystem H-Series (1%)
LDE5 - EcoSystem 5-Series (5%)
LTE - Hi-Lume® A-series 2Wires Forward Phase (1%)
*Consult factory
- Other drivers** DALI - Digital Addressable Lighting Interface
DMX - Digital Multiplex
LV - line voltage - Advance Mark 10
Xitanium SR - For wireless sensor
- Emergency** Integral emergency battery pack or emergency circuit optional.
- Input Voltage** 120V, 277V, 347V, UNV.

i Incorporating these components may have limitations or affect the length of the luminaire. Please contact factory for more details.



PHOTOMETRIC DATA

REGRESSED (RE)

SLLED-B3-SL-80/20-1000-80-35-RE-4-4
80% up / 20% down at 1000 lm/ft

PHOTOMETRIC CURVE

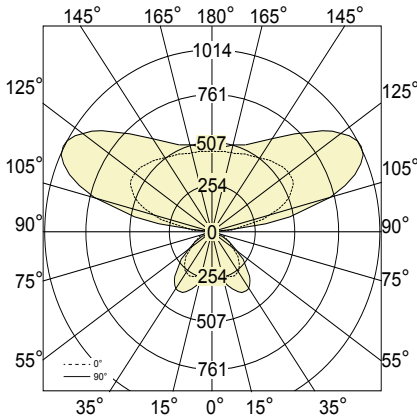

Lumen/ft up: 842 lm/ft
Lumen/ft down: 227 lm/ft
Total lumens: 4275 lm (for 4ft)
Input Watts: 42 W
Efficacy: 101 lm/W

CRI:80 shown (for CRI:90 use 0.8 multiplier on watts and efficacy)

IES FILE: SLLED-B3-SL-80-20-1000-80-35-RE-4-4-W-120-D-1.IES

TESTED ACCORDING TO IES LM-79-2008

CANDELA DISTRIBUTION

Vertical Angle	Horizontal Angles				
	0	22.5	45	67.5	90
0	217	217	217	217	217
5	219	221	222	227	228
15	244	252	266	282	287
25	274	290	322	356	366
35	275	295	334	370	384
45	224	242	263	291	303
55	148	152	158	171	176
65	86	78	76	77	76
75	40	29	23	16	11
85	3	0	0	0	0
90	0	0	0	0	0
95	115	111	125	136	137
105	370	398	499	652	732
115	532	581	717	905	1003
125	565	613	732	879	951
135	536	573	650	739	777
145	499	531	568	612	630
155	469	499	515	529	535
165	452	459	489	494	495
175	443	446	450	451	451
180	445	445	445	445	445

ZONAL LUMENS

Zone	Lumens
0	
0-10	22
10-20	77
20-30	149
30-40	206
40-50	203
50-60	144
60-70	79
70-80	26
80-90	1
90	
90-100	151
100-110	546
110-120	726
120-130	666
130-140	508
140-150	359
150-160	238
160-170	136
170-180	43
180	

LUMINANCE DATA (cd/m²)

Vertical Angle	Horizontal Angles		
	0	45	90
45	3112	3653	4209
55	2535	2706	3014
65	1999	1766	1766
75	1518	873	417
85	338	0	0

Axis Lighting

lighting facts®

A Program of the U.S. DOE

Light Output (Lumens) 4275

Watts 42.24

Lumens per Watt (Efficacy) 101

Color Accuracy 82

Color Rendering Index (CRI)

Light Color 3278 (Bright White)

Correlated Color Temperature (CCT)

2700K 3000K 4500K 6500K

LED Lumen Maintenance Projection 88.21%

at 25,000 Hours at 25°C Ambient*

Warranty** Yes

All results, except LED Lumen Maintenance, are according to IESNA LM-79-2008. Approved Method for the Electrical and Photometric Testing of Solid-State Lighting. The U.S. Department of Energy (DOE) verifies product test data and results.

* Based on TM-21 projections for the light source.
** See www.lightingfacts.com/products for details.

REGRESSED (RE)

SLLED-B3-SL-80/20-800-80-35-RE-4-4
80% up / 20% down at 800 lm/ft

PHOTOMETRIC CURVE

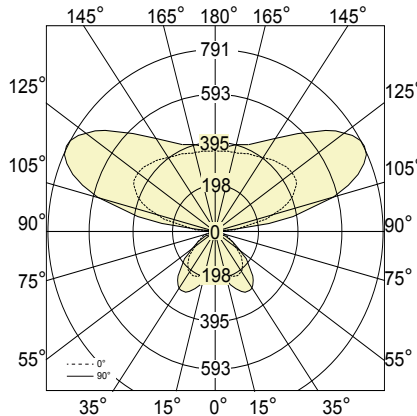

Lumen/ft up: 657 lm/ft
Lumen/ft down: 177 lm/ft
Total lumens: 3335 lm (for 4ft)
Input Watts: 33 W
Efficacy: 101 lm/W

CRI:80 shown (for CRI:90 use 0.8 multiplier on watts and efficacy)

IES FILE: SLLED-B3-SL-80-20-800-80-35-RE-4-4-W-120-D-1.IES

TESTED ACCORDING TO IES LM-79-2008

CANDELA DISTRIBUTION

Vertical Angle	Horizontal Angles				
	0	22.5	45	67.5	90
0	169	169	169	169	169
5	171	172	173	177	178
15	190	197	207	220	224
25	214	226	251	278	285
35	215	230	261	289	300
45	175	189	205	227	236
55	115	119	123	133	137
65	67	61	59	60	59
75	31	23	18	12	9
85	2	0	0	0	0
90	0	0	0	0	0
95	90	87	98	106	107
105	289	310	389	509	571
115	415	453	559	706	782
125	441	478	571	686	742
135	418	447	507	576	606
145	389	414	443	477	491
155	366	389	402	413	417
165	353	358	381	385	386
175	346	348	351	352	352
180	347	347	347	347	347

ZONAL LUMENS

Zone	Lumens
0	
0-10	17
10-20	60
20-30	116
30-40	160
40-50	158
50-60	113
60-70	61
70-80	20
80-90	1
90	
90-100	118
100-110	426
110-120	566
120-130	519
130-140	396
140-150	280
150-160	186
160-170	106
170-180	34
180	

LUMINANCE DATA (cd/m²)

Vertical Angle	Horizontal Angles		
	0	45	90
45	2427	2850	3283
55	1977	2111	2351
65	1559	1378	1378
75	1184	681	326
85	264	0	0



● PHOTOMETRIC DATA

REGRESSED (RE)

SLLED-B3-SL-80/20-1500-80-35-RE-4-4
80% up / 20% down at 1500 lm/ft

PHOTOMETRIC CURVE

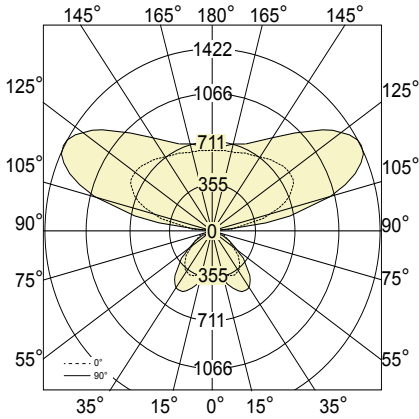

Lumen/ft up: 1227 lm/ft
Lumen/ft down: 307 lm/ft
Total lumens: 6000 lm (for 4ft)
Input Watts: 50.8 (12.7W/ft)
Efficacy: 118 lm/W

CANDELA DISTRIBUTION

Vertical Angle	Horizontal Angles				
	0	22.5	45	67.5	90
0	304	304	304	304	304
5	307	310	311	318	320
15	342	353	373	395	402
25	384	407	452	499	513
35	386	414	468	519	538
45	314	339	369	408	425
55	208	213	222	240	247
65	121	109	107	108	107
75	56	41	32	22	15
85	4	0	0	0	0
90	0	0	0	0	0
95	161	156	175	191	192
105	519	558	700	914	1026
115	746	815	1005	1269	1406
125	792	860	1026	1233	1333
135	752	803	911	1036	1090
145	700	745	796	858	883
155	658	700	722	742	750
165	634	644	686	693	694
175	621	625	631	632	632
180	624	624	624	624	624

ZONAL LUMENS

Zone	Lumens
0	
0-10	31
10-20	107
20-30	208
30-40	288
40-50	284
50-60	203
60-70	110
70-80	37
80-90	2
90	
90-100	212
100-110	765
110-120	1018
120-130	933
130-140	713
140-150	503
150-160	333
160-170	191
170-180	61
180	

LUMINANCE DATA (cd/m²)

Vertical Angle	Horizontal Angles		
	0	45	90
45	4363	5123	5902
55	3554	3794	4226
65	2803	2477	2477
75	2129	1224	585
85	474	0	0

CRI:80 shown (for CRI:90 use 0.8 multiplier on watts and efficacy)

IES FILE: SLLED-B3-SL-80-20-1500-80-35-RE-4-4-W-120-D-1.IES

TESTED ACCORDING TO IES LM-79-2008



● PHOTOMETRIC DATA

VL LENS (VL)

SLLED-B3-SL-80/20-1000-80-35-VL-4-4
80% up / 20% down at 1000 lm/ft

PHOTOMETRIC CURVE

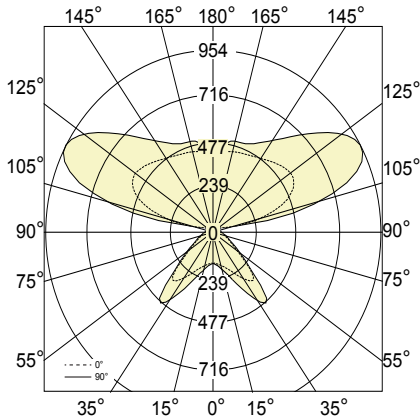

Lumen/ft up: 793 lm/ft
Lumen/ft down: 233 lm/ft
Total lumens: 4102 lm (for 4ft)
Input Watts: 42 W
Efficacy: 98 lm/W

CRI:80 shown (for CRI:90 use 0.8 multiplier on watts and efficacy)

IES FILE: SLLED-B3-SL-80-20-1000-80-35-VL-4-4-W-120-D-1.IES

TESTED ACCORDING TO IES LM-79-2008

CANDELA DISTRIBUTION

Vertical Angle	Horizontal Angles				
	0	22.5	45	67.5	90
0	184	184	184	184	184
5	185	187	188	191	192
15	205	210	218	228	231
25	250	261	286	314	322
35	330	354	400	450	473
45	299	298	303	313	309
55	119	132	137	138	137
65	61	65	64	64	67
75	31	33	32	31	33
85	8	6	7	9	4
90	0	0	0	0	0
95	114	112	123	133	128
105	364	389	485	640	709
115	508	557	683	866	949
125	529	575	678	814	874
135	492	531	588	665	696
145	456	498	514	549	563
155	433	476	482	490	493
165	420	439	468	478	478
175	409	412	414	418	418
180	409	409	409	409	409

ZONAL LUMENS

Zone	Lumens
0	
0-10	18
10-20	63
20-30	135
30-40	249
40-50	236
50-60	122
60-70	65
70-80	34
80-90	8
90	
90-100	149
100-110	532
110-120	693
120-130	619
130-140	462
140-150	327
150-160	222
160-170	130
170-180	40
180	

LUMINANCE DATA (cd/m²)

Vertical Angle	Horizontal Angles		
	0	45	90
45	4154	4209	4292
55	2038	2346	2346
65	1418	1488	1557
75	1177	1214	1252
85	902	789	451

VL LENS (VL)

SLLED-B3-SL-80/20-800-80-35-VL-4-4
80% up / 20% down at 800 lm/ft

PHOTOMETRIC CURVE

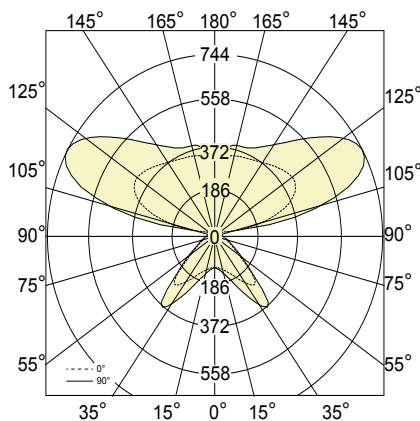

Lumen/ft up: 618 lm/ft
Lumen/ft down: 182 lm/ft
Total lumens: 3200 lm (for 4ft)
Input Watts: 33 W
Efficacy: 98 lm/W

CRI:80 shown (for CRI:90 use 0.8 multiplier on watts and efficacy)

IES FILE: SLLED-B3-SL-80-20-800-80-35-VL-4-4-W-120-D-1.IES

TESTED ACCORDING TO IES LM-79-2008

CANDELA DISTRIBUTION

Vertical Angle	Horizontal Angles				
	0	22.5	45	67.5	90
0	144	144	144	144	144
5	144	146	147	149	150
15	160	164	170	178	180
25	195	204	223	245	251
35	257	276	312	351	369
45	233	232	236	244	241
55	93	103	107	108	107
65	48	51	50	50	52
75	24	26	25	24	26
85	6	5	5	7	3
90	0	0	0	0	0
95	89	87	96	104	100
105	284	303	378	499	553
115	396	434	533	675	740
125	413	449	529	635	682
135	384	414	459	519	543
145	356	388	401	428	439
155	338	371	376	382	385
165	328	342	365	373	373
175	319	321	323	326	326
180	319	319	319	319	319

ZONAL LUMENS

Zone	Lumens
0	
0-10	14
10-20	49
20-30	106
30-40	194
40-50	184
50-60	95
60-70	50
70-80	26
80-90	7
90	
90-100	117
100-110	415
110-120	540
120-130	483
130-140	361
140-150	255
150-160	173
160-170	101
170-180	32
180	

LUMINANCE DATA (cd/m²)

Vertical Angle	Horizontal Angles		
	0	45	90
45	3240	3283	3348
55	1590	1830	1830
65	1106	1160	1215
75	918	947	977
85	703	615	352



● PHOTOMETRIC DATA

VL LENS (VL)

SLLLED-B3-SL-80/20-1500-80-35-VL-4-4
80% up / 20% down at 1500 lm/ft

PHOTOMETRIC CURVE

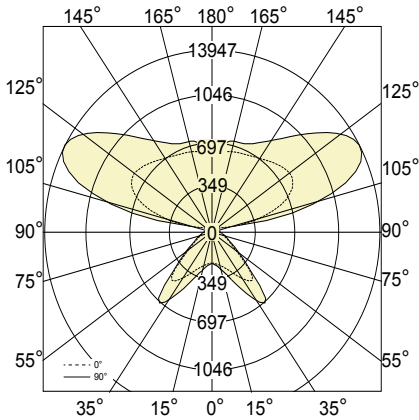

Lumen/ft up: 1227 lm/ft
Lumen/ft down: 307 lm/ft
Total lumens: 6000 lm (for 4ft)
Input Watts: 53.1 W (13.3W/ft)
Efficacy: 113 lm/W

CANDELA DISTRIBUTION

Vertical Angle	Horizontal Angles				
	0	22.5	45	67.5	90
0	269	269	269	269	269
5	270	273	275	279	281
15	300	307	319	333	338
25	365	381	418	459	471
35	482	517	585	658	691
45	437	436	443	457	452
55	174	193	200	202	200
65	89	95	94	94	98
75	45	48	47	45	48
85	12	9	10	13	6
90	0	0	0	0	0
95	167	164	180	194	187
105	532	569	709	935	1036
115	743	814	998	1266	1387
125	773	840	991	1190	1277
135	719	776	859	972	1017
145	667	728	751	802	823
155	633	696	705	716	721
165	614	642	684	699	699
175	598	602	605	611	611
180	598	598	598	598	598

ZONAL LUMENS

Zone	Lumens
0	
0-10	27
10-20	92
20-30	198
30-40	364
40-50	345
50-60	178
60-70	94
70-80	49
80-90	12
90	
90-100	218
100-110	777
110-120	1013
120-130	904
130-140	676
140-150	478
150-160	325
160-170	190
170-180	59
180	

LUMINANCE DATA (cd/m²)

Vertical Angle	Horizontal Angles		
	0	45	90
45	6071	6152	6274
55	2979	3429	3429
65	2072	2174	2276
75	1720	1775	1831
85	1318	1153	659

CRI:80 shown (for CRI:90 use 0.8 multiplier on watts and efficacy)

IES FILE: SLLLED-B3-SL-80-20-1500-80-35-VL-4-4-W-120-D-1.IES

TESTED ACCORDING TO IES LM-79-2008



● PHOTOMETRIC DATA

FLAT-BLADE LOUVER (PL)

SLLED-B3-SL-80/20-1000-80-35-PL-4-4
80% up / 20% down at 1000 lm/ft

PHOTOMETRIC CURVE

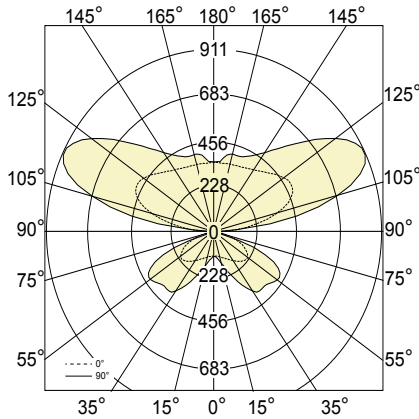

Lumen/ft up: 728 lm/ft
Lumen/ft down: 284 lm/ft
Total lumens: 4046 lm (for 4ft)
Input Watts: 42 W
Efficacy: 97 lm/W

CRI:80 shown (for CRI:90 use 0.8 multiplier on watts and efficacy)
IES FILE: SLLED-B3-SL-80-20-1000-80-35-PL-4-4-W-120-D-1.IES

TESTED ACCORDING TO IES LM-79-2008

CANDELA DISTRIBUTION

Vertical Angle	Horizontal Angles				
	0	22.5	45	67.5	90
0	123	124	125	128	129
5	130	136	148	164	170
15	148	161	194	236	256
25	175	197	254	322	363
35	208	239	303	353	387
45	223	253	301	358	421
55	180	192	219	279	357
65	94	88	74	49	38
75	12	5	0	0	0
85	0	0	0	0	0
90	115	112	126	136	130
95	350	376	475	627	693
105	474	523	648	830	911
115	471	518	621	758	817
125	420	458	518	596	626
135	380	418	439	476	488
145	359	401	404	415	418
155	351	365	397	404	403
165	348	350	352	356	355
175	350	350	350	350	350
180	445	445	445	445	445

ZONAL LUMENS

Zone	Lumens
0	
0-10	12
10-20	43
20-30	93
30-40	164
40-50	230
50-60	273
60-70	232
70-80	83
80-90	6
90	
90-100	151
100-110	518
110-120	658
120-130	568
130-140	408
140-150	279
150-160	187
160-170	109
170-180	34
180	

LUMINANCE DATA (cd/m²)

Vertical Angle	Horizontal Angles		
	0	45	90
45	2883	4211	5380
55	3806	5166	7227
65	4172	5096	8306
75	3543	2809	1430
85	1312	0	0

FLAT-BLADE LOUVER (PL)

SLLED-B3-SL-80/20-800-80-35-PL-4-4
80% up / 20% down at 800 lm/ft

PHOTOMETRIC CURVE

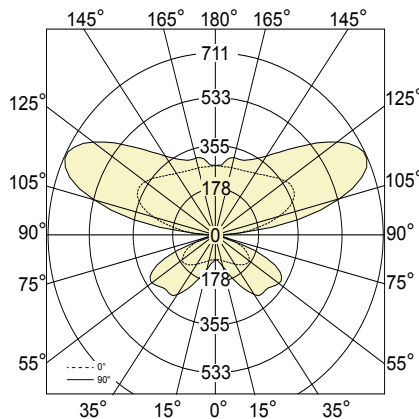

Lumen/ft up: 567 lm/ft
Lumen/ft down: 222 lm/ft
Total lumens: 3156 lm (for 4ft)
Input Watts: 33 W
Efficacy: 97 lm/W

CRI:80 shown (for CRI:90 use 0.8 multiplier on watts and efficacy)
IES FILE: SLLED-B3-SL-80-20-800-80-35-PL-4-4-W-120-D-1.IES

TESTED ACCORDING TO IES LM-79-2008

CANDELA DISTRIBUTION

Vertical Angle	Horizontal Angles				
	0	22.5	45	67.5	90
0	96	96	96	96	96
5	96	97	98	100	101
15	101	106	115	128	133
25	115	126	151	184	200
35	137	154	198	251	283
45	162	186	236	275	302
55	174	197	235	279	328
65	140	150	171	218	278
75	73	69	58	38	30
85	9	4	0	0	0
90	0	0	0	0	0
95	90	87	98	106	101
105	273	293	371	489	541
115	370	408	505	647	711
125	367	404	484	591	637
135	328	357	404	465	488
145	296	326	342	371	381
155	280	313	315	324	326
165	274	285	310	315	314
175	271	273	275	278	277
180	273	273	273	273	273

ZONAL LUMENS

Zone	Lumens
0	
0-10	10
10-20	34
20-30	72
30-40	128
40-50	180
50-60	213
60-70	181
70-80	64
80-90	5
90	
90-100	118
100-110	404
110-120	513
120-130	443
130-140	318
140-150	218
150-160	146
160-170	85
170-180	27
180	

LUMINANCE DATA (cd/m²)

Vertical Angle	Horizontal Angles		
	0	45	90
45	2254	3283	4193
55	2979	4021	5624
65	3263	3970	6472
75	2783	2191	1125
85	1055	0	0

i All IES files are available for download at: www.axislighting.com



● PHOTOMETRIC DATA

FLAT-BLADE LOUVER (PL)

SLLED-B3-SL-80/20-1500-80-35-PL-4-4
80% up / 20% down at 1500 lm/ft

PHOTOMETRIC CURVE

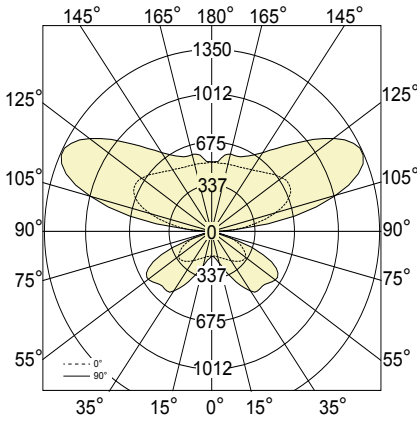

Lumen/ft up: 1227 lm/ft
Lumen/ft down: 307 lm/ft
Total lumens: 6000 lm (for 4ft)
Input Watts: 53.9 W (13.5W/ft)
Efficacy: 111 lm/W

CANDELA DISTRIBUTION

Vertical Angle	Horizontal Angles				
	0	22.5	45	67.5	90
0	182	182	182	182	182
5	182	184	185	190	191
15	193	202	219	243	252
25	219	239	287	350	379
35	259	292	376	477	538
45	308	354	449	523	573
55	330	375	446	531	624
65	267	285	325	413	529
75	139	130	110	73	56
85	18	7	0	0	0
90	0	0	0	0	0
95	170	166	187	202	193
105	519	557	704	929	1027
115	702	775	960	1230	1350
125	698	768	920	1123	1211
135	622	679	768	883	928
145	563	619	651	705	723
155	532	594	599	615	619
165	520	541	588	599	597
175	516	519	522	528	526
180	519	519	519	519	519

ZONAL LUMENS

Zone	Lumens
0	
0-10	18
10-20	64
20-30	137
30-40	242
40-50	341
50-60	405
60-70	344
70-80	122
80-90	9
90	
90-100	224
100-110	768
110-120	975
120-130	842
130-140	605
140-150	414
150-160	277
160-170	162
170-180	51
180	

LUMINANCE DATA (cd/m²)

Vertical Angle	Horizontal Angles		
	0	45	90
45	4282	6237	7966
55	5659	7638	10684
65	6200	7543	12296
75	5286	4162	2137
85	2004	0	0

CRI:80 shown (for CRI:90 use 0.8 multiplier on watts and efficacy)
 IES FILE: SLLED-B3-SL-80-20-1500-80-35-PL-4-4-W-120-D-1.IES

TESTED ACCORDING TO IES LM-79-2008

i All IES files are available for download at: www.axislighting.com



● PHOTOMETRIC DATA

SMOOTH LENS (SM)

SLLED-B3-SL-80/20-1000-80-35-SM-4-4
80% up / 20% down at 1000 lm/ft

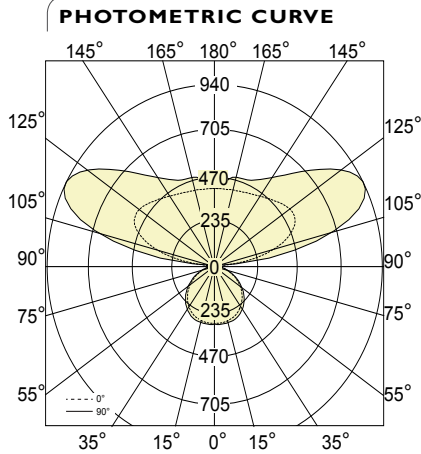

Lumen/ft up: 776 lm/ft
Lumen/ft down: 231 lm/ft
Total lumens: 4027 lm (for 4ft)
Input Watts: 42 W
Efficacy: 96 lm/W

CANDELA DISTRIBUTION

Vertical Angle	Horizontal Angles				
	0	22.5	45	67.5	90
0	301	301	301	301	301
5	298	300	299	303	304
15	293	296	298	302	303
25	280	283	288	294	295
35	255	258	264	269	271
45	217	221	226	231	233
55	169	172	175	180	181
65	113	114	116	119	120
75	53	54	55	57	56
85	2	2	2	1	1
90	0	0	0	0	0
95	109	106	119	134	124
105	353	380	476	628	697
115	496	544	668	849	935
125	512	562	662	799	862
135	474	522	576	654	686
145	439	491	506	542	555
155	416	465	478	485	487
165	404	418	461	473	472
175	399	400	401	407	406
180	400	400	400	400	400

ZONAL LUMENS

Zone	Lumens
0	29
0-10	84
10-20	133
20-30	165
30-40	174
40-50	157
50-60	115
60-70	59
70-80	7
80-90	145
90	521
90-100	678
100-110	605
110-120	453
120-130	321
130-140	218
140-150	127
150-160	39
160-170	180
170-180	180

LUMINANCE DATA (cd/m²)

Vertical Angle	Horizontal Angles		
	0	45	90
45	3003	3137	3236
55	2878	3001	3097
65	2610	2704	2782
75	1997	2093	2144
85	193	224	72

CRI:80 shown (for CRI:90 use 0.8 multiplier on watts and efficacy)
IES FILE: SLLED-B3-SL-80-20-1000-80-35-SM-4-4-W-120-D-1.IES

TESTED ACCORDING TO IES LM-79-2008

SMOOTH LENS (SM)

SLLED-B3-SL-80/20-800-80-35-SM-4-4
80% up / 20% down at 800 lm/ft

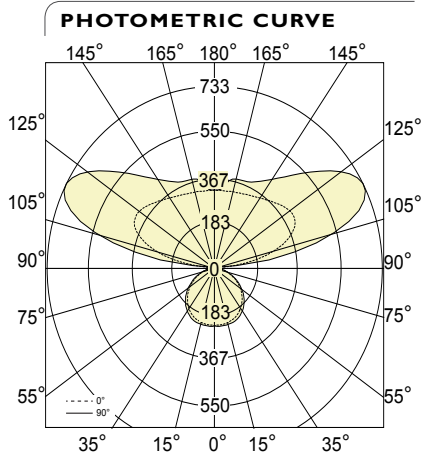

Lumen/ft up: 605 lm/ft
Lumen/ft down: 180 lm/ft
Total lumens: 3141 lm (for 4ft)
Input Watts: 33 W
Efficacy: 96 lm/W

CANDELA DISTRIBUTION

Vertical Angle	Horizontal Angles				
	0	22.5	45	67.5	90
0	235	235	235	235	235
5	232	234	233	236	237
15	229	231	232	236	236
25	218	221	225	229	230
35	199	201	206	210	211
45	169	172	176	180	182
55	132	134	137	140	141
65	88	89	90	93	94
75	41	42	43	44	44
85	2	2	2	1	1
90	0	0	0	0	0
95	85	83	93	105	97
105	275	296	371	490	544
115	387	424	521	662	729
125	399	438	516	623	672
135	370	407	449	510	535
145	342	383	395	423	433
155	324	363	373	378	380
165	315	326	360	369	368
175	311	312	313	317	317
180	312	312	312	312	312

ZONAL LUMENS

Zone	Lumens
0	22
0-10	66
10-20	104
20-30	129
30-40	136
40-50	122
50-60	90
60-70	46
70-80	6
80-90	113
90	406
90-100	529
100-110	472
110-120	354
120-130	251
130-140	170
140-150	99
150-160	31
160-170	180
170-180	180

LUMINANCE DATA (cd/m²)

Vertical Angle	Horizontal Angles		
	0	45	90
45	2351	2449	2525
55	2257	2338	2418
65	2049	2103	2175
75	1569	1628	1658
85	176	176	88

CRI:80 shown (for CRI:90 use 0.8 multiplier on watts and efficacy)
IES FILE: SLLED-B3-SL-80-20-800-80-35-SM-4-4-W-120-D-1.IES

TESTED ACCORDING TO IES LM-79-2008

i All IES files are available for download at: www.axislighting.com



● PHOTOMETRIC DATA

SMOOTH LENS (SM)

SLLED-B3-SL-80/20-1500-80-35-SM-4-4
80% up / 20% down at 1500 lm/ft

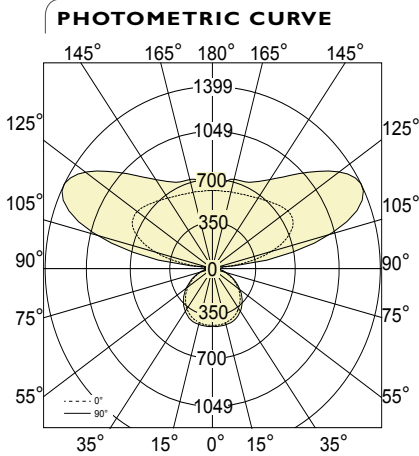

Lumen/ft up: 1227 lm/ft
Lumen/ft down: 307 lm/ft
Total lumens: 6000 lm (for 4ft)
Input Watts: 53 W
Efficacy: 113 lm/W

CANDELA DISTRIBUTION

Vertical Angle	Horizontal Angles				
	0	22.5	45	67.5	90
0	448	448	448	448	448
5	444	447	445	451	452
15	436	441	444	450	451
25	417	421	429	438	439
35	380	384	393	400	403
45	323	329	336	344	347
55	252	256	260	268	269
65	168	170	173	177	179
75	79	80	82	85	83
85	3	3	3	1	1
90	0	0	0	0	0
95	162	158	177	199	185
105	525	566	709	935	1037
115	738	810	994	1264	1392
125	762	837	985	1189	1283
135	706	777	857	973	1021
145	653	731	753	807	826
155	619	692	711	722	725
165	601	622	686	704	703
175	594	595	597	606	604
180	595	595	595	595	595

ZONAL LUMENS

Zone	Lumens
0	
0-10	43
10-20	126
20-30	198
30-40	245
40-50	259
50-60	233
60-70	171
70-80	87
80-90	11
90	
90-100	216
100-110	776
110-120	1010
120-130	901
130-140	675
140-150	478
150-160	325
160-170	189
170-180	58
180	

LUMINANCE DATA (cd/m²)

Vertical Angle	Horizontal Angles		
	0	45	90
45	4487	4673	4818
55	4308	4461	4614
65	3909	4013	4151
75	2994	3107	3163
85	336	336	168

CRI:80 shown (for CRI:90 use 0.8 multiplier on watts and efficacy)
IES FILE: SLLED-B3-SL-80-20-1500-80-35-SM-4-4-W-120-D-1.IES

TESTED ACCORDING TO IES LM-79-2008