

SIDE VIEW A

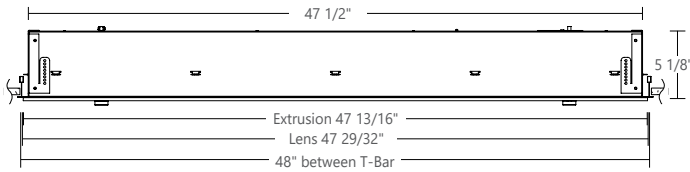

SIDE VIEW B

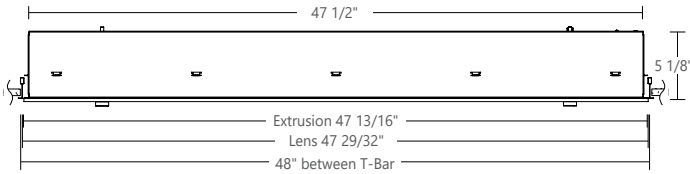

Project _____

Type _____

Notes _____

PERFORMANCE PER LINEAR FOOT AT 3500K

NOMINAL LUMEN OUTPUT	INPUT WATTS*	EFFICACY
4800 lm	39 W	123 lm/W
8000 lm	70 W	114 lm/W
10000 lm	89 W	112 lm/W
12000 lm	108 W	108 lm/W

* Based on a 4'x4' luminaire using two drivers
Please consult factory for custom lumen output and wattage.



Ordering Guide

SKSLED	44				GL	FL
PRODUCT ID	SIZE	TOTAL NOM. LUMENS	CRI	COLOR TEMP.	SHIELDING	SHIELDING POSITION
SKSLED Recessed LED	44 4'X4'	4800 4800 lm - Minimum 12000 12000 lm - Maximum	80 80 CRI 90 90 CRI	30 3000 K 35 3500 K 40 4000 K	GL GL optics	FL flush
Outputs between listed min and max are available. Consult factory for outputs outside of the listed range.						

VOLTAGE	DRIVER	CIRCUITS	MOUNTING/SUSPENSION	BATTERY (OPTIONAL)
120 120 V 277 277 V 347 347 V UNV universal	DP dimming (0-10V) 1% LT lutron (1) BI bi-level dimming O other (2)	1 1 circuit +E(#) emergency section (3) +NL(#) night light section (3) +GTD(#) generator transfer device (3)	TB9 t-bar 9/16" TB15 t-bar 15/16" ST screw slot t-bar TG9 tegular 9/16" TG15 tegular 15/16" DFK drywall with flange kit	B# battery pack
(1) Specify system (2) Please consult factory; see page 2		(3) Specify quantity	Please consult factory	

OTHER (OPTIONAL)	REMOTE CONTROLS (OPTIONAL)	CUSTOM (OPTIONAL)
F fuse (4) FW(#) flex whip (6' std) CP chicago plenum	DS# daylight sensor OS# occupancy sensor DOS# daylight & occupancy sensor ENR# enlightened remote (5) WC# wireless control dimming	C custom
(4) Requires 120V or 277V	(5) Please consult factory Specify quantity. Remote only. See integrated controls guide for more details.	Please specify

SPECIFY DRIVER NAME (if needed)

SPECIFY BATTERY NAME (if needed)

● SPECIFICATIONS

CONSTRUCTION

- Housing** Die formed cold rolled sheet steel (20 gauge).
- Optics** Acrylic crystal glass optics.
- Reflectors** High reflectance post painted steel.
- Drywall Flange Kit** Extruded aluminum (0.060" nominal).
- Luminaire support** Integrated Hold-Down clip

● ELECTRICAL

- Lutron driver*** LDE1 - EcoSystem H-Series (1%)
LDE5 - EcoSystem 5-Series (5%)
LTE - Hi-Lume® A-series 2Wires Forward Phase (1%)
*Consult factory
- Other drivers** DALI - Digital Addressable Lighting Interface
DMX - Digital Multiplex
LV - line voltage - Advance Mark 10
Xitanium SR - For wireless sensor
POE (Power over Ethernet) - Low Voltage Lighting System.
- Emergency** Integral emergency battery pack or emergency circuit optional.
- Input Voltage** 120V, 277V, 347V, UNV.
- Flex Whip** Shipped in a separate box for contractors to install

i Incorporating these components may have limitations or affect the length of the luminaire. Please contact factory for more details.

● WARRANTY

Axis lighting will warrant defective LEDs, boards, and drivers for 5 years from date of purchase. Warranty is valid if luminaire is installed and used according to specifications. If defective, Axis will send replacement boards or drivers at no cost along with detailed replacement instructions and instructions on how to return defective components to Axis.

● APPROVALS

- Certified to UL and CSA standards 
- Chicago Plenum Certified (CCEA)
- Meets NYC requirements
- Suitable for damp locations.
- IC Rated (Insulated ceiling)

● WEIGHT

Drywall with Kit 85 lbs / 38.5 kg

● STANDARD AND END MOUNT POWER FEED

Knockouts for BX cable connection are provided both on the top and on the ends of the luminaire. This allows for an end mount power feed solution if it is required.

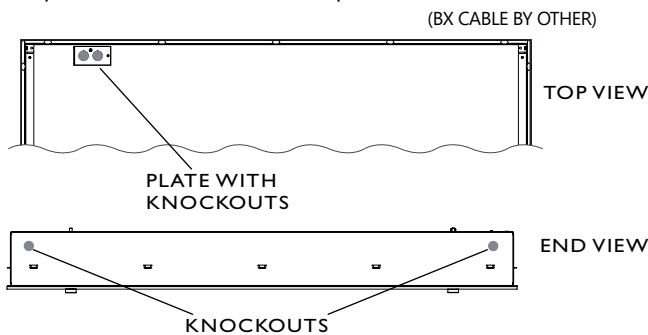

● CEILING SYSTEM

T-BAR STYLE MOUNTING

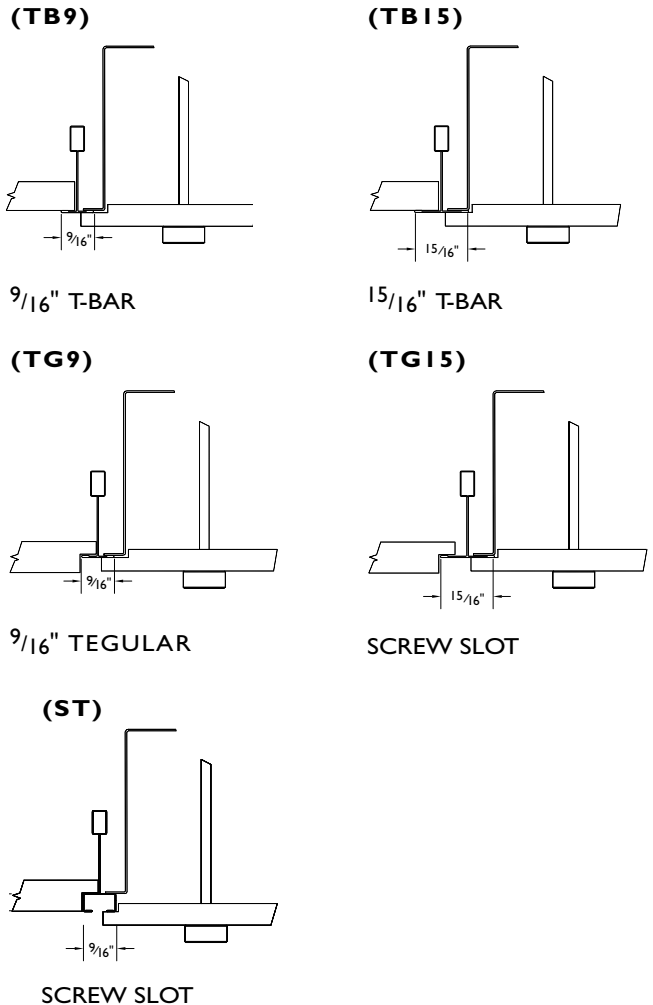

● DRYWALL WITH FLANGE KIT (DFK)

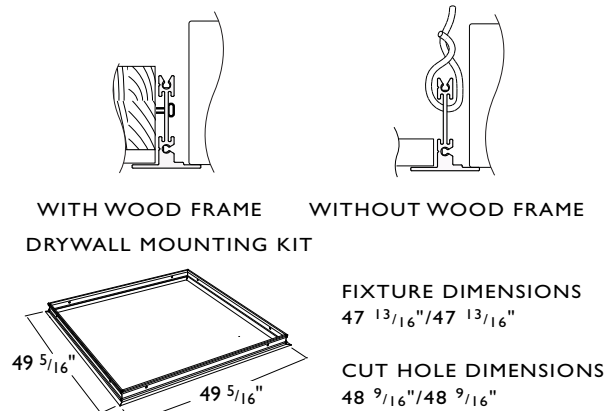

i Installation sheets for all mounting options are available at: www.axislighting.com

● PHOTOMETRIC DATA

PHOTOMETRIC CURVE

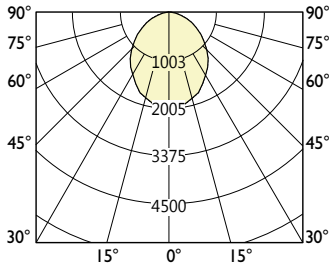

Luminaire Lumens: 4800 lm
Input Watts: 39 W
Efficacy: 120 lm/W
 IES FILE: SKSLED-44-B4-4800-80-35-GL.ies

TESTED ACCORDING TO IES LM-79-2008

CANDELA DISTRIBUTION

Vertical Angle	Horizontal Angles				
	0	22.5	45	67.5	90
0	2005	2005	2005	2005	2005
5	1989	1986	1984	1984	1984
15	1869	1868	1868	1869	1869
25	1641	1640	1641	1642	1641
35	1403	1403	1406	1406	1408
45	1141	1141	1142	1145	1147
55	807	808	811	815	817
65	525	523	527	530	531
75	243	243	245	246	248
85	47	47	48	48	48
90	8	8	9	9	8

ZONAL LUMENS

Zone	Lumens
0	
0-10	189
10-20	530
20-30	763
30-40	876
40-50	870
50-60	725
60-70	517
70-80	266
80-90	65
90	

LUMINANCE DATA (cd/m²)

Vertical Angle	Horizontal Angles		
	0	45	90
45	1087	1088	1093
55	948	953	960
65	837	841	846
75	633	637	646
85	365	372	372

PHOTOMETRIC CURVE

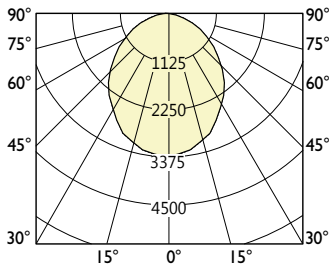

Luminaire Lumens: 8070 lm
Input Watts: 70 W
Efficacy: 114 lm/W
 IES FILE: SKSLED-44-B4-8000-80-35-GL.ies

TESTED ACCORDING TO IES LM-79-2008

CANDELA DISTRIBUTION

Vertical Angle	Horizontal Angles				
	0	22.5	45	67.5	90
0	3414	3414	3414	3414	3414
5	3358	3354	3350	3352	3352
15	3150	3150	3150	3151	3151
25	2790	2790	2795	2797	2795
35	2367	2369	2374	2374	2379
45	1874	1874	1876	1879	1886
55	1349	1354	1358	1371	1378
65	871	871	878	885	885
75	409	416	418	423	425
85	75	78	78	78	81
90	14	14	14	14	14

ZONAL LUMENS

Zone	Lumens
0	
0-10	319
10-20	891
20-30	1290
30-40	1481
40-50	1446
50-60	1214
60-70	868
70-80	452
80-90	109
90	

LUMINANCE DATA (cd/m²)

Vertical Angle	Horizontal Angles		
	0	45	90
45	1786	1788	1798
55	1584	1595	1618
65	1389	1400	1411
75	1064	1087	1106
85	581	606	625

PHOTOMETRIC CURVE

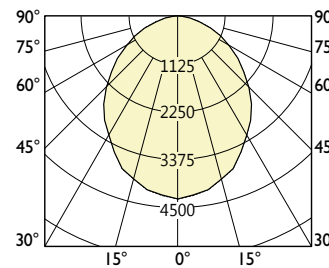

Luminaire Lumens: 10088 lm
Input Watts: 89 W
Efficacy: 113 lm/W
 IES FILE: SKSLED-44-B4-I0000-80-35-GL.ies

TESTED ACCORDING TO IES LM-79-2008

CANDELA DISTRIBUTION

Vertical Angle	Horizontal Angles				
	0	22.5	45	67.5	90
0	4267	4267	4267	4267	4267
5	4198	4192	4187	4190	4190
15	3937	3937	3937	3939	3939
25	3488	3488	3494	3496	3494
35	2959	2961	2968	2968	2974
45	2343	2343	2345	2349	2358
55	1686	1693	1697	1714	1722
65	1089	1089	1098	1106	1106
75	511	520	522	529	531
85	94	98	98	98	101
90	17	17	17	17	17

ZONAL LUMENS

Zone	Lumens
0	
0-10	398
10-20	1114
20-30	1612
30-40	1851
40-50	1808
50-60	1517
60-70	1085
70-80	565
80-90	136
90	0

LUMINANCE DATA (cd/m²)

Vertical Angle	Horizontal Angles		
	0	45	90
45	2233	2235	2247
55	1981	1994	2023
65	1736	1751	1763
75	1330	1359	1382
85	727	758	781

● PHOTOMETRIC DATA

PHOTOMETRIC CURVE

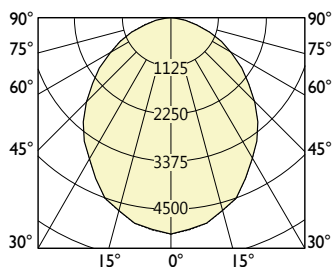

Luminaire Lumens: 12105 lm

Input Watts: 108.4W

Efficacy: 110 lm/W

IES FILE: SKSLED-44-B4-12000-80-35-GL.ies

TESTED ACCORDING TO IES LM-79-2008

CANDELA DISTRIBUTION

Vertical Angle	Horizontal Angles				
	0	22.5	45	67.5	90
0	5120	5120	5120	5120	5120
5	5038	5030	5024	5028	5028
15	4724	4724	4724	4727	4727
25	4186	4186	4193	4195	4193
35	3551	3553	3562	3562	3569
45	2812	2812	2814	2819	2830
55	2023	2032	2036	2057	2066
65	1307	1307	1318	1327	1327
75	613	624	626	635	637
85	113	118	118	118	121
90	20	20	20	20	20

ZONAL LUMENS

Zone	Lumens
0	
0-10	478
10-20	1337
20-30	1935
30-40	2221
40-50	2169
50-60	1821
60-70	1302
70-80	678
80-90	163
90	0

LUMINANCE DATA (cd/m²)

Vertical Angle	Horizontal Angles		
	0	45	90
45	2679	2681	2696
55	2377	2392	2427
65	2083	2101	2116
75	1596	1631	1659
85	872	909	937