



Project _____

Type _____

Notes _____

PERFORMANCE AT 4000K

NOMINAL LUMEN OUTPUT	INPUT WATTS*	EFFICACY
2500 lm	23.29 W	109 lm/W
3000 lm	28.49 W	105 lm/W
4000 lm	39.22 W	102 lm/W
4400 lm	43.64 W	101 lm/W

* Based on a 2'x2' luminaire using one driver
Please consult factory for custom lumen output and wattage.

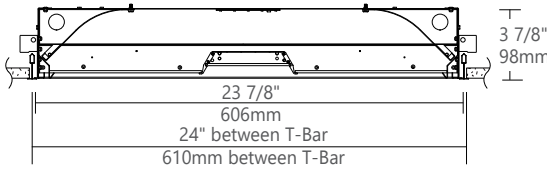
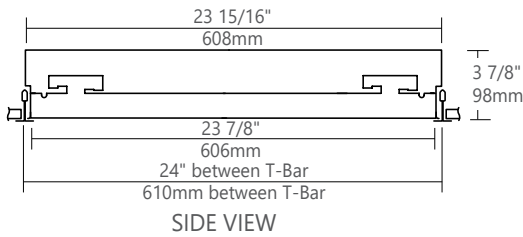

UL
CERTIFIED
SAFETY US/CA

DLC
LISTED

*Check the latest update on the DLC website for complete information. Not all versions may be DLC qualified. See page 2 for DLC Approved options

IC
cULus Listed
Type I.C.

CONTROL
SENSORS

LED BOARD & DRIVER
5 YEAR
LUMINAIRE
WARRANTY

Ordering Guide

POLED		SIZE	NOMINAL LUMENS	CRI	COLOR TEMP.	SHIELDING	FINISH
PRODUCT ID	Plano LED	22 2'X2'	2500 2500 lm - Minimum 4400 4400 lm - Maximum	80 80 CRI 90 90 CRI	27 2700 K 30 3000 K 35 3500 K 40 4000 K	VL VL optics	W white C custom
			Outputs between listed min and max are available. Consult factory for outputs outside of the listed range.				

VOLTAGE	DRIVER	CIRCUITS	MOUNTING	BATTERY (OPTIONAL)
120 120 V 277 277 V 347 347 V UNV universal	DP dimming (0-10V) 1% LT lutron (1) BI bi-level dimming O other (2)	1 1 circuit +E(#) emergency circuit (3) +NL(#) night light circuit (3) +GTD(#) generator transfer device (3)	TB9 t-bar 9/16" TB15 t-bar 15/16" ST screw slot t-bar TG9 tegular 9/16" TG15 tegular 15/16" DF drywall flange	B# battery Pack
(1) Specify system (2) Please consult factory		(3) Specify quantity	Please consult factory Not available with 347V	

OTHER (OPTIONAL)	IC CONTROLS (OPTIONAL)	CUSTOM (OPTIONAL)
F fuse (4) FW(#) flex whip (6' std) AR air return CP chicago plenum	DS# daylight sensor OS# occupancy sensor DOS# daylight & occupancy sensor EN# Enlighted integral (5) ENR# Enlighted remote (5) WC# wireless control dimming	C custom
(4) Requires 120V or 277V	(5) Please consult factory Specify quantity. Requires 1.5" blank. See integrated controls guide for more details.	Please specify

SPECIFY DRIVER NAME (if needed)

SPECIFY BATTERY NAME (if needed)

● SPECIFICATIONS

CONSTRUCTION

Housing	Die formed cold rolled sheet steel (20 gauge)
Central Lens Housing	Extruded aluminum (0.060" nominal)
Center Lens	PMMA Precision formed microconical structure 92 percent transmission, cuts off glare above 55°.
Side lens	0.08" PMMA satin blend
Reflectors	Die formed cold rolled sheet steel (22 gauge)
Interior Brackets	Die formed cold rolled sheet steel (20 gauge)
Drywall Flange Kit	Extruded aluminum (0.060" nominal)

● ELECTRICAL

Lutron driver*	LDE1 - EcoSystem H-Series (1%) LDE5 - EcoSystem 5-Series (5%) LTE - Hi-Lume® A-series 2Wires Forward Phase (1%) *Consult factory
Other drivers	DALI - Digital Addressable Lighting Interface DMX - Digital Multiplex LV - line voltage - Advance Mark 10 Xitanium SR - For wireless sensor POE (Power over Ethernet) - Low Voltage Lighting System.
Emergency	Integral emergency battery pack or emergency circuit optional.
Input Voltage	120V, 277V, 347V, UNV.
Flex Whip	Shipped in a separate box for contractors to install

i Incorporating these components may have limitations or affect the length of the luminaire. Please contact factory for more details.

● FINISH

Highly reflective, matte powder coat white paint for high efficiency. Matte texture to diffuse glare and lamp image on the surface within the optical chamber exterior. Custom finishes are also available.

● WARRANTY

Axis lighting will warrant defective LEDs, boards, and drivers for 5 years from date of purchase. Warranty is valid if luminaire is installed and used according to specifications. If defective, Axis will send replacement boards or drivers at no cost along with detailed replacement instructions and instructions on how to return defective components to Axis.

● APPROVALS

Certified to UL and CSA standards
Chicago Plenum Certified (CCEA)
Meets NYC requirements
Suitable for damp locations.
IC Rated (Insulated ceiling)



*Check the latest update on the DLC website for complete information. Not all versions may be DLC qualified.

● DLC Approved Options

SIZE	OUTPUT	CRI	CCT (K)	SHIELDING	FINISH	VOLTAGE	DRIVER	CIRCUITS
2'X2'	2500 lm	80	3000 K	VL	white	universal	DP	1
	3000 lm		3500 K					
	4000 lm		4000 K					
	4400 lm							

● WEIGHT

Standard	19 lbs / 8.6 kg
Drywall with Kit	21 lbs / 9.6 kg

● CEILING SYSTEM

T-BAR STYLE MOUNTING

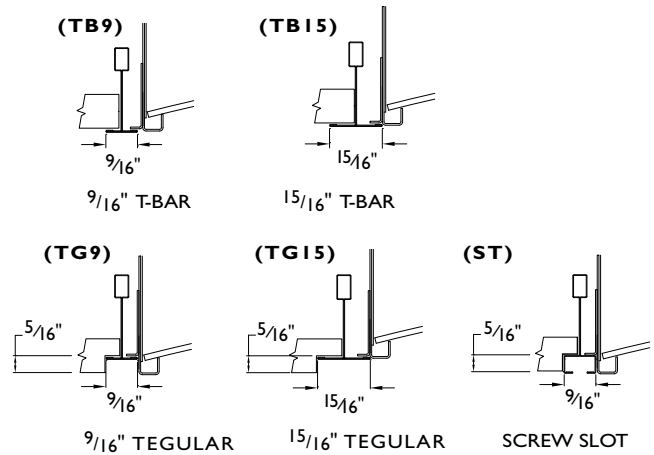

DRYWALL WITH FLANGE KIT (DF)

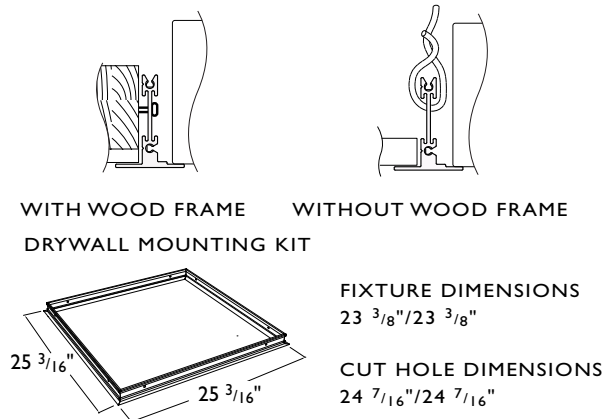

i Installation sheets for all mounting options are available at: www.axislighting.com

● STANDARD AND END MOUNT POWER FEED

Knockouts for BX cable connection are provided both on the top and on the ends of the luminaire. This allows for an end mount power feed solution if it is required. (BX CABLE BY OTHER)

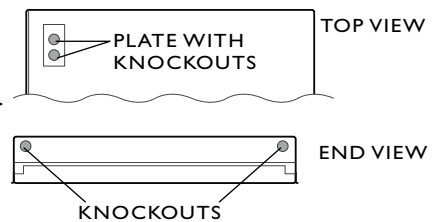

● AIR RETURN

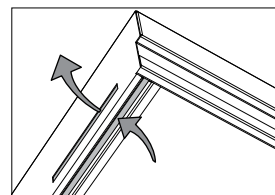

The air return (AR) option consists of discrete slots along the sides of the luminaire. These slots allow air to exhaust into the plenum and eliminate the need for unsightly air return grilles, and create a clean and well organized ceiling.

● **PHOTOMETRIC DATA**

LED

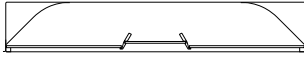

PHOTOMETRIC CURVE

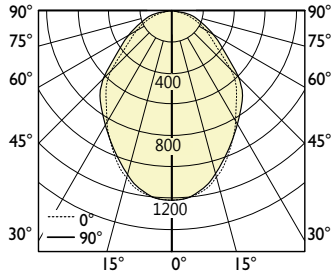

Luminaire Lumens: 2500 lm
Input Watts: 23.29 W
Efficacy: 109 lm/W
 IES FILE: POLED-22-2500-80-40-VL.ies

TESTED ACCORDING TO IES LM-79-2008

CANDELA DISTRIBUTION

Vertical Angle	Horizontal Angles					Zonal Lumens
	0	22.5	45	67.5	90	
0	1209	1209	1209	1209	1209	
10	1164	1163	1162	1161	1160	55.31
20	1015	1011	1014	1017	1016	95.11
30	820	832	853	869	875	116.56
40	650	671	708	727	733	123.24
50	400	425	445	470	487	93.63
60	249	273	293	313	323	69.14
70	152	167	182	197	212	46.88
80	69	76	86	87	86	22.04
90	0	0	0	0	0	

LUMINANCE DATA (cd/m²)

Vertical Angle	Horizontal Angles		
	0	45	90
45	2250	2464	2570
55	1594	1885	2046
65	1410	1642	1875
75	1312	1554	1819
85	957	923	786

COEFFICIENTS OF UTILIZATION (%)

Ceiling	80				70				50			
	70	50	30	10	70	50	30	10	50	30	10	
Wall	70	50	30	10	70	50	30	10	50	30	10	
0	119	119	119	119	117	117	117	117	111	111	111	
1	110	106	102	97	107	103	100	95	99	96	92	
2	101	93	87	79	98	91	86	79	88	83	77	
3	93	83	75	67	90	81	74	66	78	72	65	
4	86	74	66	57	83	73	65	57	71	64	56	
5	79	67	59	50	77	66	58	50	64	57	49	
6	73	61	52	44	72	60	52	44	58	51	44	
7	68	56	47	39	67	55	47	39	53	46	39	
8	64	51	43	35	62	50	43	35	49	42	35	
9	60	47	39	32	59	47	39	32	45	39	32	
10	56	44	36	29	55	43	36	29	42	35	29	

Based on floor reflectance of 20

LED

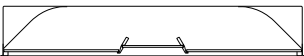

PHOTOMETRIC CURVE

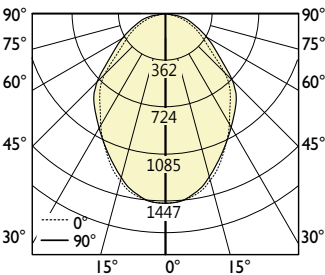

Luminaire Lumens: 3000 lm
Input Watts: 28.49 W
Efficacy: 105 lm/W
 IES FILE: POLED-22-3000-80-40-VL.ies

TESTED ACCORDING TO IES LM-79-2008

CANDELA DISTRIBUTION

Vertical Angle	Horizontal Angles					Zonal Lumens
	0	22.5	45	67.5	90	
0	1447	1447	1447	1447	1447	
10	1393	1392	1391	1390	1389	66
20	1215	1210	1214	1217	1216	114
30	982	996	1021	1040	1047	140
40	778	803	848	870	877	148
50	479	509	533	563	583	112
60	298	327	351	375	387	83
70	182	200	218	236	254	56
80	83	91	103	104	103	26
90	0	0	0	0	0	

LUMINANCE DATA (cd/m²)

Vertical Angle	Horizontal Angles		
	0	45	90
45	2693	2950	3076
55	1909	2257	2450
65	1688	1966	2245
75	1571	1860	2177
85	1146	1105	941

COEFFICIENTS OF UTILIZATION (%)

Ceiling	80				70				50			
	70	50	30	10	70	50	30	10	50	30	10	
Wall	70	50	30	10	70	50	30	10	50	30	10	
0	119	119	119	119	117	117	117	117	111	111	111	
1	110	106	102	97	107	103	100	95	99	96	92	
2	101	93	87	79	98	91	86	79	88	83	77	
3	93	83	75	67	90	81	74	66	78	72	65	
4	86	74	66	57	83	73	65	57	71	64	56	
5	79	67	59	50	77	66	58	50	64	57	49	
6	73	61	52	44	72	60	52	44	58	51	44	
7	68	56	47	39	67	55	47	39	53	46	39	
8	64	51	43	35	62	50	43	35	49	42	35	
9	60	47	39	32	59	47	39	32	45	39	32	
10	56	44	36	29	55	43	36	29	42	35	29	

Based on floor reflectance of 20

i All IES files are available for download at: www.axislighting.com

PHOTOMETRIC DATA

LED

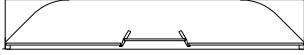

PHOTOMETRIC CURVE

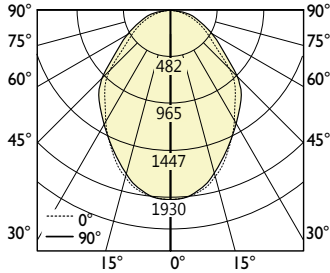

Luminaire Lumens: 4000 lm
Input Watts: 39.22 W
Efficacy: 102 lm/W
 IES FILE: POLED-22-4000-80-40-VL.ies

TESTED ACCORDING TO IES LM-79-2008

CANDELA DISTRIBUTION

Vertical Angle	Horizontal Angles					Zonal Lumens
	0	22.5	45	67.5	90	
0	1930	1930	1930	1930	1930	
10	1858	1856	1855	1853	1852	88
20	1620	1614	1619	1623	1622	152
30	1309	1328	1362	1387	1397	186
40	1038	1071	1130	1160	1170	197
50	638	678	710	750	777	149
60	397	436	468	500	516	110
70	243	267	291	314	338	75
80	110	121	137	139	137	35
90	0	0	0	0	0	

COEFFICIENTS OF UTILIZATION (%)

Ceiling	80				70				50			
	70	50	30	10	70	50	30	10	50	30	10	
Wall	70	50	30	10	70	50	30	10	50	30	10	
0	119	119	119	119	117	117	117	117	111	111	111	
1	110	106	102	97	107	103	100	95	99	96	92	
2	101	93	87	79	98	91	86	79	88	83	77	
3	93	83	75	67	90	81	74	66	78	72	65	
4	86	74	66	57	83	73	65	57	71	64	56	
5	79	67	59	50	77	66	58	50	64	57	49	
6	73	61	52	44	72	60	52	44	58	51	44	
7	68	56	47	39	67	55	47	39	53	46	39	
8	64	51	43	35	62	50	43	35	49	42	35	
9	60	47	39	32	59	47	39	32	45	39	32	
10	56	44	36	29	55	43	36	29	42	35	29	

Based on floor reflectance of 20

LUMINANCE DATA (cd/m²)

Vertical Angle	Horizontal Angles		
	0	45	90
45	3591	3934	4102
55	2545	3009	3266
65	2250	2621	2993
75	2094	2480	2903
85	1528	1473	1255

LED

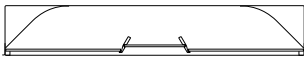

PHOTOMETRIC CURVE

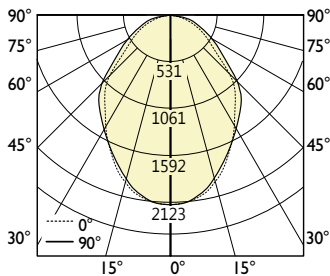

Luminaire Lumens: 4400 lm
Input Watts: 43.64 W
Efficacy: 101 lm/W
 IES FILE: POLED-22-4400-80-40-VL.ies

TESTED ACCORDING TO IES LM-79-2008

CANDELA DISTRIBUTION

Vertical Angle	Horizontal Angles					Zonal Lumens
	0	22.5	45	67.5	90	
0	2123	2123	2123	2123	2123	
10	2044	2042	2040	2038	2037	97
20	1782	1775	1780	1786	1784	167
30	1440	1461	1498	1526	1536	205
40	1141	1178	1243	1276	1287	216
50	702	746	781	825	855	164
60	437	479	514	550	567	121
70	267	293	320	346	372	82
80	121	133	151	153	151	39
90	0	0	0	0	0	

COEFFICIENTS OF UTILIZATION (%)

Ceiling	80				70				50			
	70	50	30	10	70	50	30	10	50	30	10	
Wall	70	50	30	10	70	50	30	10	50	30	10	
0	119	119	119	119	117	117	117	117	111	111	111	
1	110	106	102	97	107	103	100	95	99	96	92	
2	101	93	87	79	98	91	86	79	88	83	77	
3	93	83	75	67	90	81	74	66	78	72	65	
4	86	74	66	57	83	73	65	57	71	64	56	
5	79	67	59	50	77	66	58	50	64	57	49	
6	73	61	52	44	72	60	52	44	58	51	44	
7	68	56	47	39	67	55	47	39	53	46	39	
8	64	51	43	35	62	50	43	35	49	42	35	
9	60	47	39	32	59	47	39	32	45	39	32	
10	56	44	36	29	55	43	36	29	42	35	29	

Based on floor reflectance of 20

LUMINANCE DATA (cd/m²)

Vertical Angle	Horizontal Angles		
	0	45	90
45	3950	4357	4512
55	2799	3310	3593
65	2475	2884	3292
75	2304	2728	3193
85	1680	1620	1380

i All IES files are available for download at: www.axislighting.com