



Project _____

Type _____

Notes _____

PERFORMANCE AT 4000K

NOMINAL LUMEN OUTPUT	INPUT WATTS*	EFFICACY
900 lm	11.45 W	79 lm/W
1000 lm	12.88 W	78 lm/W
1200 lm	15.77 W	76 lm/W
1600 lm	21.73 W	74 lm/W

* Based on a 1'x1' luminaire using one driver
Please consult factory for custom lumen output and wattage.

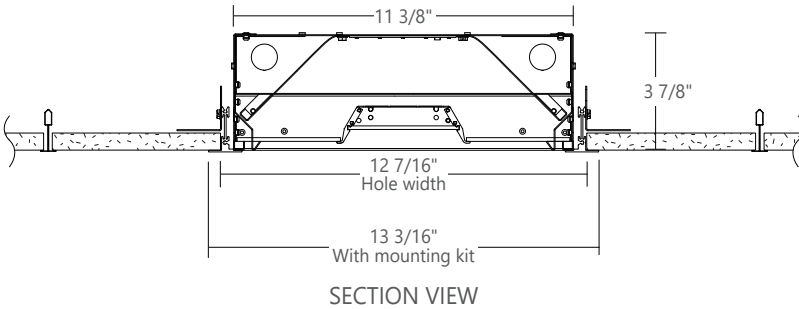

Ordering Guide

POLED		SIZE	NOMINAL LUMENS	CRI	COLOR TEMP.	SHIELDING	FINISH
POLED	Plano LED	11 1'X1'	900 900 lm - Minimum 1600 1600 lm - Maximum	80 80 CRI 90 90 CRI	27 2700 K 30 3000 K 35 3500 K 40 4000 K	VL VL optics	W white C custom
			Outputs between listed min and max are available. Consult factory for outputs outside of the listed range.				

VOLTAGE	DRIVER	CIRCUITS	MOUNTING	BATTERY (OPTIONAL)
120 120 V 277 277 V 347 347 V UNV universal	DP dimming (0-10V) 1% LT Lutron ⁽¹⁾ BI bi-level dimming O other ⁽²⁾	1 1 circuit +E(#) emergency circuit ⁽³⁾ +NL(#) night light circuit ⁽³⁾ +GTD(#) generator transfer device ⁽³⁾	DF drywall flange	B# battery pack
(1) Specify system (2) Please consult factory		(3) Specify quantity	Not available with 347V Please consult factory	

OTHER (OPTIONAL)	IC CONTROLS (OPTIONAL)	CUSTOM (OPTIONAL)
F fuse ⁽⁴⁾ AR air return FW(#) flex whip (6' std) CP chicago plenum	DS# daylight sensor OS# occupancy sensor DOS# daylight & occupancy sensor EN# Enlighted integral ⁽⁵⁾ ENR# Enlighted remote ⁽⁵⁾ WC# wireless control dimming	C custom
(4) Requires 120V or 277V	(5) Please consult factory Specify quantity. Requires 1.5" blank. See integrated controls guide for more details.	Please specify

SPECIFY DRIVER NAME (if needed)

SPECIFY BATTERY NAME (if needed)

● **SPECIFICATIONS**

CONSTRUCTION

Housing	Die formed cold rolled sheet steel (20 gauge)
Central Lens Housing	Extruded aluminum (0.060" nominal)
Center Lens	PMMA Precision formed microconical structure 92 percent transmission, cuts off glare above 55°.
Side lens	0.08" PMMA satin blend
Reflectors	Die formed cold rolled sheet steel (22 gauge)
Interior Brackets	Die formed cold rolled sheet steel (20 gauge)
Drywall Flange Kit	Extruded aluminum (0.060" nominal)

● **ELECTRICAL**

Lutron driver*	LDE1 - EcoSystem H-Series (1%) LDE5 - EcoSystem 5-Series (5%) LTE - Hi-Lume® A-series 2Wires Forward Phase (1%) *Consult factory
Other drivers	DALI - Digital Addressable Lighting Interface DMX - Digital Multiplex LV - line voltage - Advance Mark 10 Xitanium SR - For wireless sensor POE (Power over Ethernet) - Low Voltage Lighting System.
Emergency	Integral emergency battery pack or emergency circuit optional.
Input Voltage	120V, 277V, 347V, UNV.
Flex Whip	Shipped in a separate box for contractors to install

i Incorporating these components may have limitations or affect the length of the luminaire. Please contact factory for more details.

● **FINISH**

Highly reflective, matte powder coat white paint for high efficiency. Matte texture to diffuse glare and lamp image on the surface within the optical chamber exterior. Custom finishes are also available.

● **WARRANTY**

Axis lighting will warrant defective LEDs, boards, and drivers for 5 years from date of purchase. Warranty is valid if luminaire is installed and used according to specifications. If defective, Axis will send replacement boards or drivers at no cost along with detailed replacement instructions and instructions on how to return defective components to Axis.

● **APPROVALS**

Certified to UL and CSA standards 
Chicago Plenum Certified (CCEA)
Meets NYC requirements
Suitable for damp locations.
IC Rated (Insulated ceiling)

● **WEIGHT**

Standard	8 lbs / 3.6 kg
Drywall with Kit	9 lbs / 4.1 kg

● **CEILING SYSTEM**

T-BAR STYLE MOUNTING

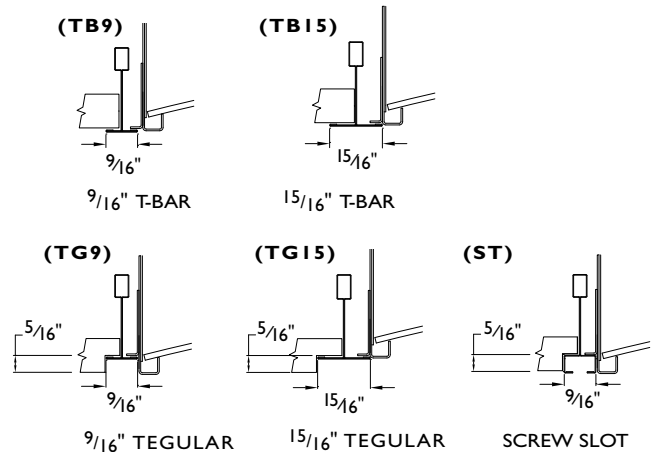

DRYWALL WITH FLANGE KIT (DF)

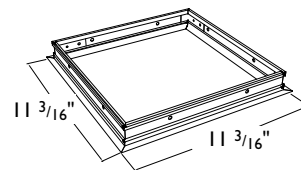
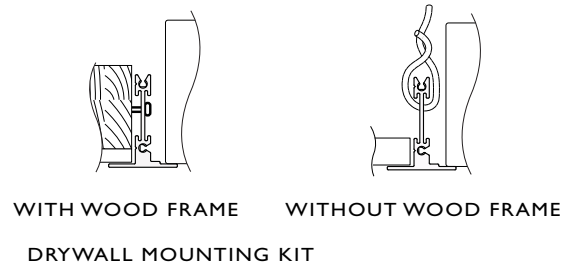

FIXTURE DIMENSIONS
11 3/8" / 11 3/8"

CUT HOLE DIMENSIONS
12 7/16" / 12 7/16"

i Installation sheets for all mounting options are available at: www.axislighting.com

● **STANDARD AND END MOUNT POWER FEED**

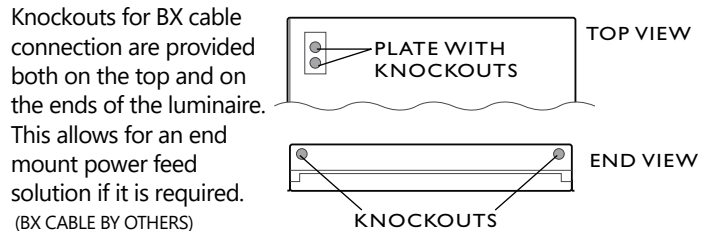

● **AIR RETURN**

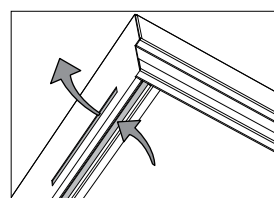

The air return (AR) option consists of discreet slots along the sides of the luminaire. These slots allow air to exhaust into the plenum and eliminate the need for unsightly air return grilles, and create a clean and well organized ceiling.

● **PHOTOMETRIC DATA**

LED

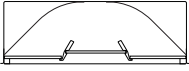

PHOTOMETRIC CURVE

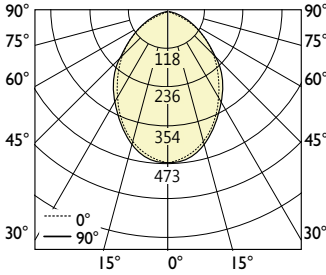

Luminaire Lumens: 900 lm
Input Watts: 11.45 W
Efficacy: 79 lm/W
 IES FILE: POLED-I1-900-80-40-VL.ies
 TESTED ACCORDING TO IES LM-79-2008

CANDELA DISTRIBUTION

Vertical Angle	Horizontal Angles					Zonal Lumens
	0	22.5	45	67.5	90	
0	473	473	473	473	473	
10	455	455	454	453	455	22
20	391	391	392	393	393	37
30	313	316	321	326	329	44
40	245	250	258	261	262	45
50	149	156	158	161	166	33
60	93	98	98	98	99	23
70	54	57	54	50	50	14
80	22	21	19	20	20	5
90	0	0	0	0	0	

LUMINANCE DATA (cd/m²)

Vertical Angle	Horizontal Angles		
	0	45	90
45	2277	2389	2433
55	1624	1775	1789
65	1382	1419	1419
75	1189	1067	1037
85	634	634	634

COEFFICIENTS OF UTILIZATION (%)

Ceiling	80				70				50			
	70	50	30	10	70	50	30	10	50	30	10	
Wall	70	50	30	10	70	50	30	10	50	30	10	
0	119	119	119	119	117	117	117	117	111	111	111	
1	111	107	103	98	108	104	101	96	100	97	94	
2	102	95	89	81	99	93	87	81	89	85	79	
3	94	85	77	69	92	83	76	69	80	74	68	
4	87	76	68	60	85	75	67	59	72	66	59	
5	81	69	61	52	79	68	60	52	66	59	52	
6	75	63	54	46	73	62	54	46	60	53	46	
7	70	57	49	41	68	57	49	41	55	48	41	
8	65	53	45	37	64	52	45	37	51	44	37	
9	61	49	41	34	60	48	41	34	47	40	34	
10	58	45	38	31	56	45	38	31	44	37	31	

Based on floor reflectance of 20

LED

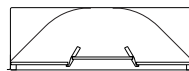

PHOTOMETRIC CURVE

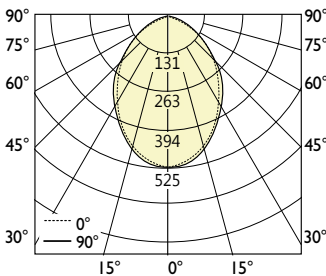

Luminaire Lumens: 1000 lm
Input Watts: 12.88 W
Efficacy: 78 lm/W
 IES FILE: POLED-I1-1000-80-40-VL.ies
 TESTED ACCORDING TO IES LM-79-2008

CANDELA DISTRIBUTION

Vertical Angle	Horizontal Angles					Zonal Lumens
	0	22.5	45	67.5	90	
0	525	525	525	525	525	
10	505	505	504	503	505	24
20	435	435	436	437	437	41
30	348	352	357	362	366	49
40	272	277	287	290	291	50
50	166	174	176	179	185	37
60	104	109	109	109	110	26
70	60	63	60	56	56	15
80	24	23	21	22	22	6
90	0	0	0	0	0	

LUMINANCE DATA (cd/m²)

Vertical Angle	Horizontal Angles		
	0	45	90
45	2530	2654	2704
55	1804	1972	1988
65	1536	1577	1577
75	1322	1186	1152
85	704	704	704

COEFFICIENTS OF UTILIZATION (%)

Ceiling	80				70				50			
	70	50	30	10	70	50	30	10	50	30	10	
Wall	70	50	30	10	70 <td>50</td> <td>30</td> <td>10</td> <td>50 <td>30</td> <td>10</td> </td>	50	30	10	50 <td>30</td> <td>10</td>	30	10	
0	119	119	119	119	117	117	117	117	111	111	111	
1	111	107	103	98	108	104	101	96	100	97	94	
2	102	95	89	81	99	93	87	81	89	85	79	
3	94	85	77	69	92	83	76	69	80	74	68	
4	87	76	68	60	85	75	67	59	72	66	59	
5	81	69	61	52	79	68	60	52	66	59	52	
6	75	63	54	46	73	62	54	46	60	53	46	
7	70	57	49	41	68	57	49	41	55	48	41	
8	65	53	45	37	64	52	45	37	51	44	37	
9	61	49	41	34	60	48	41	34	47	40	34	
10	58	45	38	31	56	45	38	31	44	37	31	

Based on floor reflectance of 20

i All IES files are available for download at: www.axislighting.com

● **PHOTOMETRIC DATA**

LED

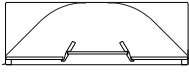

PHOTOMETRIC CURVE

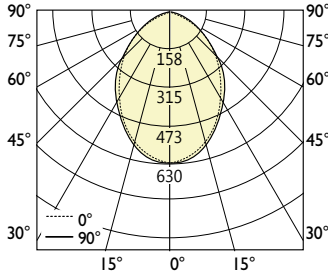

Luminaire Lumens: 1200 lm
Input Watts: 15.77 W
Efficacy: 76 lm/W
 IES FILE: POLED-I1-I200-80-40-VL.ies
 TESTED ACCORDING TO IES LM-79-2008

CANDELA DISTRIBUTION

Vertical Angle	Horizontal Angles					Zonal Lumens
	0	22.5	45	67.5	90	
0	630	630	630	630	630	
10	607	607	605	604	607	29
20	521	521	523	524	524	49
30	418	422	428	435	439	59
40	326	333	345	348	350	60
50	199	208	211	215	221	44
60	124	131	131	131	132	31
70	72	76	72	67	67	18
80	29	28	25	26	26	7
90	0	0	0	0	0	

LUMINANCE DATA (cd/m²)

Vertical Angle	Horizontal Angles		
	0	45	90
45	3036	3185	3245
55	2165	2367	2385
65	1843	1893	1893
75	1586	1423	1383
85	845	845	845

COEFFICIENTS OF UTILIZATION (%)

Ceiling	80				70				50			
	70	50	30	10	70	50	30	10	50	30	10	
Wall												
0	119	119	119	119	117	117	117	117	111	111	111	
1	111	107	103	98	108	104	101	96	100	97	94	
2	102	95	89	81	99	93	87	81	89	85	79	
3	94	85	77	69	92	83	76	69	80	74	68	
4	87	76	68	60	85	75	67	59	72	66	59	
5	81	69	61	52	79	68	60	52	66	59	52	
6	75	63	54	46	73	62	54	46	60	53	46	
7	70	57	49	41	68	57	49	41	55	48	41	
8	65	53	45	37	64	52	45	37	51	44	37	
9	61	49	41	34	60	48	41	34	47	40	34	
10	58	45	38	31	56	45	38	31	44	37	31	

Based on floor reflectance of 20

LED

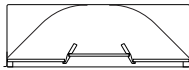

PHOTOMETRIC CURVE

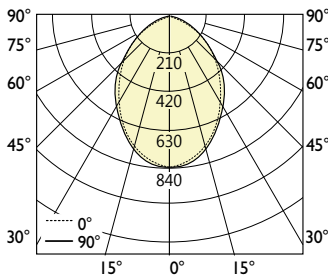

Luminaire Lumens: 1600 lm
Input Watts: 21.73 W
Efficacy: 74 lm/W
 IES FILE: POLED-I1-I1600-80-40-VL.ies
 TESTED ACCORDING TO IES LM-79-2008

CANDELA DISTRIBUTION

Vertical Angle	Horizontal Angles					Zonal Lumens
	0	22.5	45	67.5	90	
0	840	840	840	840	840	
10	809	809	807	805	809	38
20	695	695	697	699	699	65
30	557	562	571	580	585	78
40	435	444	459	465	466	80
50	266	278	281	286	295	59
60	166	175	175	175	176	41
70	96	101	96	89	89	24
80	38	37	33	35	35	10
90	0	0	0	0	0	

LUMINANCE DATA (cd/m²)

Vertical Angle	Horizontal Angles		
	0	45	90
45	4048	4247	4326
55	2887	3156	3180
65	2457	2523	2523
75	2114	1898	1843
85	1127	1127	1127

COEFFICIENTS OF UTILIZATION (%)

Ceiling	80				70				50			
	70	50	30	10	70	50	30	10	50	30	10	
Wall												
0	119	119	119	119	117	117	117	117	111	111	111	
1	111	107	103	98	108	104	101	96	100	97	94	
2	102	95	89	81	99	93	87	81	89	85	79	
3	94	85	77	69	92	83	76	69	80	74	68	
4	87	76	68	60	85	75	67	59	72	66	59	
5	81	69	61	52	79	68	60	52	66	59	52	
6	75	63	54	46	73	62	54	46	60	53	46	
7	70	57	49	41	68	57	49	41	55	48	41	
8	65	53	45	37	64	52	45	37	51	44	37	
9	61	49	41	34	60	48	41	34	47	40	34	
10	58	45	38	31	56	45	38	31	44	37	31	

Based on floor reflectance of 20

i All IES files are available for download at: www.axislighting.com