

Graze optics shown

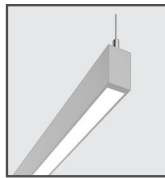

Flush shown

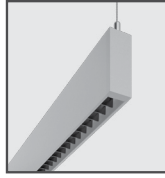

Louver shown

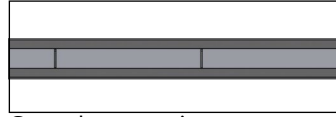

Graze bottom view

Project \_\_\_\_\_

Type \_\_\_\_\_

Notes \_\_\_\_\_

**REGRESSED 2"**

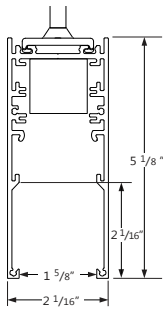

**REGRESSED 2" LOUVER**

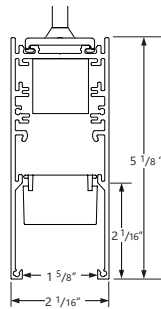

**FLUSH**

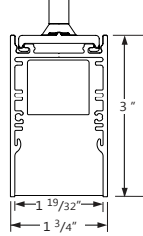

### Ordering Guide



cULus Listed  
Type I.C.

GPDLED		NOM. LUMENS/FT		CRI		COLOR TEMP.		SHIELDING	
<b>PRODUCT ID</b>	Graze Perfekt Pendant LED	<b>300</b>	300 lm/ft - Minimum	<b>80</b>	80 CRI	<b>27</b>	2700 K	<b>FL</b>	flush
		<b>1200</b>	1200 lm/ft - Maximum	<b>90</b>	90 CRI	<b>30</b>	3000 K	<b>RG2</b>	regressed 2"
						<b>35</b>	3500 K	<b>+LV</b>	louver (optional)*
						<b>40</b>	4000 K		
Outputs between listed min and max are available. Consult factory for outputs outside of the listed range.						<a href="#">Consult Axitune spec sheet for Axis color technology options</a>		Using linear Graze optic. *Louver is not available with flush option. See page 2 for more details.	

TOTAL LENGTH		FINISH		VOLTAGE		DRIVER		CIRCUITS		MOUNTING	
#	total length	<b>W</b>	white	<b>120</b>	120 V	<b>DP</b>	dimming (0-10V) 1%	<b>1</b>	1 circuit	<b>CA(#)</b>	drywall+cable length (36" std.)
		<b>BLK</b>	black	<b>277</b>	277 V	<b>LT</b>	Lutron <sup>(1)</sup>	<b>2</b>	2 circuits	<b>CT9(#)</b>	TB/TG 9/16+cable length (36" std.)
		<b>AP</b>	aluminum paint	<b>347</b>	347 V	<b>BI</b>	bi-level dimming	<b>+E(#)</b>	emergency circuit <sup>(3)</sup>	<b>CT15(#)</b>	TB/TG15/16+cable length (36" std.)
		<b>C</b>	custom	<b>UNV</b>	universal	<b>O</b>	other <sup>(2)</sup>	<b>+GTD(#)</b>	generator transfer device <sup>(3)</sup>	<b>CTS(#)</b>	ST+cable length (36" std.)
						(1) Specify system (2) Please consult factory; see page 2		(3) Specify quantity		<b>SA(#)</b>	drywall+stem length >48" (18" std.)
										<b>+SM</b>	seismic option
											Specify length

BATTERY (OPTIONAL)		CUSTOM (OPTIONAL)	
<b>B#</b>	battery pack 4' sections	<b>C</b>	custom
Not available with 347V Please consult factory		Please specify	

### ● LED SYSTEM

<b>CRI</b>	Minimum 80 or 90 color rendering index
<b>CCT</b>	Choice of 2700K, 3000K, 3500K and 4000K color temperature with a great color consistency (within 3.0-step MacAdam ellipse).
<b>LED life</b>	Minimum 50,000h with 85% of lumen maintenance in 25°C ambient temperature, in compliance with IES LM-80 testing measurements.
<b>Thermal Management</b>	Aluminum housing acting as the heat sink to maximize life.

### ● ELECTRICAL

<b>Lutron driver*</b>	LDE1 - EcoSystem H-Series (1%) LDE5 - EcoSystem 5-Series (5%) LTE - Hi-Lume® A-series 2Wires Forward Phase (1%) *Consult factory
<b>Other drivers</b>	DALI - Digital Addressable Lighting Interface DMX - Digital Multiplex LV - line voltage - Advance Mark 10 Xitanium SR - For wireless sensor
<b>Emergency</b>	Integral emergency battery pack or emergency circuit optional.
<b>Input Voltage</b>	120V, 277V, 347V, UNV.

**i** Incorporating these components may have limitations or affect the length of the luminaire. Please contact factory for more details.

### ● WARRANTY

Axis lighting will warrant defective LEDs, boards, and drivers for 5 years from date of purchase. Warranty is valid if luminaire is installed and used according to specifications. If defective, Axis will send replacement boards or drivers at no cost along with detailed replacement instructions and instructions on how to return defective components to Axis.

### ● FINISH

Powder coated and custom finishes are also available.

### ● WEIGHT

<b>Recessed 4 ft</b>	8 lbs / 3.6 kg
<b>Recessed 8 ft</b>	16 lbs / 7.3 kg
<b>Recessed 12 ft</b>	24 lbs / 10.9 kg

### ● MOUNTING OPTIONS

#### GT TILE CEILING - ON GRID

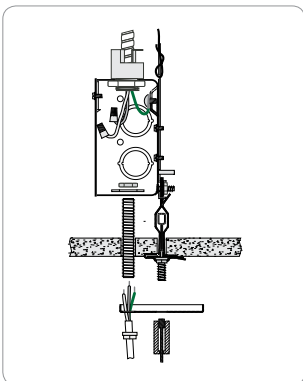

Power feed

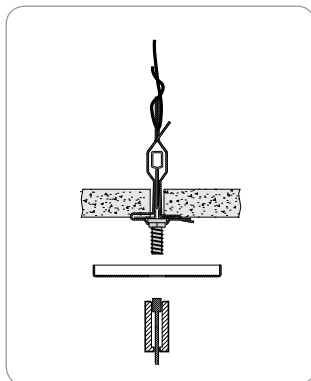

Non power feed

#### CA DRYWALL CEILING

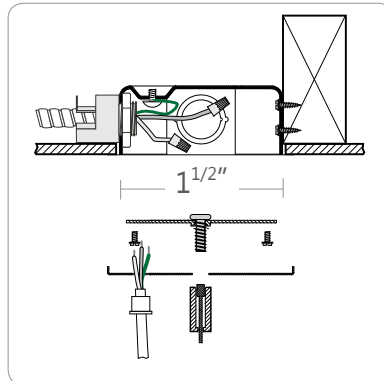

Power feed

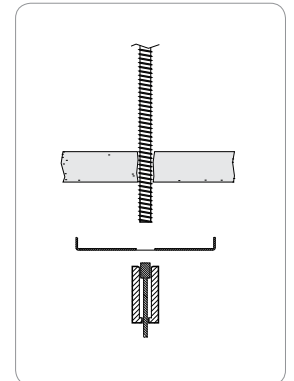

Non power feed

### ● SHIELDING (OPTIONAL)

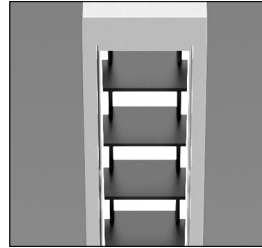

Graze Perfect optics with Louver shown.

### ● JOINERS

In order to allow very long runs of Graze Perfekt luminaires, Axis has developed an effective joining system. Special care has been taken to maximize the performance of the joiner for each Graze Perfekt option.

**NOTE:** Mount each system segment individually. Do not assemble system prior to mounting.

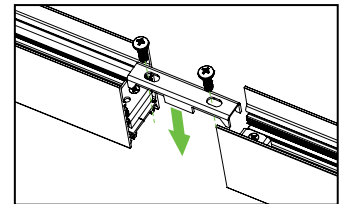

**i** Allow a minimum of 6" between end of long runs and vertical wall

### ● APPROVALS

Certified to UL and CSA standards   
Meets CCEC requirements (Chicago plenum)  
Suitable for damp locations.  
IC Rated (Insulated ceiling)

### ● CONSTRUCTION

<b>Housing</b>	Extruded aluminum (0.080" nominal) up to
<b>End Cap</b>	Die cast aluminum
<b>Interior Brackets</b>	Die formed sheet steel (20 gauge)
<b>Graze Optics</b>	Modular injection molded linear silicone 10°x100° optic
<b>Hanger</b>	Die cast aluminum

### ● PHOTOMETRIC DATA

300 lm/ft

#### PHOTOMETRIC CURVE

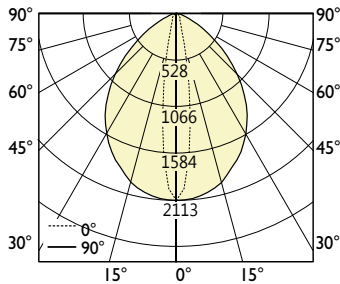

**Luminaire Lumens: 300 lm/ft**  
**Total Lumens: 1201 lm/ 4ft**  
**Input Watts: 2.5 W/ft**  
**Efficacy: 120 lm/W**

80 CRI shown. For 90 CRI, divide wattage by 0.8 and multiply efficacy by 0.8.  
 IES FILE: GPLD-300-80-35-FLIES

TESTED ACCORDING TO IES LM-79-2008

#### CANDELA DISTRIBUTION

Vertical Angle	Horizontal Angles				
	0	22.5	45	67.5	90
0	2113	2113	2113	2113	2113
5	2100	2020	1846	1689	1632
15	1976	1433	721	413	337
25	1727	770	210	128	114
35	1402	358	92	74	78
45	981	164	58	59	55
55	542	86	40	35	36
65	208	48	26	25	24
75	60	24	17	16	16
85	13	8	7	7	7
90	1	0	0	0	0

#### ZONAL LUMENS

Zone	Lumens
0	
0-10	161
10-20	262
20-30	235
30-40	199
40-50	154
50-60	101
60-70	54
70-80	26
80-90	8
90	0

#### LUMINANCE DATA (cd/m<sup>2</sup>)

Vertical Angle	Horizontal Angles		
	0	45	90
45	43876	845	637
55	29164	559	387
65	14600	353	249
75	6334	232	165
85	2900	100	77

400 lm/ft

#### PHOTOMETRIC CURVE

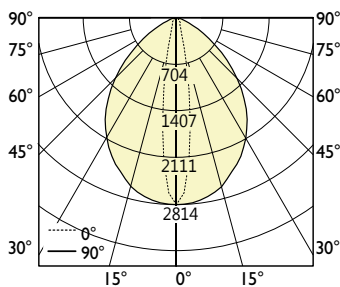

**Luminaire Lumens: 400 lm/ft**  
**Total Lumens: 1601 lm/ 4ft**  
**Input Watts: 3.3 W/ft**  
**Efficacy: 120 lm/W**

80 CRI shown. For 90 CRI, divide wattage by 0.8 and multiply efficacy by 0.8.  
 IES FILE: GPLD-400-80-35-FLIES

TESTED ACCORDING TO IES LM-79-2008

#### CANDELA DISTRIBUTION

Vertical Angle	Horizontal Angles				
	0	22.5	45	67.5	90
0	2814	2814	2814	2814	2814
5	2797	2692	2459	2250	2174
15	2633	1909	960	551	450
25	2300	1026	280	170	152
35	1868	476	122	98	103
45	1307	219	77	79	74
55	722	115	54	47	48
65	277	64	35	33	32
75	80	32	22	21	21
85	17	11	9	9	10
90	1	1	0	0	0

#### ZONAL LUMENS

Zone	Lumens
0	
0-10	214
10-20	350
20-30	314
30-40	265
40-50	206
50-60	135
60-70	72
70-80	34
80-90	11
90	0

#### LUMINANCE DATA (cd/m<sup>2</sup>)

Vertical Angle	Horizontal Angles		
	0	45	90
45	58452	1125	849
55	38853	745	515
65	19451	471	332
75	8439	309	220
85	3864	133	103

### ● PHOTOMETRIC DATA

#### 500 lm/ft

##### PHOTOMETRIC CURVE

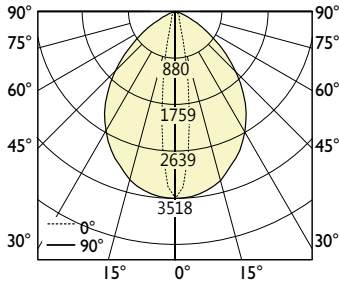

**Luminaire Lumens: 500 lm/ft**  
**Total Lumens: 2001 lm/ 4ft**  
**Input Watts: 4.15 W/ft**  
**Efficacy: 121 lm/W**

80 CRI shown. For 90 CRI, divide wattage by 0.8 and multiply efficacy by 0.8.  
 IES FILE: GPLD-500-80-35-FLIES

TESTED ACCORDING TO IES LM-79-2008

##### CANDELA DISTRIBUTION

Vertical Angle	Horizontal Angles				
	0	22.5	45	67.5	90
0	3518	3518	3518	3518	3518
5	3497	3365	3074	2812	2718
15	3291	2386	1200	688	562
25	2875	1282	350	213	189
35	2335	596	153	123	129
45	1633	274	96	98	92
55	903	144	67	59	60
65	347	80	43	41	40
75	100	39	28	27	27
85	21	13	12	12	12
90	2	1	0	0	0

##### ZONAL LUMENS

Zone	Lumens
0	
0-10	268
10-20	437
20-30	392
30-40	331
40-50	257
50-60	169
60-70	91
70-80	43
80-90	14
90	0

##### LUMINANCE DATA (cd/m²)

Vertical Angle	Horizontal Angles		
	0	45	90
45	73065	1406	1061
55	48567	931	644
65	24314	588	415
75	10548	386	274
85	4830	166	128

#### 750 lm/ft

##### PHOTOMETRIC CURVE

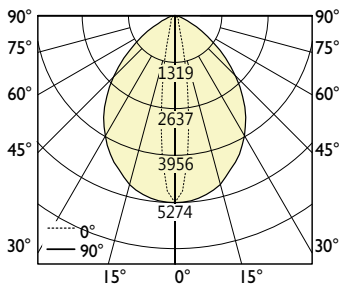

**Luminaire Lumens: 750 lm/ft**  
**Total Lumens: 3000 lm/ 4ft**  
**Input Watts: 6.25 W/ft**  
**Efficacy: 120 lm/W**

80 CRI shown. For 90 CRI, divide wattage by 0.8 and multiply efficacy by 0.8.  
 IES FILE: GPLD-750-80-35-FLIES

TESTED ACCORDING TO IES LM-79-2008

##### CANDELA DISTRIBUTION

Vertical Angle	Horizontal Angles				
	0	22.5	45	67.5	90
0	5274	5274	5274	5274	5274
5	5242	5044	4609	4216	4075
15	4934	3577	1799	1032	842
25	4311	1922	525	320	284
35	3500	893	229	184	194
45	2449	411	144	148	138
55	1354	216	100	89	90
65	520	119	65	61	60
75	150	59	42	40	40
85	32	20	17	18	18
90	2	1	1	0	0

##### ZONAL LUMENS

Zone	Lumens
0	
0-10	401
10-20	655
20-30	588
30-40	496
40-50	385
50-60	253
60-70	136
70-80	64
80-90	21
90	0

##### LUMINANCE DATA (cd/m²)

Vertical Angle	Horizontal Angles		
	0	45	90
45	109543	2108	1591
55	72814	1396	966
65	36453	882	622
75	15815	579	411
85	7241	248	193

### ● PHOTOMETRIC DATA

900 lm/ft

#### PHOTOMETRIC CURVE

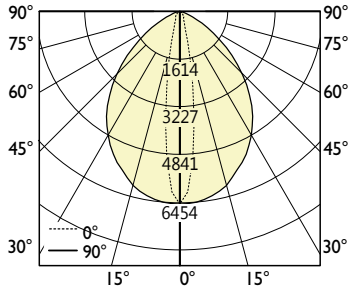

**Luminaire Lumens: 900 lm/ft**  
**Total Lumens: 3670 lm/ 4ft**  
**Input Watts: 7.6 W/ft**  
**Efficacy: 120 lm/W**

80 CRI shown. For 90 CRI, divide wattage by 0.8 and multiply efficacy by 0.8.  
 IES FILE: GPLD-900-80-35-FLIES

TESTED ACCORDING TO IES LM-79-2008

#### CANDELA DISTRIBUTION

Vertical Angle	Horizontal Angles				
	0	22.5	45	67.5	90
0	6454	6454	6454	6454	7033
5	5159	5639	6172	6415	5433
15	1263	2201	4377	6037	1123
25	391	643	2352	5275	379
35	226	280	1093	4283	258
45	181	177	502	2997	184
55	108	123	264	1656	120
65	75	79	146	636	80
75	49	51	72	184	53
85	22	21	24	39	24
90	1	1	1	3	1

#### ZONAL LUMENS

Zone	Lumens
0	
0-10	491
10-20	802
20-30	719
30-40	607
40-50	472
50-60	310
60-70	166
70-80	78
80-90	26
90	0

#### LUMINANCE DATA (cd/m<sup>2</sup>)

Vertical Angle	Horizontal Angles		
	0	45	90
45	52496	38168	637006
55	37851	27057	357545
65	29304	18310	143900
75	24011	12932	45115
85	14856	6035	10932

1000 lm/ft

#### PHOTOMETRIC CURVE

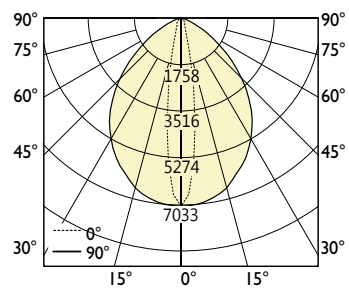

**Luminaire Lumens: 1000 lm/ft**  
**Total Lumens: 4000 lm/ 4ft**  
**Input Watts: 8.3 W/ft**  
**Efficacy: 120 lm/W**

80 CRI shown. For 90 CRI, divide wattage by 0.8 and multiply efficacy by 0.8.  
 IES FILE: GPLD-1000-80-35-FLIES

TESTED ACCORDING TO IES LM-79-2008

#### CANDELA DISTRIBUTION

Vertical Angle	Horizontal Angles				
	0	22.5	45	67.5	90
0	7033	7033	7033	7033	7033
5	6990	6726	6145	5622	5433
15	6579	4769	2399	1376	1123
25	5748	2563	701	426	379
35	4667	1190	306	246	258
45	3265	547	192	197	184
55	1805	287	134	118	120
65	693	159	86	82	80
75	200	79	56	53	53
85	43	27	23	24	24
90	3	2	1	1	1

#### ZONAL LUMENS

Zone	Lumens
0	
0-10	535
10-20	874
20-30	783
30-40	661
40-50	514
50-60	338
60-70	181
70-80	85
80-90	28
90	0

#### LUMINANCE DATA (cd/m<sup>2</sup>)

Vertical Angle	Horizontal Angles		
	0	45	90
45	146057	28111	2121
55	97085	1861	1288
65	48603	1176	830
75	21086	772	549
85	9655	331	257

### ● PHOTOMETRIC DATA

1200 lm/ft

#### PHOTOMETRIC CURVE

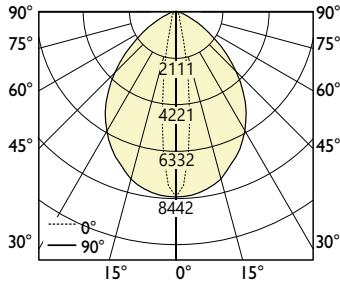

**Luminaire Lumens: 1200 lm/ft**  
**Total Lumens: 4801 lm/ 4ft**  
**Input Watts: 9.38 W/ft**  
**Efficacy: 128 lm/W**

80 CRI shown. For 90 CRI, divide wattage by 0.8 and multiply efficacy by 0.8.  
 IES FILE: GPLD-1200-80-35-FL.IES

TESTED ACCORDING TO IES LM-79-2008

#### CANDELA DISTRIBUTION

Vertical Angle	Horizontal Angles				
	0	22.5	45	67.5	90
0	8442	8442	8442	8442	8442
5	8390	8074	7376	6748	6522
15	7897	5725	2879	1652	1348
25	6900	3076	841	511	455
35	5603	1429	367	295	310
45	3920	657	231	236	221
55	2167	345	161	142	144
65	832	191	104	98	96
75	240	95	67	64	64
85	52	32	28	28	29
90	4	2	1	1	1

#### ZONAL LUMENS

Zone	Lumens
0	
0-10	642
10-20	1049
20-30	940
30-40	794
40-50	617
50-60	406
60-70	217
70-80	102
80-90	34
90	0

#### LUMINANCE DATA (cd/m<sup>2</sup>)

Vertical Angle	Horizontal Angles		
	0	45	90
45	128190	4501	3719
55	86307	3272	2464
65	44099	2277	1727
75	19937	1662	1248
85	10554	809	645

### ● PHOTOMETRIC DATA - GRAZE PERFEKT WITH LOUVER

200 lm/ft

#### PHOTOMETRIC CURVE

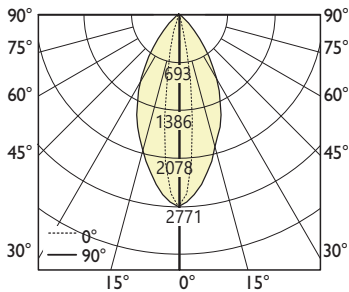

**Luminaire Lumens: 200 lm/ft**  
**Total Lumens: 765 lm/ 4ft**  
**Input Watts: 3.26 W/ft**  
**Efficacy: 59 lm/W**

80 CRI shown. For 90 CRI, divide wattage by 0.8 and multiply efficacy by 0.8.  
 IES FILE: GPLD-200-80-35-RG2-LV-4.IES

TESTED ACCORDING TO IES LM-79-2008

#### CANDELA DISTRIBUTION

Vertical Angle	Horizontal Angles				
	0	22.5	45	67.5	90
0	2771	2771	2771	2771	2771
5	2612	2577	2385	2177	2137
15	2006	1476	693	327	253
25	1406	591	90	36	30
35	760	148	18	9	10
45	195	28	8	9	10
55	22	6	7	8	9
65	4	4	6	6	6
75	1	3	4	4	4
85	0	1	1	1	1

#### ZONAL LUMENS

Zone	Lumens
0	
0-10	200
10-20	259
20-30	167
30-40	89
40-50	30
50-60	8
60-70	5
70-80	4
80-90	1
90	0

#### LUMINANCE DATA (cd/m<sup>2</sup>)

Vertical Angle	Horizontal Angles		
	0	45	90
45	13581	532	682
55	1857	617	741
65	463	703	741
75	192	749	790
85	163	745	694