

● **PROJECT INFORMATION**

Project:

Notes:

Type:

Approved by: Date:

● **DIMENSIONS**

SECTION VIEW

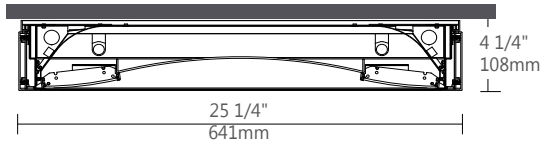

SIDE VIEW

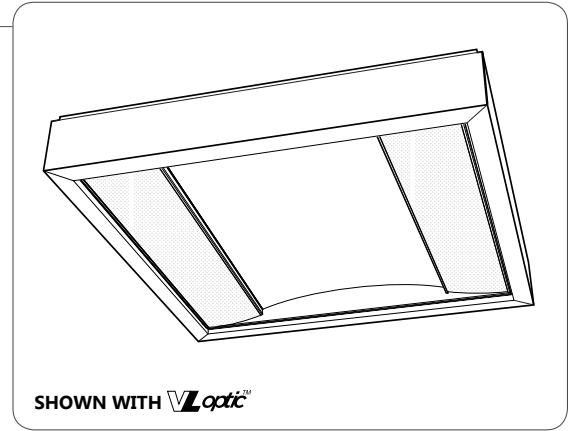
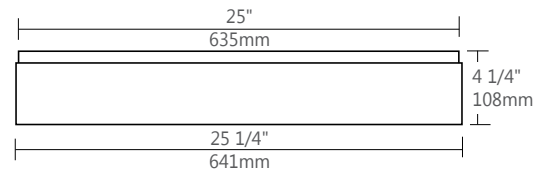

● **ORDERING CODE**

1	2	3	4	5	6	7	8	9	10	11	12	13	14
---	---	---	---	---	---	---	---	---	----	----	----	----	----

● **PRODUCT SPECIFICATIONS**

1 PRODUCT ID	2 SIZE	3 SIDE OPTIC	4 LAMP	5 LAMP CONFIGURATION	6 FINISH
DUO duo	22 2'X2'	VL vl optic	T5 T5 T5HO T5HO T8 T8 F25TT TT25W (2G11) F40TT TT40W (2G11) F50TT TT50W (2G11) F55TT TT55W (2G11)	2 2 lamps 4 4 lamps ⁽¹⁾	W white BLK black C custom
				<small>(1) Not available for F25/40/50/55TT</small>	

7 VOLTAGE	8 BALLAST	9 CIRCUITS	10 MOUNTING/SUSPENSION	11 BATTERY (OPTIONAL)
120 120V 277 277V 347 347V ⁽²⁾ UNV universal	D dimming E instant start ⁽³⁾ ERS program start BI bi-level dimming +M master +S satellite	1 1 regular 2 2 regular 2A/B 2 alternating +E(#) emergency section +NL(#) night light section +GTD(#) generator transfer device	SM surface mount	B# battery pack
<small>(2) Please consult factory</small>		<small>(3) Available with T8 lamp only</small>		

12 OTHER (OPTIONAL)	13 IC CONTROLS (OPTIONAL)	14 CUSTOM (OPTIONAL)
F fuse FW(#) flex whip (6' std)	DS# daylight sensor OS# occupancy sensor DS+OS# daylight+occupancy sensor DOS# daylight&occupancy sensor <small>See integrated controls guide for further details</small>	C custom <small>Please specify</small>

SPECIFY BALLAST NAME (if needed)

SPECIFY BATTERY NAME (if needed)

● **CEILING SYSTEM**

MOUNTING HOLES POSITION

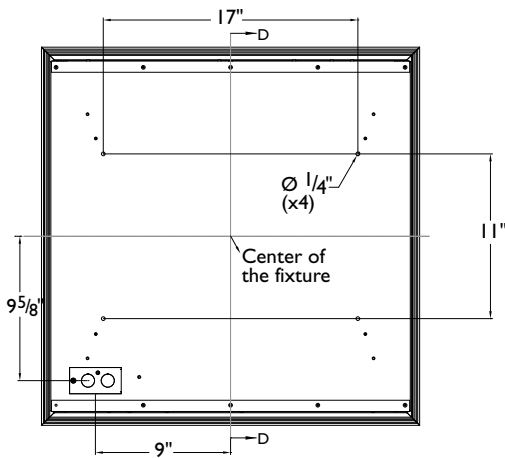

RECESSED OPTION

For more details see recessed specification sheets available at: www.axislighting.com

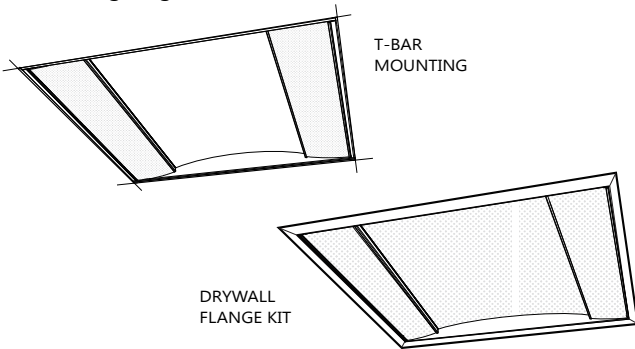

i Installation sheets for all mounting options are available at: www.axislighting.com

● **CONSTRUCTION**

Housing	Die formed cold rolled sheet steel (20 gauge)
Central Lens Housing Reflectors	Extruded aluminum (0.060" nominal) Die formed cold rolled sheet steel (22 gauge)
Interior Brackets	Die formed cold rolled sheet steel (20 gauge)
Surface Mount Kit	Extruded aluminum (0.070" nominal)

● **WEIGHT**

Surface Mount	26 lbs / 11.8 kg
----------------------	------------------

● **OPTICAL SYSTEM**

DUO optical system includes two side lenses and one center lens. Center lens has an extruded aluminum frame and can be opened to replace the lamps. Side lenses are 0.08" PMMA satin blend.

There are two available options for center lens:

VL^{opti}: PMMA Precision formed microconical structure (VL Optic) 92 percent transmissive that cuts off glare above 55 degrees.

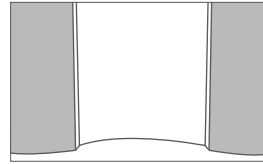

VL vl optic

● **FINISH**

Highly reflective, matte powder coat white paint for high efficiency yet has a matte texture to diffuse glare and lamp image on the surfaces within the optical chamber. Custom finishes are also available (exterior only).

● **ELECTRICAL**

Ballast	Electronic IS, Electronic Rapid Start, Dimming (0-10V, Line, EcoSystem, DALI), BI-level dimming With preinstalled ballast disconnect as per NEC & CEC
Emergency	Emergency battery pack or emergency circuit
Voltage	120V, 277V, 347V, UNV

● **APPROVALS**

Certified to UL and CUL standards  Suitable for damp locations.

● INTEGRATED CONTROL OPTIONS

DUO luminaires allow the use of integrated controls such as daylight sensors (DS), occupancy sensors (OS), individual daylight sensors and occupancy sensors (DS+OS), and combination daylight/occupancy sensors (DOS). These options can be seamlessly integrated into our luminaires. The control system could be used to optimize the lighting of the space by reducing energy consumption through daylight harvesting and occupancy, thereby improving the overall interior environment and allowing for LEED credits.

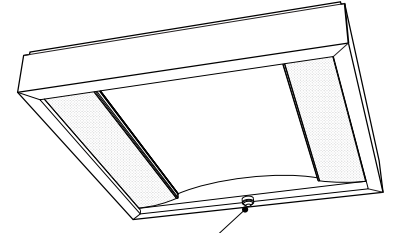

- Consult factory for other options.
- Refer to IC brochure for more information.

SENSORS	BRAND	Model	TYPE	CODE	COMPATIBLE DIMMING BALLAST
Daylight Sensor (DS)	Lutron	EC-DIR-WH	Daylight	LD	EcoSystem
	Wattstopper	FD-301	Daylight	WD	0-10V
	Philips	Luxsense	Daylight	PL	0-10V
Occupancy Sensor (OS)	Wattstopper	FS-205	PIR Occupancy	WP1	Programmed Rapid Start
		FS-355	PIR Occupancy	WP2	Programmed Rapid Start
		FS-155	PIR Occupancy	WP3	Programmed Rapid Start
		FS-505	Ultrasonic Occupancy	WU1	Programmed Rapid Start
		FS-505C	Ultrasonic Occupancy	WU2	Programmed Rapid Start
		FM-105	High Frequency Occupancy	WH	Programmed Rapid Start
Daylight & Occupancy Sensors (DOS)	Philips	Actilume	Daylight & PIR Occupancy	PA	DALI or 0-10V

● PHOTOMETRIC DATA

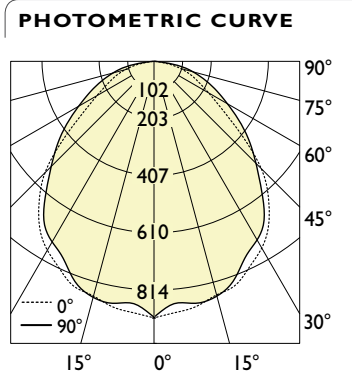
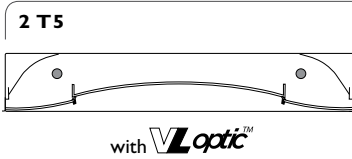

Test Lamp: 2x F14T5
 IES FILE: DUO22-VL-T5-2.ies

Efficiency: 83.1%

i All IES files are available for download at: www.axislighting.com

CANDELA DISTRIBUTION

Vertical Angle	Horizontal Angles					Zonal Lumens
	0	22.5	45	67.5	90	
0	886	886	886	886	886	
5	870	882	907	890	891	48
15	861	866	868	853	860	206
25	814	816	808	787	794	343
35	716	711	701	698	684	428
45	545	541	524	526	521	425
55	309	321	344	367	384	338
65	183	197	224	246	255	242
75	106	106	128	142	154	155
85	23	24	33	33	32	58
90	3	3	6	6	4	

LUMINANCE DATA (CD/M²)

Vertical Angle	Horizontal Angles		
	0	45	90
45	1798	1625	1715
55	1182	1213	1465
65	865	950	1196
75	678	701	979
85	246	273	337

COEFFICIENTS OF UTILIZATION (%)

Ceiling	80										70				50			
	70	50	30	10	70	50	30	10	50	30	10	50	30	10				
0	99	99	99	99	97	97	97	97	93	93	93							
1	91	87	84	81	89	86	83	80	82	80	77							
2	83	77	72	67	81	75	70	66	72	68	65							
3	76	68	62	56	74	67	61	56	64	59	55							
4	70	61	54	48	68	60	53	48	58	52	47							
5	65	55	47	42	63	54	47	42	52	46	41							
6	60	49	42	37	59	49	42	37	47	41	37							
7	56	45	38	33	54	44	38	33	43	37	33							
8	52	41	34	30	51	41	34	29	39	34	29							
9	49	38	31	27	48	37	31	27	36	31	26							
10	46	35	29	24	45	35	28	24	34	28	24							

Based on floor reflectance of 20

PHOTOMETRIC DATA

4 T5



with **VL_{opti}c™**

PHOTOMETRIC CURVE

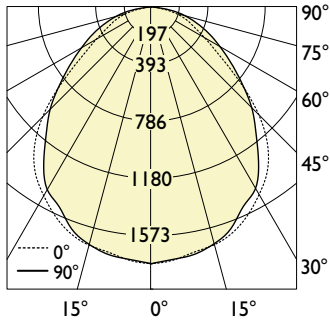

Test Lamp: 4xF14T5
 IES FILE: DUO22-VL-T5-4.ies

Efficiency: 79.5%

CANDELA DISTRIBUTION

Vertical Angle	Horizontal Angles					Zonal Lumens
	0	22.5	45	67.5	90	
0	1770	1770	1770	1770	1770	
5	1754	1722	1709	1734	1747	93
15	1698	1680	1688	1680	1692	403
25	1588	1593	1577	1553	1519	670
35	1404	1401	1360	1332	1305	835
45	1069	1054	1006	987	996	818
55	588	604	649	680	690	634
65	344	363	414	449	461	444
75	202	194	234	256	268	285
85	44	46	61	60	62	108
90	5	7	11	10	8	

COEFFICIENTS OF UTILIZATION (%)

Ceiling	80				70				50			
	70	50	30	10	70	50	30	10	50	30	10	
Wall	70	50	30	10	70	50	30	10	50	30	10	
0	95	95	95	95	93	93	93	93	88	88	88	
1	87	84	81	78	85	82	79	76	79	76	74	
2	80	74	69	64	78	72	68	64	69	66	62	
3	73	65	59	54	71	64	58	54	62	57	53	
4	67	58	52	47	66	57	51	46	55	50	46	
5	62	53	46	41	61	52	45	40	50	44	40	
6	58	48	41	36	56	47	40	36	45	40	35	
7	54	43	37	32	52	43	36	32	41	36	32	
8	50	40	33	29	49	39	33	29	38	32	28	
9	47	36	30	26	46	36	30	26	35	30	26	
10	44	34	28	24	43	33	27	24	33	27	23	

Based on floor reflectance of 20

LUMINANCE DATA (CD/M²)

Vertical Angle	Horizontal Angles		
	0	45	90
45	3527	3123	3276
55	2252	2290	2629
65	1627	1753	2166t
75	1301	1288	1706
85	459	504	643

2 T5HO



with **VL_{opti}c™**

PHOTOMETRIC CURVE

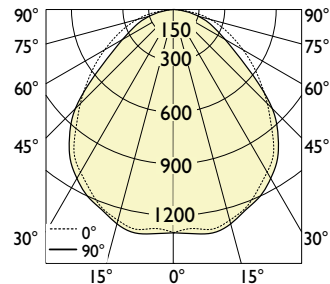

Test Lamp: 2xF24T5HO
 IES FILE: DUO22-VL-T5HO-2.ies

Efficiency: 83.1%

CANDELA DISTRIBUTION

Vertical Angle	Horizontal Angles					Zonal Lumens
	0	22.5	45	67.5	90	
0	1301	1301	1301	1301	1301	
5	1312	1350	1303	1293	1281	70
15	1294	1281	1276	1275	1272	306
25	1200	1192	1189	1163	1163	506
35	1060	1044	1030	1029	1020	633
45	817	808	775	780	776	631
55	454	476	507	549	566	499
65	274	287	336	368	381	359
75	154	154	188	213	225	230
85	35	37	48	48	47	87
90	4	5	9	9	6	

COEFFICIENTS OF UTILIZATION (%)

Ceiling	80				70				50			
	70	50	30	10	70	50	30	10	50	30	10	
Wall	70	50	30	10	70	50	30	10	50	30	10	
0	99	99	99	99	97	97	97	97	92	92	92	
1	91	87	84	81	89	85	82	80	82	79	77	
2	83	77	71	67	81	75	70	66	72	68	65	
3	76	68	61	56	74	67	61	56	64	59	55	
4	70	61	54	48	68	60	53	48	57	52	47	
5	65	54	47	42	63	54	47	42	52	46	41	
6	60	49	42	37	58	48	42	37	47	41	36	
7	56	45	38	33	54	44	37	33	43	37	32	
8	52	41	34	29	51	40	34	29	39	33	29	
9	49	38	31	27	47	37	31	27	36	30	26	
10	46	35	28	24	45	34	28	24	34	28	24	

Based on floor reflectance of 20

LUMINANCE DATA (CD/M²)

Vertical Angle	Horizontal Angles		
	0	45	90
45	2697	2405	2553
55	1738	1786	2159
65	1296	1423	1790
75	986	1032	1432
85	366	391	489

i All IES files are available for download at: www.axislighting.com

PHOTOMETRIC DATA

4 T5HO



with **VLoptic™**

PHOTOMETRIC CURVE

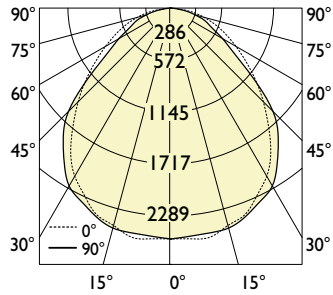

Test Lamp: 4xF24T5HO
 IES FILE: DUO22-VL-T5HO-4.ies

Efficiency: 79.5%

CANDELA DISTRIBUTION

Vertical Angle	Horizontal Angles					Zonal Lumens
	0	22.5	45	67.5	90	
0	2543	2543	2543	2543	2543	
5	2523	2530	2556	2575	2551	137
15	2508	2495	2502	2498	2478	597
25	2352	2346	2319	2296	2277	992
35	2068	2064	2017	1969	1942	1234
45	1610	1569	1498	1475	1459	1218
55	865	893	963	1011	1025	937
65	513	535	614	659	682	661
75	296	287	351	379	390	423
85	67	69	93	90	84	160
90	8	9	16	15	14	

COEFFICIENTS OF UTILIZATION (%)

Ceiling	80				70				50			
	70	50	30	10	70	50	30	10	50	30	10	
Wall												
0	95	95	95	95	93	93	93	93	88	88	88	
1	87	84	81	78	85	82	79	76	79	76	74	
2	80	74	69	64	78	72	68	64	69	66	62	
3	73	65	59	54	71	64	58	54	62	57	53	
4	67	58	52	47	66	57	51	46	55	50	46	
5	62	52	46	41	61	52	45	40	50	44	40	
6	58	48	41	36	56	47	40	36	45	40	35	
7	54	43	37	32	52	43	36	32	41	36	32	
8	50	40	33	29	49	39	33	29	38	32	28	
9	47	36	30	26	46	36	30	26	35	30	26	
10	44	34	28	24	43	33	27	23	33	27	23	

Based on floor reflectance of 20

LUMINANCE DATA (CD/M²)

Vertical Angle	Horizontal Angles		
	0	45	90
45	5315	4649	4800
55	3311	3396	3907
65	2422	2597	3203
75	1900	1926	2487
85	703	760	874

2 T8



with **VLoptic™**

PHOTOMETRIC CURVE

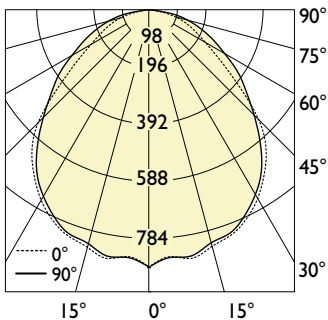

Test Lamp: 2xF17T8
 IES FILE: DUO22-VL-T8-2.ies

Efficiency: 81.3%

CANDELA DISTRIBUTION

Vertical Angle	Horizontal Angles					Zonal Lumens
	0	22.5	45	67.5	90	
0	882	882	882	882	882	
5	848	855	861	881	851	46
15	839	837	844	838	827	200
25	793	787	774	778	780	334
35	693	691	682	681	677	418
45	540	529	515	517	516	418
55	305	317	340	368	379	332
65	184	191	218	244	250	237
75	105	102	123	140	147	152
85	22	24	31	31	31	57
90	2	4	6	5	4	

COEFFICIENTS OF UTILIZATION (%)

Ceiling	80				70				50			
	70	50	30	10	70	50	30	10	50	30	10	
Wall												
0	97	97	97	97	95	95	95	95	90	90	90	
1	89	85	82	79	87	84	81	78	80	78	76	
2	82	75	70	66	79	74	69	65	71	67	63	
3	75	67	61	55	73	65	59	55	63	58	54	
4	69	59	52	47	67	58	52	47	56	51	46	
5	63	53	46	41	62	52	46	41	51	45	40	
6	59	48	41	36	57	47	41	36	46	40	36	
7	55	44	37	32	53	43	37	32	42	36	32	
8	51	40	33	29	50	40	33	29	39	33	29	
9	48	37	30	26	46	36	30	26	36	30	26	
10	45	34	28	24	44	34	28	24	33	27	23	

Based on floor reflectance of 20

LUMINANCE DATA (CD/M²)

Vertical Angle	Horizontal Angles		
	0	45	90
45	1783	1599	1699
55	1165	1200	1444
65	869	924	1173
75	675	678	934
85	233	256	324

i All IES files are available for download at: www.axislighting.com

PHOTOMETRIC DATA

4 T8

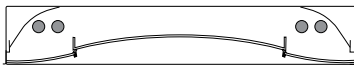

with **VL_{optic}**

PHOTOMETRIC CURVE

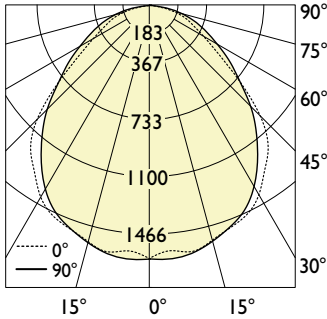

Test Lamp: 4x F17T8
 IES FILE: DUO22-VL-T8-4.ies

Efficiency: 74.5%

CANDELA DISTRIBUTION

Vertical Angle	Horizontal Angles					Zonal Lumens
	0	22.5	45	67.5	90	
0	1630	1630	1630	1630	1630	
5	1584	1622	1632	1650	1636	88
15	1567	1578	1586	1567	1574	376
25	1489	1472	1467	1463	1457	627
35	1302	1312	1282	1235	1224	781
45	1028	996	952	932	937	773
55	560	571	612	638	646	597
65	330	346	388	412	421	416
75	192	180	219	234	243	264
85	43	43	57	55	53	99
90	5	7	11	8	7	

COEFFICIENTS OF UTILIZATION (%)

Ceiling	80				70				50			
	70	50	30	10	70	50	30	10	50	30	10	
Wall												
0	89	89	89	89	87	87	87	87	83	83	83	
1	82	79	76	73	80	77	74	72	74	71	69	
2	75	69	64	60	73	68	63	60	65	61	58	
3	69	61	56	51	67	60	55	51	58	53	50	
4	63	55	49	44	62	54	48	44	52	47	43	
5	58	49	43	38	57	48	42	38	47	42	38	
6	54	45	38	34	53	44	38	33	43	37	33	
7	50	41	34	30	49	40	34	30	39	34	30	
8	47	37	31	27	46	37	31	27	36	30	27	
9	44	34	28	24	43	34	28	24	33	28	24	
10	41	31	26	22	40	31	26	22	31	25	22	

Based on floor reflectance of 20

LUMINANCE DATA (CD/M²)

Vertical Angle	Horizontal Angles		
	0	45	90
45	3393	2954	3082
55	2143	2158	2462
65	1558	1640	1979
75	1234	1205	1549
85	452	468	549

2 F25TT



with **VL_{optic}**

PHOTOMETRIC CURVE

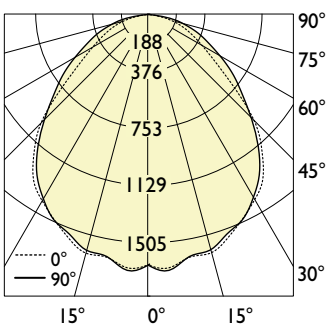

Test Lamp: 2x F25TT
 IES FILE: DUO22-VL-F25TT-2.ies

Efficiency: 80.0%

CANDELA DISTRIBUTION

Vertical Angle	Horizontal Angles					Zonal Lumens
	0	22.5	45	67.5	90	
0	1646	1646	1646	1646	1646	
5	1677	1683	1666	1672	1693	90
15	1629	1621	1614	1616	1609	386
25	1491	1506	1502	1488	1494	640
35	1334	1329	1313	1288	1294	800
45	1014	994	980	972	981	791
55	563	594	639	675	700	620
65	344	363	418	448	455	443
75	193	191	234	258	266	283
85	44	45	60	58	55	105
90	5	7	11	10	9	

COEFFICIENTS OF UTILIZATION (%)

Ceiling	80				70				50			
	70	50	30	10	70	50	30	10	50	30	10	
Wall												
0	96	96	96	96	93	93	93	93	89	89	89	
1	88	84	81	78	86	82	80	77	79	77	74	
2	80	74	69	65	78	73	68	64	70	66	62	
3	74	66	60	55	72	64	59	54	62	57	53	
4	68	59	52	47	66	58	51	46	56	50	46	
5	63	53	46	41	61	52	45	41	50	44	40	
6	58	48	41	36	56	47	40	36	46	40	35	
7	54	43	37	32	53	43	36	32	42	36	32	
8	50	40	33	29	49	39	33	29	38	32	28	
9	47	37	30	26	46	36	30	26	35	30	26	
10	44	34	28	24	43	33	27	23	33	27	23	

Based on floor reflectance of 20

LUMINANCE DATA (CD/M²)

Vertical Angle	Horizontal Angles		
	0	45	90
45	3346	3042	3227
55	2155	2253	2668
65	1626	1770	2136
75	1237	1288	1695
85	461	488	575

i All IES files are available for download at: www.axislighting.com

PHOTOMETRIC DATA

2 F40TT



with **VL_{opti}**

PHOTOMETRIC CURVE

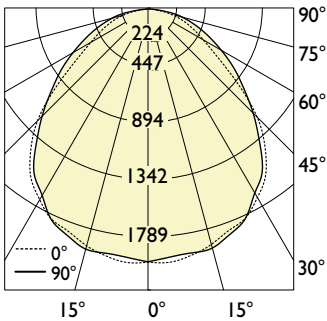

Test Lamp: 2xF40TT
 IES FILE: DUO22-VL-F40TT-2.ies

Efficiency: 79.5%

CANDELA DISTRIBUTION

Vertical Angle	Horizontal Angles					Zonal Lumens
	0	22.5	45	67.5	90	
0	1980	1980	1980	1980	1980	
5	1992	1953	1991	2013	1952	107
15	1914	1955	1927	1943	1942	461
25	1811	1798	1797	1799	1814	770
35	1610	1584	1577	1566	1567	963
45	1229	1213	1178	1171	1180	956
55	689	714	774	815	841	749
65	417	435	492	537	549	533
75	235	232	282	306	317	340
85	52	55	72	72	68	128
90	5	10	12	13	11	

COEFFICIENTS OF UTILIZATION (%)

Ceiling	80				70				50			
	70	50	30	10	70	50	30	10	50	30	10	
Wall	70	50	30	10	70	50	30	10	50	30	10	
0	95	95	95	95	93	93	93	93	89	89	89	
1	87	84	80	78	85	82	79	76	79	76	74	
2	80	74	69	64	78	72	67	63	69	65	62	
3	73	65	59	54	71	64	58	54	62	57	53	
4	67	58	52	46	66	57	51	46	55	50	46	
5	62	52	45	40	60	51	45	40	50	44	40	
6	58	47	40	36	56	47	40	35	45	39	35	
7	53	43	36	32	52	42	36	31	41	35	31	
8	50	39	33	28	49	39	33	28	38	32	28	
9	47	36	30	26	46	36	30	26	35	29	25	
10	44	34	27	23	43	33	27	23	32	27	23	

Based on floor reflectance of 20

LUMINANCE DATA (CD/M²)

Vertical Angle	Horizontal Angles		
	0	45	90
45	4058	3657	3882
55	2637	2729	3204
65	1971	2083	2576
75	1508	1550	2022
85	550	589	703

2 F50TT



with **VL_{opti}**

PHOTOMETRIC CURVE

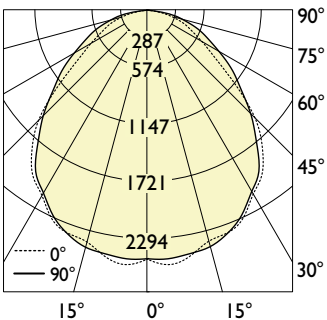

Test Lamp: 2xF50TT
 IES FILE: DUO22-VL-F50TT-2.ies

Efficiency: 79.5%

CANDELA DISTRIBUTION

Vertical Angle	Horizontal Angles					Zonal Lumens
	0	22.5	45	67.5	90	
0	2510	2510	2510	2510	2510	
5	2581	2572	2529	2480	2521	136
15	2421	2443	2476	2463	2477	586
25	2320	2288	2289	2298	2286	980
35	2039	2023	1996	2002	1988	1225
45	1570	1538	1502	1490	1503	1217
55	867	910	982	1037	1069	952
65	524	547	623	675	697	671
75	297	292	349	391	405	431
85	68	69	91	88	88	162
90	8	11	16	15	13	

COEFFICIENTS OF UTILIZATION (%)

Ceiling	80				70				50			
	70	50	30	10	70	50	30	10	50	30	10	
Wall	70	50	30	10	70	50	30	10	50	30	10	
0	95	95	95	95	93	93	93	93	89	89	89	
1	87	84	81	78	85	82	79	76	79	76	74	
2	80	74	69	64	78	72	68	64	69	65	62	
3	73	65	59	54	71	64	58	54	62	57	53	
4	67	58	52	47	66	57	51	46	55	50	46	
5	62	52	46	40	61	51	45	40	50	44	40	
6	58	47	41	36	56	47	40	35	45	39	35	
7	54	43	36	32	52	42	36	32	41	36	31	
8	50	39	33	28	49	39	33	28	38	32	28	
9	47	36	30	26	46	36	30	26	35	29	25	
10	44	34	27	23	43	33	27	23	32	27	23	

Based on floor reflectance of 20

LUMINANCE DATA (CD/M²)

Vertical Angle	Horizontal Angles		
	0	45	90
45	5182	4663	4945
55	3317	3461	4074
65	2473	2634	3275
75	1908	1918	2581
85	716	745	910

i All IES files are available for download at: www.axislighting.com

PHOTOMETRIC DATA

2 F55TT



with **VL_{opti}**

PHOTOMETRIC CURVE

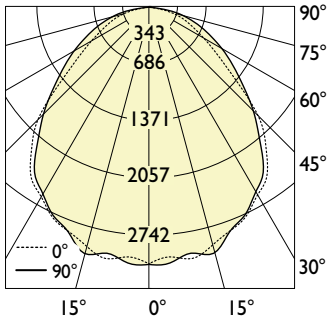

Test Lamp: 2x F55TT
 IES FILE: DUO22-VL-F55TT-2.ies

Efficiency: 80.2%

CANDELA DISTRIBUTION

Vertical Angle	Horizontal Angles					Zonal Lumens
	0	22.5	45	67.5	90	
0	3085	3085	3085	3085	3085	
5	3008	3080	3080	3039	3081	165
15	2966	2960	2971	2941	3058	709
25	2780	2771	2766	2775	2757	1184
35	2492	2435	2415	2404	2420	1480
45	1905	1868	1810	1804	1810	1473
55	1058	1088	1192	1257	1271	1151
65	634	668	759	827	852	818
75	365	352	430	469	497	522
85	79	85	111	108	107	196
90	11	13	18	18	16	

LUMINANCE DATA (CD/M²)

Vertical Angle	Horizontal Angles		
	0	45	90
45	6287	5617	5957
55	4047	4202	4844
65	2995	3210	4000
75	2345	2362	3165
85	834	907	1109

COEFFICIENTS OF UTILIZATION (%)

Ceiling	80			70			50				
	70	50	30	10	70	50	30	10	50	30	10
Wall											
0	96	96	96	96	93	93	93	93	89	89	89
1	88	84	81	78	86	83	80	77	79	77	75
2	81	74	69	65	78	73	68	64	70	66	63
3	74	66	60	55	72	65	59	54	62	57	53
4	68	59	52	47	66	58	51	47	56	50	46
5	63	53	46	41	61	52	45	41	50	44	40
6	58	48	41	36	57	47	40	36	46	40	35
7	54	43	37	32	53	43	36	32	42	36	32
8	50	40	33	29	49	39	33	29	38	32	28
9	47	37	30	26	46	36	30	26	35	30	26
10	44	34	28	24	43	33	27	23	33	27	23

Based on floor reflectance of 20

i All IES files are available for download at: www.axislighting.com