

PROJECT INFORMATION

Project:

Type:

Notes:

DIMENSIONS

SECTION VIEWS

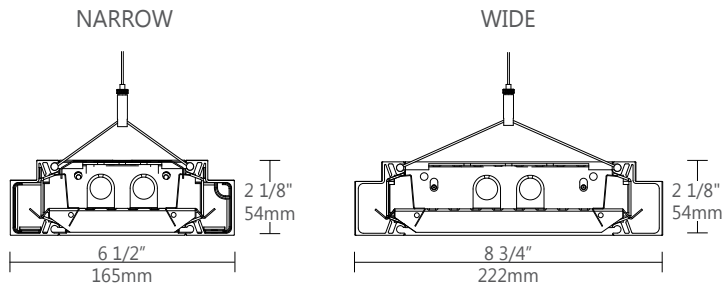

ORDERING CODE

1	2	3	4	5	6	7	8	9	10	11	12	13	14	15	16	17	18
---	---	---	---	---	---	---	---	---	----	----	----	----	----	----	----	----	----

PRODUCT SPECIFICATIONS

1 PRODUCT ID	2 OPTICS	3 LENGTH/FT	4 LAMP	5 LAMP CONFIGURATION	6 MR (OPTIONAL)
CU pendant wide	PL semi spec. para. louvers	4 4'	T5 T5	1 1 lamp	M16(#) MR 16 halogen
CUB pendant narrow	SB white solid baffles	8 8'	T5HO T5HO	2 2 lamps	M16LED(#) MR 16 LED
CUBA pendant narrow asymmetric ⁽¹⁾	P perforated	12 12'	T8 T8	3 3 lamps ⁽²⁾	
	SL slotted	S# System Run		4 4 lamps ⁽³⁾	
	B blank				
	VL vl optic				
	S satin lens				
(1) One lamp with satin lens only; available only with 0/0 reflectors				(2) Not available for T8 in CUB (3) Not available for T8 in CU, CUB	
				Add 9" per lamp. Specify quantity Requires 120V or 277V	

7 FINISH	8 UP LIGHT REFLECTOR	9 DOWN LIGHT REFLECTOR	10 VOLTAGE	11 BALLAST	12 CIRCUITS
AP aluminum paint	0 no reflector ⁽⁴⁾	0 no reflector ⁽⁷⁾	120 120V	D dimming	1 1 regular
W white	1 1 perf. white reflector ⁽⁶⁾	1 1 perf. white reflector ⁽⁹⁾	277 277V	E instant start ⁽¹¹⁾	2 2 regular
BLK black	2 2 perf. white reflectors ⁽⁶⁾	2 2 perf. white reflectors ⁽⁹⁾	347 347V ⁽¹⁰⁾	ERS program start	2A/B 2 alternating
C custom	3 3 perf. white reflectors ⁽⁵⁾⁽⁶⁾	3 3 perf. white reflectors ⁽⁸⁾⁽⁹⁾	UNV universal	BI bi-level dimming	+E(#) emergency section
		4 4 perf. white reflectors ⁽⁸⁾⁽⁹⁾			+NL(#) night light section ⁽¹²⁾
		BK blank ⁽⁷⁾⁽⁹⁾			+GTD(#) generator transfer device ⁽¹²⁾
		FP full perf. white reflector ⁽⁹⁾			+M MR
		HP half perf. white reflector ⁽⁹⁾			
	Only available with baffle and louver (4) Available for all optics (5) CU only (6) Available only with 0 reflector down See light distribution guide for further details	Only available with baffle and louver (7) Available for all optics (8) CU only (9) Available only with 0 reflector up See light distribution guide for further details	(10) Consult factory	(11) Available with T8 lamp only	(12) Specify quantity

13 HANGER	14 MOUNTING/SUSPENSION	15 BATTERY (OPTIONAL)	16 OTHER (OPTIONAL)	17 IC CONTROLS (OPTIONAL)	18 CUSTOM (OPTIONAL)
C aircraft cable	CA(#) drywall+cable length (36" std.)	B# battery pack 4' sections	D dust cover	DS# daylight sensor	C custom
D die cast	CT9(#) TB/TG 9/16+cable length (36" std.)		F fuse ⁽¹³⁾	OS# occupancy sensor	
	CT15(#) TB/TG15/16+cable length (36" std.)			DOS# daylight&occupancy sensor	
	CTS(#) ST+cable length (36" std.)				
	SA(#) drywall+stem length >48" (18" std.)				
	Specify quantity See ceiling mounting guide for further details	Requires 120V or 277V Please consult factory	(13) Requires 120V or 277V Please consult factory	Requires 8" blank. Specify quantity See integrated controls guide for further details	Please specify

● LIGHT DISTRIBUTION

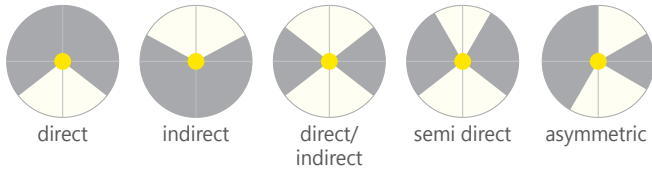

● SUSPENSION / MOUNTING SPACING

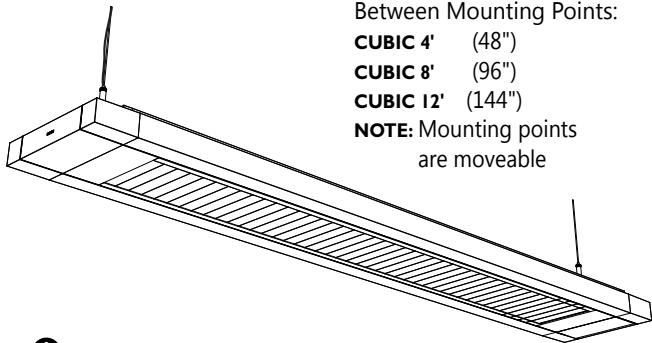

Between Mounting Points:

CUBIC 4' (48")

CUBIC 8' (96")

CUBIC 12' (144")

NOTE: Mounting points are moveable

i Row configuration and mounting spacing file is available for download at: www.axislighting.com

● MOUNTING OPTIONS

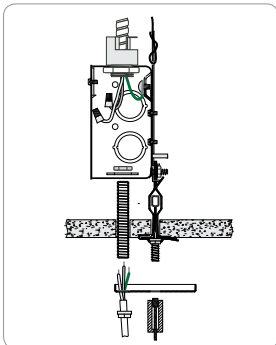

CT TILE CEILING - ON GRID

Mounting options are also available for slope ceiling and seismic bracing.

i Installation sheets for all mounting options are available at: www.axislighting.com

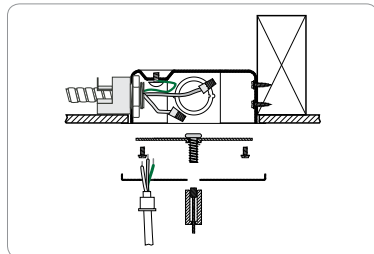

CA DRYWALL CEILING

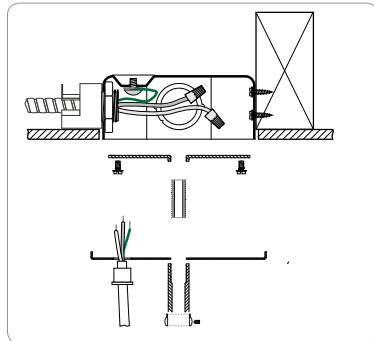

SA STEM MOUNT IN DRYWALL CEILING

● OTHER MOUNTING OPTIONS

CUBIC is also available with surface and wall mounted options.

i Specification sheets for surface and wall mounted CUBIC luminaires are available for download at www.axislighting.com

i All IES files for other lamping are available for download at www.axislighting.com

● CONSTRUCTION

End Cap	Die cast zinc (0.100" nominal)
Side Profile	Extruded aluminum (0.060" nominal)
Louvers	Die formed semi-specular aluminum (22 gauge)
Perforation / Slotted / Blank	Cold rolled metal sheet (20 gauge) with powder painted custom color
Baffles	Die formed aluminum (22 gauge) powder painted white
V_Loptic™	PMMA 92% transmissive lens
Satin	PMMA 68% transmissive lens
Interior Brackets	Die formed sheet steel (12 gauge)
Hanger	Aircraft cable Ø 1/16", Die cast (CU only)
Suspension	Aircraft cable or Ø 5/8" stem
Cable Grips	Quick Connecting/release

● WEIGHT

CU - WIDE

CU 4 ft 13 lbs / 5.7 kg

CU 8 ft 20 lbs / 9.3 kg

CU 12 ft 33 lbs / 15.0 kg

CUB - NARROW

CUB 4 ft 12 lbs / 5.6 kg

CU 8 ft 20 lbs / 9.1 kg

CU 12 ft 31 lbs / 14.1 kg

● CORNER SPECIFICATION

In addition to individual pendants and linear runs, the CUBIC luminaire can be specified with 90 degree corner, T or X junctions.

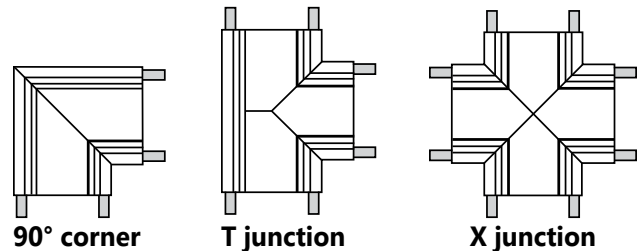

All systems requiring corner units must be specified as such at the time of order. Existing linear systems or luminaires cannot have corners added at a later date.

i Specifications sheets for all corner specification are available at: www.axislighting.com

● FINISH

Aluminium paint, Powder Coated and custom finishes are also available.

● ELECTRICAL

Ballast Electronic IS, Electronic Rapid Start, Dimming (0-10V, Line, EcoSystem, DALI), BI-level dimming
 With preinstalled ballast disconnect as per NEC & CEC

Emergency Emergency battery pack or emergency circuit

Voltage 120V, 277V, 347V, UNV

● APPROVALS

Certified to UL and CUL standards _{us}
 Meets NYC requirements
 Suitable for damp locations.

**DISTRIBUTIONS ASSUME
2 LAMPS**

These luminaires were designed with field adjustable optic reflectors. The quantity of these uplight and downlight reflectors control the distribution of uplight / downlight and can be added after installation.

i IES files and specific Light Distribution for baffles and louvers are available at: www.axislighting.com

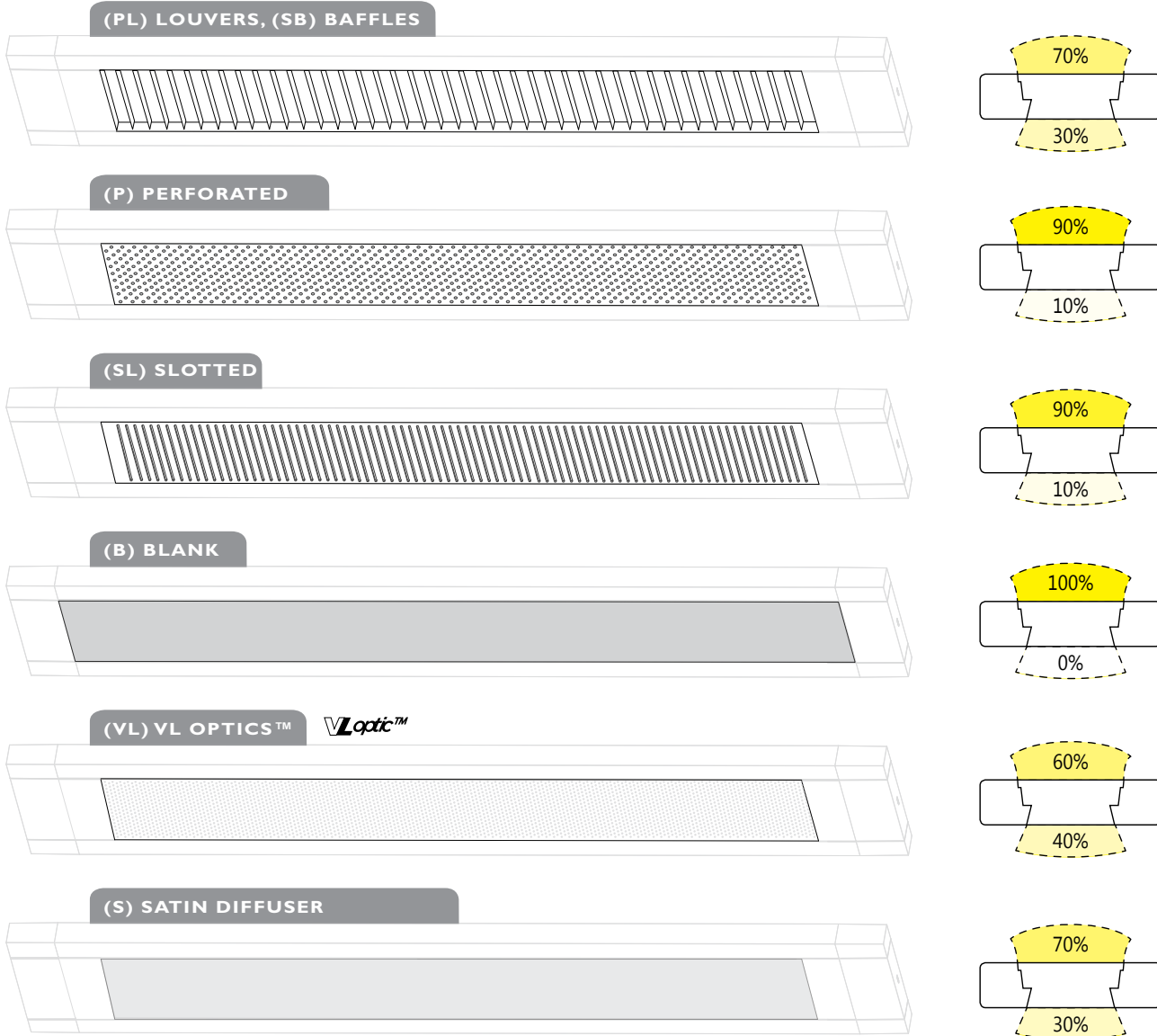

● ASYMMETRIC SPECIFICATION

For applications where asymmetric distribution is preferred we can use this option. However, this asymmetric distribution is NOT available with louvers or baffles, only for satin lens.

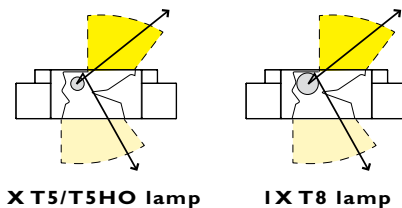

● INTEGRATED CONTROL OPTIONS

CUBIC luminaires allow the use of integrated controls such as daylight sensors (DS), occupancy sensors (OS), individual daylight sensors and occupancy sensors (DS+OS), and combination daylight/occupancy sensors (DOS). These options can be seamlessly integrated into our luminaires. The control system could be used to optimize the lighting of the space by reducing energy consumption through daylight harvesting and occupancy, thereby improving the overall interior environment and allowing for LEED credits.

- Consult factory for other options.
- Refer to IC brochure for more information.

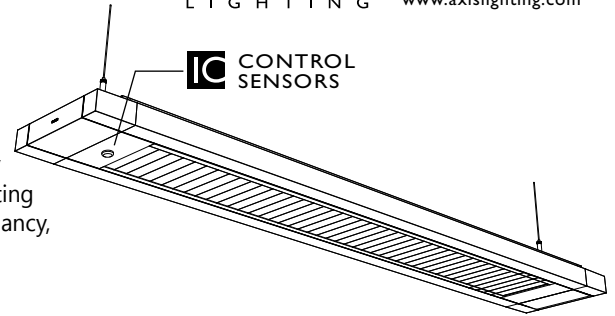

SENSORS	BRAND	Model	TYPE	CODE	COMPATIBLE DIMMING BALLAST
Daylight Sensor (DS)	Lutron	EC-DIR-WH	Daylight	LD	EcoSystem
	Wattstopper	FD-301	Daylight	WD	0-10V
	Philips	Luxsense	Daylight	PL	0-10V
Occupancy Sensor (OS)	Wattstopper	FS-205	PIR Occupancy	WP1	Programmed Rapid Start
		FS-355	PIR Occupancy	WP2	Programmed Rapid Start
		FS-155	PIR Occupancy	WP3	Programmed Rapid Start
		FS-505	Ultrasonic Occupancy	WU1	Programmed Rapid Start
		FS-505C	Ultrasonic Occupancy	WU2	Programmed Rapid Start
		FM-105	High Frequency Occupancy	WH	Programmed Rapid Start
Daylight & Occupancy Sensors (DOS)	Philips	Actilume	Daylight & PIR Occupancy	PA	DALI or 0-10V

● PHOTOMETRIC DATA

CUBIC WIDE

I T5

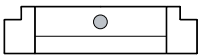

PHOTOMETRIC CURVE

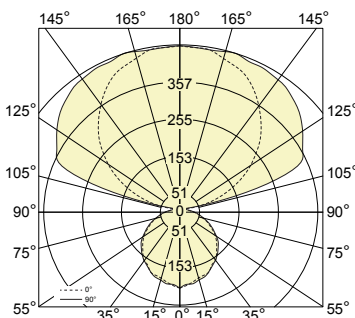

Test Lamp: 1x F28T5
IES FILE: CU-S-4-T5-1-0-0-70-30

Efficiency: 92.7%

CANDELA DISTRIBUTION

Vertical Angle	Horizontal Angles					Zonal Lumens
	0	22.5	45	67.5	90	
0	219	219	219	219	219	
5	213	211	210	208	210	10
15	199	202	204	205	204	29
25	192	189	192	192	192	44
35	173	171	172	174	173	54
45	145	147	147	150	151	57
55	117	117	119	121	121	53
65	83	85	86	86	86	43
75	49	50	51	51	52	27
85	16	16	15	15	16	8
90	4	3	3	3	3	
95	32	44	23	18	18	15
105	102	158	235	233	221	104
115	181	228	300	353	376	144
125	254	290	350	396	413	154
135	319	344	389	426	439	149
145	373	388	418	439	451	130
155	416	422	438	452	451	101
165	437	441	450	455	452	64
175	449	446	449	457	450	22
180	452	452	452	452	452	

COEFFICIENTS OF UTILIZATION (%)

Ceiling	80			70			50				
	70	50	30	10	70	50	30	10	50	30	10
Wall	70	50	30	10	70	50	30	10	50	30	10
0	94	94	94	94	84	84	84	84	65	65	65
1	86	82	78	74	76	73	70	66	57	55	52
2	78	71	66	59	69	64	59	53	50	46	42
3	71	62	56	48	63	56	50	44	44	40	35
4	65	55	48	40	57	49	43	36	39	34	29
5	59	49	41	34	53	44	37	31	34	30	25
6	54	43	36	29	48	39	33	26	31	26	21
7	50	39	32	25	45	35	29	23	28	23	18
8	46	35	28	22	41	32	26	20	25	21	16
9	43	32	25	19	38	29	23	17	23	18	14
10	40	29	23	17	36	26	21	15	21	17	13

Based on floor reflectance of 20

LUMINANCE DATA (CD/M²)

Vertical Angle	Horizontal Angles		
	0	45	90
45	1205	1217	1251
55	1202	1213	1234
65	1158	1197	1201
75	1113	1163	1181
85	1072	1026	1054

i All IES files for other lamping are available for download at: www.axislighting.com

● PHOTOMETRIC DATA

CUBIC WIDE

2 T5

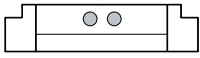

PHOTOMETRIC CURVE

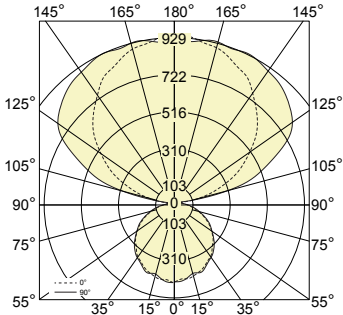

Test Lamp: 2x F28T5
 IES FILE: CU-S-4-T5-2-0-0-70-30

Efficiency: 91.6%

CANDELA DISTRIBUTION

Vertical Angle	Horizontal Angles					Zonal Lumens
	0	22.5	45	67.5	90	
0	442	442	442	442	442	
5	428	434	424	435	439	21
15	419	417	419	416	407	59
25	390	392	396	390	398	91
35	353	349	354	360	360	112
45	299	300	307	305	308	118
55	240	239	245	245	244	109
65	170	174	175	177	177	87
75	98	103	103	104	105	54
85	32	32	29	29	32	17
90	8	6	6	5	6	
95	64	83	57	40	35	31
105	210	303	362	384	387	178
115	373	456	572	613	621	266
125	516	587	689	770	798	303
135	648	701	778	841	864	298
145	751	789	842	886	899	263
155	830	859	888	915	924	205
165	893	900	914	916	926	129
175	929	928	925	917	901	44
180	925	925	925	925	925	

COEFFICIENTS OF UTILIZATION (%)

Ceiling	80			70			50				
	70	50	30	10	70	50	30	10	50	30	10
Wall	70	50	30	10	70	50	30	10	50	30	10
0	93	93	93	84	84	84	84	65	65	65	48
1	81	77	73	76	72	70	66	57	55	52	42
2	70	65	58	69	63	59	53	49	46	42	37
3	62	55	48	62	55	50	43	43	39	35	32
4	54	47	40	57	49	43	36	38	34	29	29
5	48	41	33	52	43	37	31	34	30	25	26
6	43	36	29	48	39	32	26	31	26	21	23
7	39	32	25	44	35	29	22	28	23	18	21
8	35	28	21	41	31	25	20	25	20	16	19
9	32	25	19	38	29	23	17	23	18	14	17
10	29	22	17	35	26	20	15	21	17	13	16

Based on floor reflectance of 20

LUMINANCE DATA (CD/M²)

Vertical Angle	Horizontal Angles		
	0	45	90
45	2486	2551	2557
55	2459	2503	2493
65	2364	2426	2454
75	2226	2343	2388
85	2154	1982	2131

CUBIC WIDE

3 T5

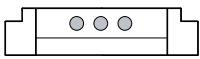

PHOTOMETRIC CURVE

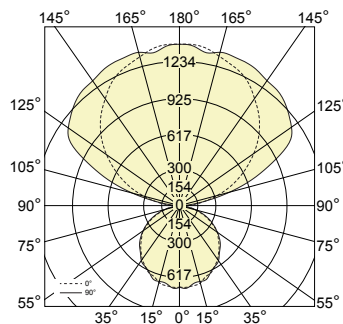

Test Lamp: 3x F28T5
 IES FILE: CU-S-4-T5-3-0-0-70-30

Efficiency: 91.0%

CANDELA DISTRIBUTION

Vertical Angle	Horizontal Angles					Zonal Lumens
	0	22.5	45	67.5	90	
0	694	694	694	694	694	
5	698	703	708	690	706	33
15	683	668	671	680	669	96
25	633	623	630	634	628	146
35	564	563	573	571	579	179
45	479	486	490	491	492	189
55	394	387	393	399	397	177
65	276	277	284	289	288	140
75	156	166	169	169	168	88
85	54	52	48	49	47	27
90	13	8	8	7	7	
95	102	97	59	43	38	37
105	322	445	470	436	421	228
115	554	668	840	884	874	386
125	772	863	1013	1122	1171	446
135	968	1022	1137	1230	1268	437
145	1121	1158	1237	1303	1309	386
155	1254	1248	1299	1339	1355	301
165	1325	1330	1339	1347	1363	190
175	1388	1360	1371	1374	1375	66
180	1385	1385	1385	1385	1385	

COEFFICIENTS OF UTILIZATION (%)

Ceiling	80			70			50				
	70	50	30	10	70	50	30	10	50	30	10
Wall	70	50	30	10	70	50	30	10	50	30	10
0	93	93	93	93	84	84	84	84	66	66	66
1	85	81	77	73	76	73	70	66	57	55	53
2	77	70	65	58	69	63	59	53	50	47	43
3	70	62	55	48	63	55	50	43	44	40	35
4	64	54	47	40	57	49	43	36	39	34	29
5	58	48	41	33	52	43	37	31	34	30	25
6	54	43	36	28	48	39	33	26	31	26	21
7	50	39	31	25	44	35	29	23	28	23	19
8	46	35	28	21	41	32	25	20	25	21	16
9	43	32	25	19	38	29	23	17	23	19	14
10	40	29	22	17	35	26	21	15	21	17	13

Based on floor reflectance of 20

LUMINANCE DATA (CD/M²)

Vertical Angle	Horizontal Angles		
	0	45	90
45	3976	4067	4089
55	4035	4024	4063
65	3828	3944	3998
75	3537	3837	3803
85	3618	3257	3187

i All IES files for other lamping are available for download at: www.axislighting.com

● PHOTOMETRIC DATA

CUBIC WIDE

1 T8

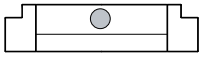

PHOTOMETRIC CURVE

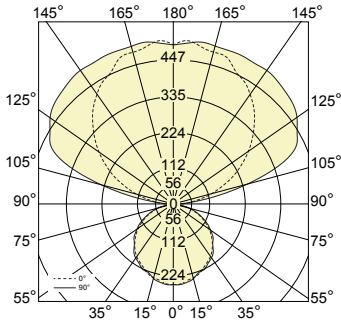

Test Lamp: 1x F32T8
 IES FILE: CU-S-4-T8-1-0-0-70-30

Efficiency: 92.0%

CANDELA DISTRIBUTION

Vertical Angle	Horizontal Angles					Zonal Lumens
	0	22.5	45	67.5	90	
0	245	245	245	245	245	
5	244	237	241	241	246	12
15	232	229	234	233	235	33
25	215	216	217	215	220	50
35	196	195	196	198	201	62
45	168	168	167	169	169	65
55	134	134	135	137	138	61
65	94	95	99	99	99	48
75	54	57	58	58	58	30
85	18	17	18	17	17	9
90	5	4	3	3	3	
95	36	49	34	27	23	19
105	114	176	234	230	224	107
115	199	250	330	389	411	158
125	278	319	387	440	460	170
135	349	376	427	470	485	164
145	409	429	457	486	499	144
155	448	462	481	493	500	111
165	481	488	495	495	500	70
175	502	489	500	489	495	24
180	487	487	487	487	487	

COEFFICIENTS OF UTILIZATION (%)

Ceiling	80			70			50				
	70	50	30	10	70	50	30	10	50	30	10
Wall	70	50	30	10	70	50	30	10	50	30	10
0	94	94	94	94	84	84	84	84	65	65	65
1	85	81	78	73	76	73	70	66	57	55	52
2	77	71	65	59	69	63	59	53	50	46	42
3	70	62	55	48	63	56	50	44	43	40	35
4	64	55	48	40	57	49	43	36	38	34	29
5	59	48	41	34	52	44	37	31	34	30	25
6	54	43	36	29	48	39	33	26	31	26	21
7	50	39	32	25	44	35	29	23	28	23	18
8	46	35	28	21	41	32	26	20	25	21	16
9	43	32	25	19	38	29	23	17	23	18	14
10	40	29	23	17	36	26	21	15	21	17	13

Based on floor reflectance of 20

LUMINANCE DATA (CD/M²)

Vertical Angle	Horizontal Angles		
	0	45	90
45	1391	1390	1406
55	1368	1382	1415
65	1305	1372	1376
75	1225	1306	1324
85	1202	1186	1155

CUBIC WIDE

2 T8

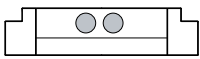

PHOTOMETRIC CURVE

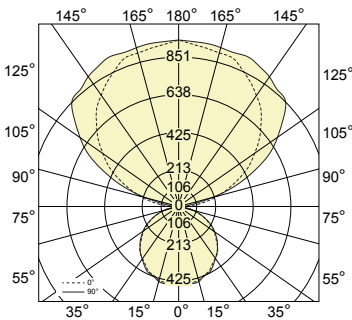

Test Lamp: 2x F32T8
 IES FILE: CU-S-4-T8-2-0-0-70-30

Efficiency: 90.4%

CANDELA DISTRIBUTION

Vertical Angle	Horizontal Angles					Zonal Lumens
	0	22.5	45	67.5	90	
0	503	503	503	503	503	
5	500	499	510	505	537	24
15	488	500	488	494	497	70
25	460	459	458	462	460	107
35	408	410	414	420	413	130
45	352	355	354	360	358	138
55	280	280	287	289	289	128
65	197	204	204	206	208	102
75	113	120	122	121	124	64
85	38	36	36	36	34	20
90	10	7	6	6	5	
95	74	80	64	54	49	35
105	234	322	357	349	343	174
115	408	498	595	632	644	280
125	572	640	754	834	847	330
135	709	763	857	919	944	326
145	828	865	920	971	995	288
155	914	937	971	992	1005	223
165	983	981	1006	1008	1022	142
175	1010	1004	1012	1013	1015	48
180	1024	1024	1024	1024	1024	

COEFFICIENTS OF UTILIZATION (%)

Ceiling	80			70			50				
	70	50	30	10	70	50	30	10	50	30	10
Wall	70	50	30	10	70	50	30	10	50	30	10
0	93	93	93	93	83	83	83	83	65	65	65
1	84	80	77	72	75	72	69	65	57	55	52
2	77	70	64	58	68	63	58	53	49	46	42
3	70	61	55	47	62	55	50	43	43	40	35
4	64	54	47	39	57	49	43	36	38	34	29
5	58	48	41	33	52	43	37	30	34	30	25
6	53	43	36	28	48	39	32	26	31	26	21
7	49	38	31	24	44	35	29	22	28	23	18
8	46	35	28	21	41	31	25	20	25	21	16
9	42	31	25	19	38	28	23	17	23	18	14
10	39	29	22	16	35	26	20	15	21	17	13

Based on floor reflectance of 20

LUMINANCE DATA (CD/M²)

Vertical Angle	Horizontal Angles		
	0	45	90
45	2919	2941	2977
55	2864	2940	2959
65	2742	2836	2889
75	2554	2765	2805
85	2546	2426	2277

i All IES files for other lamping are available for download at: www.axislighting.com

● PHOTOMETRIC DATA

CUBIC WIDE

1 T5

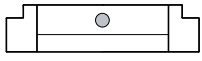

with **VL^optic™**

PHOTOMETRIC CURVE

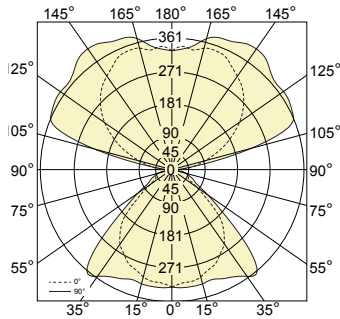

Test Lamp: 1xF28T5
 IES FILE: CU-VL-4-T5-1-0-0-60-40

Efficiency: 93.7%

CANDELA DISTRIBUTION

Vertical Angle	Horizontal Angles					Zonal Lumens
	0	22.5	45	67.5	90	
0	322	322	322	322	322	
5	312	314	312	319	325	15
15	305	311	317	323	324	45
25	284	292	305	321	330	71
35	250	267	304	338	357	95
45	187	223	266	283	289	98
55	84	93	107	115	123	47
65	49	59	58	56	66	29
75	45	44	43	39	42	22
85	16	15	16	16	14	8
90	4	3	4	5	4	
95	32	42	23	18	16	15
105	90	148	228	228	216	100
115	159	204	275	342	367	135
125	226	262	313	352	375	138
135	279	309	357	380	383	133
145	314	340	376	398	406	116
155	345	358	379	389	391	87
165	348	356	370	374	375	52
175	342	338	340	341	335	16
180	328	328	328	328	328	

COEFFICIENTS OF UTILIZATION (%)

Ceiling	80				70				50			
	70	50	30	10	70	50	30	10	50	30	10	
Wall	70	50	30	10	70	50	30	10	50	30	10	
0	97	97	97	97	88	88	88	88	71	71	71	
1	89	85	82	77	80	77	74	70	62	60	57	
2	81	75	69	63	73	68	63	57	55	52	47	
3	74	66	59	52	67	60	54	48	49	45	40	
4	68	58	51	44	61	53	47	40	43	39	34	
5	62	52	45	37	56	47	41	34	39	34	29	
6	57	47	39	32	52	43	36	30	35	30	25	
7	53	42	35	28	48	38	32	26	32	27	22	
8	49	38	31	24	44	35	29	23	29	24	19	
9	46	35	28	21	41	32	26	20	26	22	17	
10	43	32	25	19	39	29	23	18	24	20	15	

Based on floor reflectance of 20

LUMINANCE DATA (CD/M²)

Vertical Angle	Horizontal Angles		
	0	45	90
45	1556	2212	2397
55	860	1091	1257
65	685	800	918
75	1010	979	963
85	1045	1046	938

CUBIC WIDE

2 T5

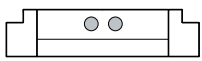

with **VL^optic™**

PHOTOMETRIC CURVE

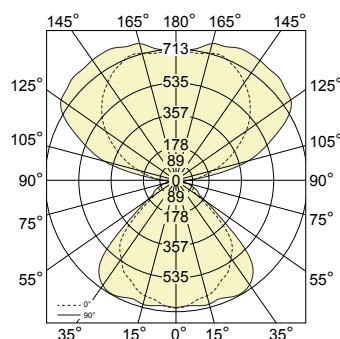

Test Lamp: 2xF28T5
 IES FILE: CU-VL-4-T5-2-0-0-60-40

Efficiency: 92.7%

CANDELA DISTRIBUTION

Vertical Angle	Horizontal Angles					Zonal Lumens
	0	22.5	45	67.5	90	
0	683	683	683	683	683	
5	676	653	660	674	676	32
15	641	662	658	685	688	95
25	587	611	650	668	691	149
35	515	562	627	671	689	193
45	400	446	513	545	549	192
55	171	182	209	219	224	91
65	100	113	111	111	131	56
75	92	88	85	81	86	46
85	32	29	32	33	28	17
90	7	7	9	11	9	
95	64	80	55	38	34	30
105	189	284	350	371	377	171
115	325	411	539	586	594	248
125	458	529	634	716	761	279
135	569	626	707	764	793	269
145	649	700	747	791	799	233
155	706	731	768	802	799	177
165	721	736	762	762	775	107
175	708	699	716	704	719	34
180	724	724	724	724	724	

COEFFICIENTS OF UTILIZATION (%)

Ceiling	80				70				50			
	70	50	30	10	70	50	30	10	50	30	10	
Wall	70	50	30	10	70	50	30	10	50	30	10	
0	96	96	96	96	87	87	87	87	70	70	70	
1	88	84	81	76	80	76	74	70	62	60	57	
2	81	74	69	62	73	67	63	57	55	51	47	
3	74	65	59	52	67	59	54	48	48	44	40	
4	68	58	51	43	61	53	47	40	43	39	34	
5	62	52	45	37	56	47	41	34	39	34	29	
6	57	46	39	32	52	42	36	30	35	30	25	
7	53	42	35	28	48	38	32	26	32	27	22	
8	49	38	31	24	44	35	29	23	29	24	19	
9	45	34	28	21	41	32	26	20	26	22	17	
10	42	32	25	19	38	29	23	18	24	20	15	

Based on floor reflectance of 20

LUMINANCE DATA (CD/M²)

Vertical Angle	Horizontal Angles		
	0	45	90
45	3324	4263	4562
55	1749	2140	2291
65	1384	1540	1821
75	2094	1939	1957
85	2163	2142	1902

i All IES files for other lamping are available for download at: www.axislighting.com

● PHOTOMETRIC DATA

CUBIC WIDE

3 T5

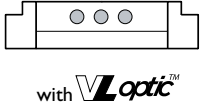

PHOTOMETRIC CURVE

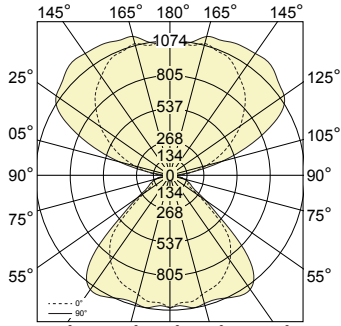

Test Lamp: 3xT5
 IES FILE: CU-VL-4-T5-3-0-0-60-40

Efficiency: 92.4%

CANDELA DISTRIBUTION

Vertical Angle	Horizontal Angles					Zonal Lumens
	0	22.5	45	67.5	90	
0	1063	1063	1063	1063	1063	
5	1024	1053	1033	1053	1048	50
15	989	1020	1041	1066	1064	147
25	941	967	1020	1039	1083	234
35	836	892	997	1067	1118	309
45	642	720	805	837	844	301
55	283	296	323	334	351	143
65	155	179	173	166	189	86
75	143	139	135	123	127	70
85	48	46	51	50	45	26
90	11	9	12	14	12	
95	100	94	58	40	35	35
105	288	425	462	426	409	220
115	488	607	801	858	853	365
125	683	779	937	1061	1119	413
135	854	922	1031	1141	1185	399
145	969	1020	1106	1170	1198	344
155	1065	1092	1140	1177	1182	262
165	1099	1109	1129	1147	1159	160
175	1073	1081	1077	1091	1069	52
180	1078	1078	1078	1078	1078	

COEFFICIENTS OF UTILIZATION (%)

Ceiling	80			70			50				
	70	50	30	10	70	50	30	10	50	30	10
Wall	70	50	30	10	70	50	30	10	50	30	10
0	97	97	97	97	88	88	88	88	71	71	71
1	88	84	81	77	80	77	74	70	62	60	58
2	81	74	69	62	73	68	63	57	55	52	48
3	74	66	59	52	67	60	54	48	49	45	40
4	68	58	51	44	61	53	47	41	44	39	34
5	62	52	45	37	56	48	41	35	39	35	30
6	57	47	39	32	52	43	36	30	35	31	26
7	53	42	35	28	48	39	32	26	32	27	22
8	49	38	31	24	45	35	29	23	29	24	20
9	46	35	28	22	41	32	26	20	27	22	18
10	43	32	25	19	39	29	23	18	24	20	16

Based on floor reflectance of 20

LUMINANCE DATA (CD/M²)

Vertical Angle	Horizontal Angles		
	0	45	90
45	5332	6687	7006
55	2895	3309	3590
65	2158	2402	2628
75	3244	3066	2872
85	3256	3423	3040

CUBIC WIDE

1 T8

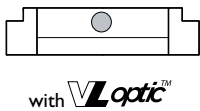

PHOTOMETRIC CURVE

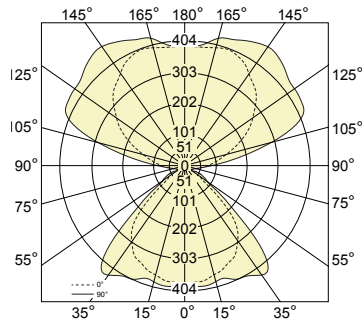

Test Lamp: 1xT8
 IES FILE: CU-VL-4-T8-1-0-0-60-40

Efficiency: 93.2%

CANDELA DISTRIBUTION

Vertical Angle	Horizontal Angles					Zonal Lumens
	0	22.5	45	67.5	90	
0	442	442	442	442	442	
5	428	434	424	435	439	21
15	419	417	419	416	407	59
25	390	392	396	390	398	91
35	353	349	354	360	360	112
45	299	300	307	305	308	118
55	240	239	245	245	244	109
65	170	174	175	177	177	87
75	98	103	103	104	105	54
85	32	32	29	29	32	17
90	8	6	6	5	6	
95	64	83	57	40	35	31
105	210	303	362	384	387	178
115	373	456	572	613	621	266
125	516	587	689	770	798	303
135	648	701	778	841	864	298
145	751	789	842	886	899	263
155	830	859	888	915	924	205
165	893	900	914	916	926	129
175	929	928	925	917	901	44
180	925	925	925	925	925	

COEFFICIENTS OF UTILIZATION (%)

Ceiling	80			70			50				
	70	50	30	10	70	50	30	10	50	30	10
Wall	70	50	30	10	70	50	30	10	50	30	10
0	93	93	93	84	84	84	84	65	65	65	48
1	81	77	73	76	72	70	66	57	55	52	42
2	70	65	58	69	63	59	53	49	46	42	37
3	62	55	48	62	55	50	43	43	39	35	32
4	54	47	40	57	49	43	36	38	34	29	29
5	48	41	33	52	43	37	31	34	30	25	26
6	43	36	29	48	39	32	26	31	26	21	23
7	39	32	25	44	35	29	22	28	23	18	21
8	35	28	21	41	31	25	20	25	20	16	19
9	32	25	19	38	29	23	17	23	18	14	17
10	29	22	17	35	26	20	15	21	17	13	16

Based on floor reflectance of 20

LUMINANCE DATA (CD/M²)

Vertical Angle	Horizontal Angles		
	0	45	90
45	2486	2551	2557
55	2459	2503	2493
65	2364	2426	2454
75	2226	2343	2388
85	2154	1982	2131

i All IES files for other lamping are available for download at: www.axislighting.com

● PHOTOMETRIC DATA

CUBIC WIDE

2 T8

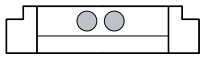

with **VL_{optic}**

PHOTOMETRIC CURVE

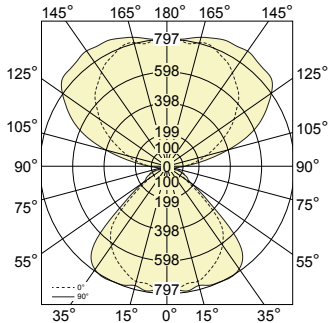

Test Lamp: 2x**F32T8**
 IES FILE: CU-VL-4-T8-2-0-0-60-40

Efficiency: **91.8%**

CANDELA DISTRIBUTION

Vertical Angle	Horizontal Angles					Zonal Lumens
	0	22.5	45	67.5	90	
0	763	763	763	763	763	
5	760	766	760	764	766	36
15	736	750	757	769	762	107
25	680	708	733	768	786	170
35	605	652	715	769	782	222
45	469	516	583	611	622	219
55	202	216	238	246	255	104
65	115	132	125	125	144	64
75	105	100	98	93	96	52
85	37	34	38	38	34	20
90	9	7	9	11	10	
95	72	77	64	52	48	35
105	215	301	344	342	337	167
115	355	452	567	609	624	263
125	508	582	702	784	798	305
135	640	689	778	839	873	297
145	724	770	836	873	896	258
155	790	817	852	882	887	196
165	820	826	842	862	855	119
175	818	790	814	807	818	39
180	842	842	842	842	842	

COEFFICIENTS OF UTILIZATION (%)

Ceiling	80			70			50				
	70	50	30	10	70	50	30	10	50	30	10
Wall	70	50	30	10	70	50	30	10	50	30	10
0	96	96	96	96	87	87	87	87	70	70	70
1	88	84	80	76	79	76	73	70	62	60	57
2	80	74	68	62	72	67	63	57	55	51	47
3	73	65	59	51	66	59	54	47	48	45	40
4	67	58	51	43	61	53	47	40	43	39	34
5	62	51	44	37	56	47	41	34	39	34	29
6	57	46	39	32	51	42	36	30	35	30	25
7	53	42	35	28	48	38	32	26	32	27	22
8	49	38	31	24	44	35	29	23	29	24	20
9	45	34	28	21	41	32	26	20	26	22	17
10	42	31	25	19	38	29	23	18	24	20	16

Based on floor reflectance of 20

LUMINANCE DATA (CD/M²)

Vertical Angle	Horizontal Angles		
	0	45	90
45	3894	4839	5162
55	2068	2436	2611
65	1599	1734	2001
75	2389	2213	2175
85	2466	2542	2280

CUBIC WIDE

1 T5

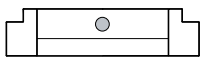

PHOTOMETRIC CURVE

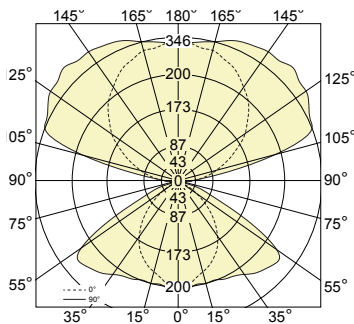

Test Lamp: 1x**F28T5**
 IES FILE: CU-PL-4-T5-1-0-0-70-30

Efficiency: **84.3%**

CANDELA DISTRIBUTION

Vertical Angle	Horizontal Angles					Zonal Lumens
	0	22.5	45	67.5	90	
0	248	248	248	248	248	
5	249	247	241	249	257	12
15	223	229	239	245	251	34
25	200	209	223	245	257	52
35	164	179	205	238	270	66
45	116	135	180	239	294	73
55	67	82	130	217	293	68
65	31	38	57	88	118	32
75	10	13	19	27	49	12
85	1	2	3	5	9	2
90	2	1	2	2	2	
95	32	41	21	17	16	14
105	83	146	223	223	212	98
115	135	195	274	329	350	129
125	193	237	308	354	376	133
135	239	275	326	368	389	124
145	275	298	341	367	381	105
155	307	317	344	361	371	79
165	327	327	342	353	350	48
175	335	329	341	330	337	16
180	340	340	340	340	340	

COEFFICIENTS OF UTILIZATION (%)

Ceiling	80			70			50				
	70	50	30	10	70	50	30	10	50	30	10
Wall	70	50	30	10	70	50	30	10	50	30	10
0	87	87	87	87	78	78	78	78	62	62	62
1	79	76	73	69	71	68	66	62	55	53	50
2	72	66	62	56	65	60	56	51	48	45	41
3	66	58	53	46	59	53	48	42	42	39	35
4	60	52	45	38	54	47	41	35	37	34	29
5	55	46	39	32	50	41	36	30	33	29	25
6	51	41	34	28	45	37	31	26	30	26	21
7	47	37	30	24	42	33	28	22	27	23	18
8	43	33	27	21	39	30	25	19	24	20	16
9	40	30	24	18	36	27	22	17	22	18	14
10	37	27	22	16	34	25	20	15	20	16	13

Based on floor reflectance of 20

LUMINANCE DATA (CD/M²)

Vertical Angle	Horizontal Angles		
	0	45	90
45	1217	1885	3086
55	862	1686	3786
65	543	992	2078
75	286	531	1403
85	121	268	768

i All IES files for other lamping are available for download at: www.axislighting.com

● PHOTOMETRIC DATA

CUBIC WIDE

2 T5

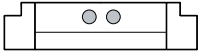

PHOTOMETRIC CURVE

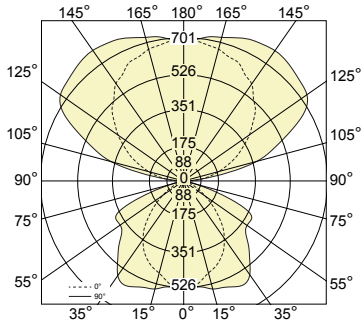

Test Lamp: 2x F28T5
 IES FILE: CU-PL-4-T5-2-0-0-70-30

Efficiency: 83.3%

CANDELA DISTRIBUTION

Vertical Angle	Horizontal Angles					Zonal Lumens
	0	22.5	45	67.5	90	
0	528	528	528	528	528	
5	526	527	526	522	528	25
15	470	485	510	521	552	72
25	426	437	477	541	576	113
35	350	377	446	514	569	141
45	242	278	361	403	454	135
55	135	158	215	295	382	104
65	60	73	105	204	353	73
75	20	25	37	54	90	23
85	3	4	6	10	15	4
90	3	3	3	4	5	
95	63	79	54	38	32	30
105	176	283	340	363	367	166
115	287	393	537	580	581	241
125	396	498	614	708	745	268
135	501	572	672	744	770	254
145	587	627	710	770	789	220
155	645	668	722	757	774	165
165	675	690	717	735	737	101
175	698	675	697	716	704	33
180	693	693	693	693	693	

COEFFICIENTS OF UTILIZATION (%)

Ceiling	80			70			50				
	70	50	30	10	70	50	30	10	50	30	10
Wall	70	50	30	10	70	50	30	10	50	30	10
0	86	86	86	86	77	77	77	77	61	61	61
1	78	75	72	68	70	68	65	62	54	52	50
2	72	66	61	55	64	59	55	50	47	45	41
3	65	58	52	46	59	52	47	42	42	38	34
4	60	51	45	38	54	46	41	35	37	33	29
5	55	46	39	32	49	41	36	30	33	29	25
6	50	41	34	28	45	37	31	26	30	26	21
7	46	37	30	24	42	33	28	22	27	23	19
8	43	33	27	21	39	30	25	19	24	20	16
9	40	30	24	18	36	27	22	17	22	18	14
10	37	28	22	16	34	25	20	15	21	17	13

Based on floor reflectance of 20

LUMINANCE DATA (CD/M²)

Vertical Angle	Horizontal Angles		
	0	45	90
45	2538	3789	4764
55	1747	2779	4935
65	1060	1844	6197
75	581	1069	2579
85	237	502	1281

CUBIC WIDE

3 T5

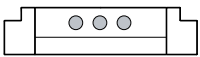

PHOTOMETRIC CURVE

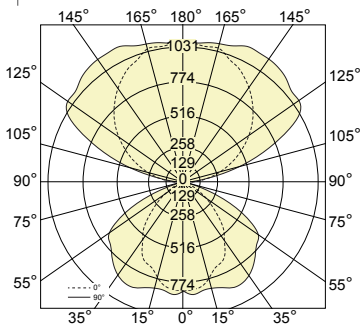

Test Lamp: 3x F28T5
 IES FILE: CU-PL-4-T5-3-0-0-70-30

Efficiency: 83.2%

CANDELA DISTRIBUTION

Vertical Angle	Horizontal Angles					Zonal Lumens
	0	22.5	45	67.5	90	
0	837	837	837	837	837	
5	829	846	834	842	867	40
15	763	766	791	830	844	113
25	683	692	753	841	895	178
35	549	607	698	814	878	223
45	390	447	571	673	784	221
55	220	255	362	522	705	180
65	99	117	164	281	427	102
75	31	40	56	76	119	33
85	5	6	9	14	24	6
90	5	3	4	5	6	
95	98	90	55	38	32	34
105	271	413	452	421	402	215
115	442	591	782	844	835	355
125	608	731	905	1027	1092	394
135	759	846	996	1093	1125	376
145	884	943	1060	1126	1159	326
155	986	1014	1085	1128	1160	249
165	1071	1050	1079	1085	1108	153
175	1076	1053	1076	1079	1082	51
180	1101	1101	1101	1101	1101	

COEFFICIENTS OF UTILIZATION (%)

Ceiling	80			70			50				
	70	50	30	10	70	50	30	10	50	30	10
Wall	70	50	30	10	70	50	30	10	50	30	10
0	86	86	86	86	78	78	78	78	62	62	62
1	79	75	72	68	71	68	66	62	55	53	51
2	72	66	61	55	65	60	56	51	48	45	42
3	66	58	52	46	59	53	48	42	43	39	35
4	60	51	45	38	54	47	41	35	38	34	30
5	55	46	39	33	49	42	36	30	34	30	25
6	51	41	34	28	46	37	32	26	30	26	22
7	47	37	30	24	42	34	28	22	27	23	19
8	43	33	27	21	39	30	25	20	25	21	17
9	40	30	24	19	36	28	22	17	23	19	15
10	37	28	22	16	34	25	20	15	21	17	13

Based on floor reflectance of 20

LUMINANCE DATA (CD/M²)

Vertical Angle	Horizontal Angles		
	0	45	90
45	4086	5993	8222
55	2838	4686	9120
65	1735	2870	7489
75	886	1601	3404
85	409	807	2058

i All IES files for other lamping are available for download at: www.axislighting.com

● PHOTOMETRIC DATA

CUBIC WIDE

1 T8

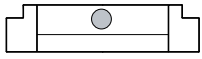

PHOTOMETRIC CURVE

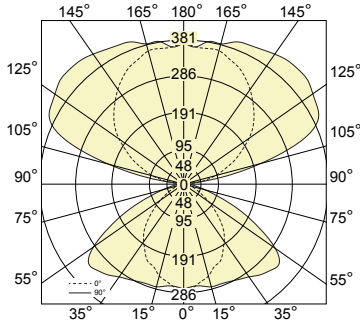

Test Lamp: 1x F32T8
 IES FILE: CU-PL-4-T8-1-0-0-70-30

Efficiency: 83.6%

CANDELA DISTRIBUTION

Vertical Angle	Horizontal Angles					Zonal Lumens
	0	22.5	45	67.5	90	
0	279	279	279	279	279	
5	276	272	271	277	273	13
15	253	254	257	269	283	37
25	227	234	246	269	286	58
35	186	200	231	268	302	74
45	135	154	204	266	325	83
55	76	93	145	225	294	73
65	35	43	65	105	158	38
75	11	14	21	29	52	13
85	2	2	4	6	10	2
90	2	2	2	2	2	
95	36	46	33	24	22	18
105	90	160	225	223	217	101
115	149	211	307	367	391	144
125	211	260	338	400	417	147
135	263	300	357	409	429	137
145	305	333	375	405	419	116
155	341	355	376	399	406	87
165	365	369	380	388	384	54
175	364	374	373	389	364	18
180	374	374	374	374	374	

COEFFICIENTS OF UTILIZATION (%)

Ceiling	80			70			50				
	70	50	30	10	70	50	30	10	50	30	10
Wall	70	50	30	10	70	50	30	10	50	30	10
0	86	86	86	86	77	77	77	77	61	61	61
1	79	75	72	68	71	68	65	62	54	52	50
2	72	66	61	55	64	59	55	50	48	45	41
3	65	58	52	45	59	52	47	42	42	38	34
4	60	51	45	38	54	46	41	35	37	33	29
5	55	45	39	32	49	41	35	30	33	29	25
6	50	41	34	27	45	37	31	25	30	25	21
7	46	36	30	24	42	33	27	22	27	23	18
8	43	33	27	21	39	30	24	19	24	20	16
9	40	30	24	18	36	27	22	17	22	18	14
10	37	27	21	16	33	25	20	15	20	16	13

Based on floor reflectance of 20

LUMINANCE DATA (CD/M²)

Vertical Angle	Horizontal Angles		
	0	45	90
45	1412	2143	3409
55	984	1869	3795
65	612	1133	2767
75	325	614	1501
85	128	300	865

CUBIC WIDE

2 T8

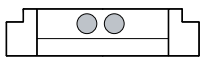

PHOTOMETRIC CURVE

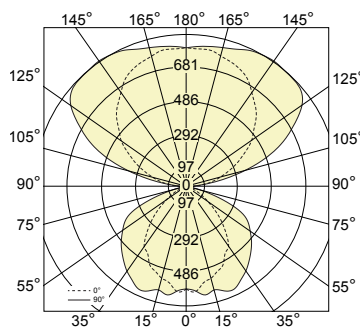

Test Lamp: 2x F32T8
 IES FILE: CU-PL-4-T8-2-0-0-70-30

Efficiency: 82.4%

CANDELA DISTRIBUTION

Vertical Angle	Horizontal Angles					Zonal Lumens
	0	22.5	45	67.5	90	
0	585	585	585	585	585	
5	603	589	591	606	599	29
15	543	542	572	608	612	82
25	495	510	550	604	647	129
35	420	434	491	539	591	155
45	288	326	394	451	522	153
55	155	183	254	351	446	122
65	69	85	120	217	344	78
75	23	29	43	61	109	26
85	3	5	7	11	18	5
90	5	3	3	4	4	
95	70	76	63	51	48	34
105	195	299	345	333	334	164
115	320	442	564	604	612	258
125	454	542	691	782	807	297
135	565	633	747	833	867	284
145	654	704	778	845	876	243
155	736	761	801	840	859	185
165	772	778	807	822	823	114
175	791	801	793	808	805	38
180	794	794	794	794	794	

COEFFICIENTS OF UTILIZATION (%)

Ceiling	80			70			50				
	70	50	30	10	70	50	30	10	50	30	10
Wall	70	50	30	10	70	50	30	10	50	30	10
0	85	85	85	85	77	77	77	77	61	61	61
1	78	74	71	67	70	67	65	61	54	52	50
2	71	65	60	55	64	59	55	50	47	44	41
3	65	57	52	45	58	52	47	41	42	38	34
4	59	51	45	38	53	46	41	35	37	33	29
5	54	45	39	32	49	41	35	30	33	29	25
6	50	40	34	28	45	37	31	25	30	26	21
7	46	36	30	24	41	33	28	22	27	23	19
8	43	33	27	21	38	30	25	19	24	20	16
9	40	30	24	18	36	27	22	17	22	18	14
10	37	27	22	16	33	25	20	15	20	17	13

Based on floor reflectance of 20

LUMINANCE DATA (CD/M²)

Vertical Angle	Horizontal Angles		
	0	45	90
45	3020	4137	5479
55	2006	3283	5766
65	1209	2109	6044
75	673	1223	3127
85	282	596	1519

i All IES files for other lamping are available for download at: www.axislighting.com

● PHOTOMETRIC DATA

CUBIC NARROW

1 T5

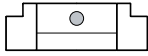

PHOTOMETRIC CURVE

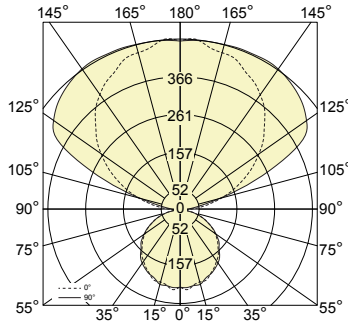

Test Lamp: 1xF28T5
 IES FILE: CUB-S-4-T5-1-0-0-70-30

Efficiency: 89.5%

CANDELA DISTRIBUTION

Vertical Angle	Horizontal Angles					Zonal Lumens
	0	22.5	45	67.5	90	
0	210	210	210	210	210	
5	217	212	213	214	212	10
15	203	205	207	206	209	29
25	192	190	194	191	193	44
35	170	174	171	175	177	55
45	144	148	149	152	148	58
55	115	116	118	119	119	53
65	82	84	86	85	82	42
75	48	49	50	48	48	26
85	15	15	14	13	13	8
90	3	3	3	2	2	
95	30	24	15	14	14	10
105	104	155	135	97	84	64
115	182	233	300	300	288	133
125	257	299	357	402	419	157
135	322	351	401	439	450	153
145	380	397	429	454	467	134
155	416	429	449	466	469	103
165	443	447	458	468	467	65
175	468	458	460	458	464	22
180	461	461	461	461	461	

COEFFICIENTS OF UTILIZATION (%)

Ceiling	80			70			50				
	70	50	30	10	70	50	30	10	50	30	10
Wall	70	50	30	10	70	50	30	10	50	30	10
0	91	91	91	91	82	82	82	82	64	64	64
1	83	79	76	71	74	71	68	64	55	53	51
2	75	69	63	57	67	62	57	52	48	45	41
3	69	60	54	47	61	54	49	42	42	39	34
4	63	53	46	39	56	48	42	35	37	33	29
5	57	47	40	33	51	42	36	30	33	29	24
6	53	42	35	28	47	38	32	26	30	25	21
7	48	38	31	24	43	34	28	22	27	22	18
8	45	34	27	21	40	31	25	19	24	20	16
9	42	31	24	18	37	28	22	17	22	18	14
10	39	28	22	16	35	26	20	15	20	16	12

Based on floor reflectance of 20

LUMINANCE DATA (CD/M²)

Vertical Angle	Horizontal Angles		
	0	45	90
45	1975	2038	2029
55	1950	2002	2014
65	1892	1965	1893
75	1791	1859	1797
85	1724	1512	1413

CUBIC NARROW

2 T5

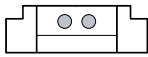

PHOTOMETRIC CURVE

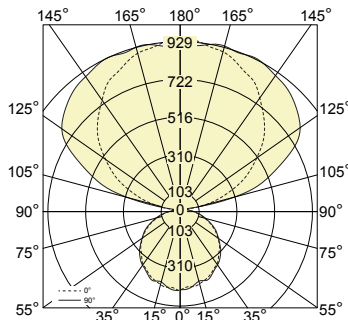

Test Lamp: 2xF28T5
 IES FILE: CUB-S-4-T5-2-0-0-70-30

Efficiency: 88.0%

CANDELA DISTRIBUTION

Vertical Angle	Horizontal Angles					Zonal Lumens
	0	22.5	45	67.5	90	
0	448	448	448	448	448	
5	450	452	447	452	441	21
15	435	434	427	433	442	61
25	407	406	407	411	414	95
35	362	365	366	366	365	115
45	313	311	314	313	314	121
55	248	250	251	253	252	113
65	176	179	178	182	179	89
75	100	103	104	102	103	54
85	33	31	28	28	27	16
90	6	5	4	4	4	
95	61	44	24	22	23	18
105	222	268	243	195	175	120
115	378	452	483	472	464	227
125	529	593	669	684	689	287
135	666	715	780	836	864	300
145	778	804	861	887	909	267
155	865	884	907	938	947	211
165	913	925	928	944	944	132
175	936	949	946	951	952	45
180	957	957	957	957	957	

COEFFICIENTS OF UTILIZATION (%)

Ceiling	80			70			50				
	70	50	30	10	70	50	30	10	50	30	10
Wall	70	50	30	10	70	50	30	10	50	30	10
0	90	90	90	90	81	81	81	81	64	64	64
1	82	78	75	70	73	70	67	64	55	53	51
2	74	68	63	56	67	61	57	51	48	45	41
3	68	60	53	46	60	54	48	42	42	39	34
4	62	53	46	38	55	47	41	35	37	33	29
5	57	47	40	32	51	42	36	30	33	29	24
6	52	42	35	28	46	38	32	25	30	25	21
7	48	37	31	24	43	34	28	22	27	23	18
8	44	34	27	21	40	31	25	19	24	20	16
9	41	31	24	18	37	28	22	17	22	18	14
10	38	28	22	16	34	25	20	15	20	16	12

Based on floor reflectance of 20

LUMINANCE DATA (CD/M²)

Vertical Angle	Horizontal Angles		
	0	45	90
45	4294	4312	4306
55	4200	4241	4266
65	4050	4096	4108
75	3762	3900	3878
85	3727	3143	3003

i All IES files for other lamping are available for download at: www.axislighting.com

● PHOTOMETRIC DATA

CUBIC NARROW

I T8

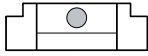

PHOTOMETRIC CURVE

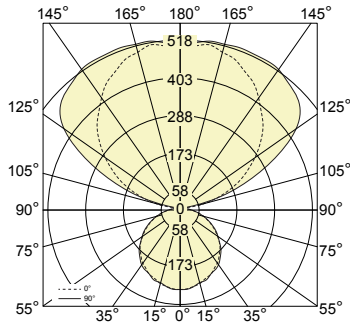

Test Lamp: IxF32T8
 IES FILE: CUB-S-4-T8-1-0-0-70-30

Efficiency: 88.4%

CANDELA DISTRIBUTION

Vertical Angle	Horizontal Angles					Zonal Lumens
	0	22.5	45	67.5	90	
0	247	247	247	247	247	
5	246	248	243	244	247	12
15	236	239	237	239	234	34
25	221	221	223	223	221	51
35	200	199	202	199	205	63
45	171	170	171	171	175	66
55	135	136	137	138	138	61
65	96	98	98	98	98	48
75	56	56	56	57	57	30
85	18	17	16	15	15	9
90	4	3	3	2	2	
95	33	27	17	15	15	11
105	114	158	142	123	117	71
115	202	254	301	288	278	134
125	282	327	390	429	434	169
135	356	388	443	478	492	168
145	413	438	474	504	516	148
155	459	479	491	515	517	114
165	489	493	505	515	514	71
175	493	502	504	508	503	24
180	506	506	506	506	506	

COEFFICIENTS OF UTILIZATION (%)

Ceiling	80			70			50				
	70	50	30	10	70	50	30	10	50	30	10
Wall	70	50	30	10	70	50	30	10	50	30	10
0	91	91	91	91	81	81	81	81	64	64	64
1	82	79	75	71	74	70	68	64	55	53	51
2	75	68	63	57	67	61	57	51	48	45	41
3	68	60	54	46	61	54	48	42	42	39	34
4	62	53	46	39	55	47	42	35	37	33	29
5	57	47	40	33	51	42	36	30	33	29	24
6	52	42	35	28	47	38	32	25	30	25	21
7	48	38	31	24	43	34	28	22	27	23	18
8	45	34	27	21	40	31	25	19	24	20	16
9	41	31	24	18	37	28	22	17	22	18	14
10	39	28	22	16	34	25	20	15	20	16	12

Based on floor reflectance of 20

LUMINANCE DATA (CD/M²)

Vertical Angle	Horizontal Angles		
	0	45	90
45	2348	2352	2402
55	2277	2317	2326
65	2199	2247	2248
75	2100	2111	2141
85	2008	1792	1667

CUBIC NARROW

I T5

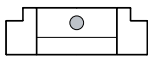

with **VLoptic™**

PHOTOMETRIC CURVE

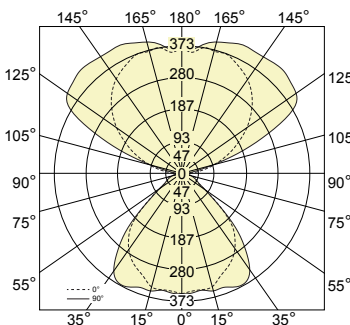

Test Lamp: IxF28T5
 IES FILE: CUB-VL-4-T5-1-0-0-60-40

Efficiency: 90.5%

CANDELA DISTRIBUTION

Vertical Angle	Horizontal Angles					Zonal Lumens
	0	22.5	45	67.5	90	
0	348	348	348	348	348	
5	341	347	351	347	347	17
15	339	331	332	347	351	48
25	305	309	335	351	362	77
35	268	289	328	345	344	100
45	201	224	227	225	221	86
55	88	89	92	88	86	40
65	45	53	49	45	49	24
75	43	41	40	35	33	20
85	14	13	15	14	12	8
90	3	3	5	5	4	
95	29	23	14	13	13	10
105	93	146	130	91	79	60
115	161	211	287	292	277	125
125	229	267	334	386	405	146
135	289	319	360	399	420	139
145	333	353	382	400	414	119
155	360	376	394	406	413	91
165	368	379	383	394	396	55
175	354	362	366	371	363	17
180	369	369	369	369	369	

COEFFICIENTS OF UTILIZATION (%)

Ceiling	80			70			50				
	70	50	30	10	70	50	30	10	50	30	10
Wall	70	50	30	10	70	50	30	10	50	30	10
0	94	94	94	94	85	85	85	85	68	68	68
1	86	82	79	75	78	75	72	68	60	58	56
2	79	72	67	61	71	66	61	56	53	50	46
3	72	64	58	51	65	58	53	47	47	44	39
4	66	57	50	43	60	52	46	40	42	38	33
5	61	51	44	37	55	46	40	34	38	34	29
6	56	46	39	32	51	42	36	29	34	30	25
7	52	41	34	28	47	38	32	26	31	27	22
8	48	37	31	24	43	34	28	23	28	24	19
9	45	34	27	21	40	31	25	20	26	22	17
10	42	31	25	19	38	29	23	18	24	20	15

Based on floor reflectance of 20

LUMINANCE DATA (CD/M²)

Vertical Angle	Horizontal Angles		
	0	45	90
45	2761	3122	3026
55	1480	1553	1456
65	1039	1130	1130
75	1595	1502	1232
85	1520	1692	1361

i All IES files for other lamping are available for download at: www.axislighting.com

● PHOTOMETRIC DATA

CUBIC NARROW

2 T5

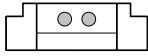

with **VL_{Optic}**

PHOTOMETRIC CURVE

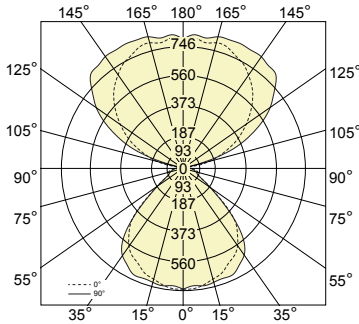

Test Lamp: 2x F28T5
 IES FILE: CUB-VL-4-T5-2-0-0-60-40

Efficiency: 89.4%

CANDELA DISTRIBUTION

Vertical Angle	Horizontal Angles					Zonal Lumens
	0	22.5	45	67.5	90	
0	752	752	752	752	752	
5	751	744	745	757	733	36
15	713	714	731	734	734	103
25	656	673	689	725	729	161
35	584	602	637	651	657	197
45	436	454	457	441	432	173
55	179	184	182	176	176	81
65	93	109	99	90	94	49
75	87	78	77	67	66	40
85	28	27	33	28	25	16
90	6	6	9	9	8	
95	58	41	23	22	22	17
105	200	253	233	188	169	114
115	344	415	464	454	449	215
125	479	542	633	656	659	269
135	606	648	721	784	808	277
145	699	732	774	821	835	243
155	760	784	816	837	839	187
165	794	814	820	832	833	116
175	801	796	799	791	820	38
180	789	789	789	789	789	

COEFFICIENTS OF UTILIZATION (%)

Ceiling	80			70			50				
	70	50	30	10	70	50	30	10	50	30	10
Wall	70	50	30	10	70	50	30	10	50	30	10
0	93	93	93	93	84	84	84	84	68	68	68
1	85	82	78	74	77	74	71	68	60	58	56
2	78	72	67	61	71	65	61	56	53	50	46
3	72	64	57	50	65	58	53	47	47	44	39
4	66	57	50	43	59	52	46	40	42	38	34
5	60	51	44	37	55	46	40	34	38	34	29
6	56	45	39	32	50	42	36	29	34	30	25
7	51	41	34	28	47	38	32	26	31	27	22
8	48	37	31	24	43	34	28	23	28	24	20
9	44	34	27	21	40	31	26	20	26	22	17
10	41	31	25	19	38	29	23	18	24	20	16

Based on floor reflectance of 20

LUMINANCE DATA (CD/M²)

Vertical Angle	Horizontal Angles		
	0	45	90
45	5987	6272	5929
55	3034	3073	2985
65	2132	2265	2168
75	3247	2884	2484
85	3066	3622	2773

CUBIC NARROW

1 T8

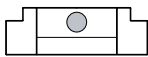

with **VL_{Optic}**

PHOTOMETRIC CURVE

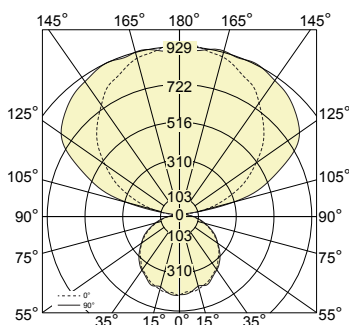

Test Lamp: 1x F32T8
 IES FILE: CUB-VL-4-T8-1-0-0-60-40

Efficiency: 89.7%

CANDELA DISTRIBUTION

Vertical Angle	Horizontal Angles					Zonal Lumens
	0	22.5	45	67.5	90	
0	384	384	384	384	384	
5	382	395	384	391	390	19
15	376	377	381	386	392	54
25	349	354	378	400	408	87
35	306	326	365	377	379	111
45	231	251	257	250	247	97
55	98	102	103	99	98	45
65	53	59	55	51	55	27
75	47	45	44	38	38	22
85	16	15	18	16	14	9
90	4	3	5	6	5	
95	31	26	16	15	14	11
105	105	148	138	120	113	68
115	178	235	286	276	273	127
125	253	299	364	412	419	158
135	320	354	405	445	459	154
145	370	394	430	452	468	133
155	404	416	442	453	459	101
165	424	422	435	443	449	62
175	420	412	418	424	430	20
180	410	410	410	410	410	

COEFFICIENTS OF UTILIZATION (%)

Ceiling	80			70			50				
	70	50	30	10	70	50	30	10	50	30	10
Wall	70	50	30	10	70	50	30	10	50	30	10
0	93	93	93	93	85	85	85	85	68	68	68
1	86	82	79	74	77	74	71	68	60	58	56
2	78	72	67	61	71	65	61	56	53	50	46
3	72	64	57	50	65	58	53	47	47	43	39
4	66	57	50	43	59	52	46	39	42	38	33
5	60	51	44	36	55	46	40	34	38	34	29
6	56	45	38	31	50	42	35	29	34	30	25
7	51	41	34	27	47	38	32	26	31	27	22
8	48	37	30	24	43	34	28	23	28	24	19
9	44	34	27	21	40	31	25	20	26	22	17
10	41	31	25	19	38	29	23	18	24	20	15

Based on floor reflectance of 20

LUMINANCE DATA (CD/M²)

Vertical Angle	Horizontal Angles		
	0	45	90
45	3164	3521	3388
55	1654	1735	1654
65	1226	1264	1257
75	1759	1660	1413
85	1735	2004	1525

i All IES files for other lamping are available for download at: www.axislighting.com

● **PHOTOMETRIC DATA**

CUBIC NARROW

1 T5

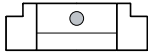

PHOTOMETRIC CURVE

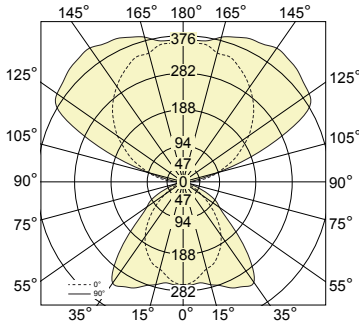

Test Lamp: 1x F28T5
 IES FILE: CUB-PL-4-T5-1-0-0-70-30

Efficiency: 81.4%

CANDELA DISTRIBUTION

Vertical Angle	Horizontal Angles					Zonal Lumens
	0	22.5	45	67.5	90	
0	264	264	264	264	264	
5	259	256	258	262	265	12
15	231	241	252	268	273	36
25	210	218	245	275	300	58
35	171	186	227	282	317	74
45	117	137	180	196	211	66
55	64	74	90	100	116	40
65	28	32	41	55	73	22
75	9	11	15	20	26	8
85	1	2	3	4	5	2
90	1	1	2	2	2	
95	30	22	14	14	14	10
105	88	146	129	92	79	60
115	148	209	284	290	277	124
125	205	258	328	377	397	142
135	257	297	360	401	414	135
145	299	326	373	407	422	115
155	333	347	377	398	409	86
165	345	360	371	383	388	53
175	360	362	368	368	368	17
180	363	363	363	363	363	

COEFFICIENTS OF UTILIZATION (%)

Ceiling	80			70			50				
	70	50	30	10	70	50	30	10	50	30	10
Wall	70	50	30	10	70	50	30	10	50	30	10
0	83	83	83	83	75	75	75	75	59	59	59
1	76	73	70	66	68	66	63	60	52	50	48
2	70	64	60	54	63	58	54	49	46	43	40
3	64	57	51	45	57	51	47	41	41	38	34
4	58	50	44	38	52	45	40	35	36	33	29
5	54	45	39	32	48	41	35	30	33	29	25
6	49	40	34	28	44	36	31	26	29	25	21
7	46	36	30	24	41	33	27	22	27	23	19
8	42	33	27	21	38	30	25	19	24	20	16
9	39	30	24	18	35	27	22	17	22	18	14
10	37	27	22	16	33	25	20	15	20	16	13

Based on floor reflectance of 20

LUMINANCE DATA (CD/M²)

Vertical Angle	Horizontal Angles		
	0	45	90
45	2330	3597	4213
55	1576	2221	2856
65	928	1353	2429
75	497	837	1409
85	191	454	770

CUBIC NARROW

2 T5

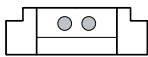

PHOTOMETRIC CURVE

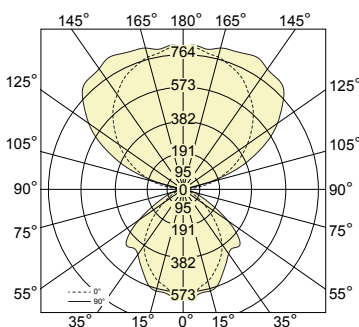

Test Lamp: 2x F28T5
 IES FILE: CUB-PL-4-T5-2-0-0-70-30

Efficiency: 80.2%

CANDELA DISTRIBUTION

Vertical Angle	Horizontal Angles					Zonal Lumens
	0	22.5	45	67.5	90	
0	596	596	596	596	596	
5	598	608	594	601	616	29
15	545	545	565	589	601	81
25	473	492	499	514	532	116
35	386	395	400	418	451	128
45	254	266	297	374	455	125
55	133	144	191	256	305	91
65	56	64	81	105	130	43
75	18	22	30	38	49	16
85	2	3	5	7	9	3
90	2	2	3	3	3	
95	61	42	23	21	21	17
105	194	251	232	188	168	113
115	323	416	460	453	445	213
125	448	537	630	648	658	266
135	564	631	718	785	809	273
145	655	697	781	820	835	239
155	732	752	802	849	848	185
165	777	789	806	822	830	114
175	809	802	796	799	820	38
180	807	807	807	807	807	

COEFFICIENTS OF UTILIZATION (%)

Ceiling	80			70			50				
	70	50	30	10	70	50	30	10	50	30	10
Wall	70	50	30	10	70	50	30	10	50	30	10
0	82	82	82	82	74	74	74	74	58	58	58
1	75	72	69	66	68	65	63	59	51	50	48
2	69	64	59	54	62	57	53	49	46	43	40
3	63	56	51	44	57	51	46	41	40	37	33
4	58	50	44	37	52	45	40	34	36	32	28
5	53	44	38	32	48	40	35	29	32	29	24
6	49	40	34	27	44	36	31	25	29	25	21
7	45	36	30	24	41	33	27	22	26	23	19
8	42	32	27	21	38	30	24	19	24	20	16
9	39	30	24	18	35	27	22	17	22	18	15
10	36	27	22	16	33	25	20	15	20	17	13

Based on floor reflectance of 20

LUMINANCE DATA (CD/M²)

Vertical Angle	Horizontal Angles		
	0	45	90
45	5066	5923	9072
55	3269	4694	7497
65	1872	2717	4344
75	978	1633	2667
85	394	883	1526

i All IES files for other lamping are available for download at: www.axislighting.com

● PHOTOMETRIC DATA

CUBIC NARROW

I T8

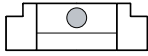

PHOTOMETRIC CURVE

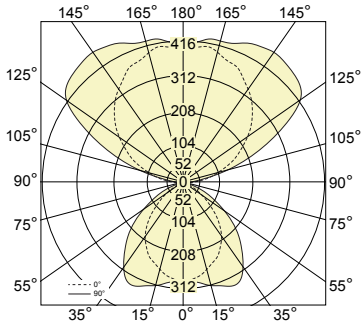

Test Lamp: 1x**F32T8**
 IES FILE: CUB-PL-4-T8-1-0-0-70-30

Efficiency: 80.3%

CANDELA DISTRIBUTION

Vertical Angle	Horizontal Angles					Zonal Lumens
	0	22.5	45	67.5	90	
0	296	296	296	296	296	
5	285	290	296	295	291	14
15	264	270	286	300	313	41
25	238	248	274	308	335	65
35	196	214	253	282	306	79
45	137	157	187	211	234	72
55	75	84	106	131	153	49
65	32	36	46	63	81	25
75	10	13	18	22	30	10
85	2	2	3	4	5	2
90	2	1	2	2	2	
95	31	26	17	14	15	11
105	96	149	137	119	115	68
115	165	231	288	275	269	126
125	228	288	363	414	419	156
135	287	330	397	443	457	149
145	334	367	415	449	468	128
155	375	390	418	444	454	97
165	396	407	419	430	432	59
175	401	413	403	418	415	20
180	411	411	411	411	411	

COEFFICIENTS OF UTILIZATION (%)

Ceiling	80			70			50				
	70	50	30	10	70	50	30	10	50	30	10
Wall	70	50	30	10	70	50	30	10	50	30	10
0	82	82	82	82	74	74	74	74	58	58	58
1	76	72	69	66	68	65	63	60	52	50	48
2	69	64	59	54	62	57	54	49	46	43	40
3	63	56	51	44	57	51	46	41	40	37	33
4	58	50	44	37	52	45	40	34	36	32	28
5	53	44	38	32	48	40	35	29	32	28	24
6	49	40	34	27	44	36	31	25	29	25	21
7	45	36	30	24	40	32	27	22	26	22	18
8	42	32	26	21	37	29	24	19	24	20	16
9	39	29	24	18	35	27	22	17	22	18	14
10	36	27	21	16	33	25	20	15	20	16	13

Based on floor reflectance of 20

LUMINANCE DATA (CD/M²)

Vertical Angle	Horizontal Angles		
	0	45	90
45	2720	3732	4668
55	1833	2593	3761
65	1060	1540	2700
75	553	953	1608
85	255	521	858

i All IES files for other lamping are available for download at: www.axislighting.com