

Project _____

Type _____

Notes _____

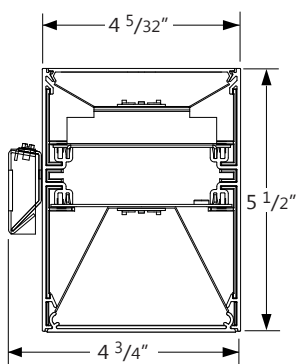

PERFORMANCE PER LINEAR FOOT AT 3500K

NOMINAL LUMEN OUTPUT		INPUT WATTS*	EFFICACY
UPLIGHT	DOWNLIGHT		
400 lm/ft	400 lm/ft	6.7 W/ft	124 lm/W
400 lm/ft	500 lm/ft	7.6 W/ft	123 lm/W
400 lm/ft	750 lm/ft	9.7 W/ft	124 lm/W
500 lm/ft	400 lm/ft	7.6 W/ft	124 lm/W
500 lm/ft	500 lm/ft	8.4 W/ft	124 lm/W
500 lm/ft	750 lm/ft	10.5 W/ft	122 lm/W
750 lm/ft	400 lm/ft	9.7 W/ft	125 lm/W
750 lm/ft	500 lm/ft	10.5 W/ft	124 lm/W
750 lm/ft	750 lm/ft	12.6 W/ft	124 lm/W

Please consult factory for custom lumen output and wattage.



Ordering Guide

BBWDILED		NOM. LUMENS/FT UPLIGHT		NOM. LUMENS/FT DOWNLIGHT		CRI		COLOR TEMP.		SO	
PRODUCT ID										SHIELDING	
BBWDILED	Wall Direct/Indirect LED	400	400 lm/ft uplight	400	400 lm/ft downlight	80	80 CRI	27	2700 K	SO	spotless lens
		1000	1000 lm/ft uplight	1000	1000 lm/ft downlight	90	90 CRI	30	3000 K		
		For fixtures shorter than 4', all driver options may not be available for all lumen packages. Please consult Axis.		For fixtures shorter than 4', all driver options may not be available for all lumen packages. Please consult Axis.							

LENGTH (FT)	MR (OPTIONAL)		FINISH		VOLTAGE		DRIVER	
2 2'	M16(#)	MR16 halogen lamp - Line voltage (by other) ⁽¹⁾	AP	aluminum paint	120	120 V	DP	dimming (0-10V) 1%
3 3'	M16LED(#)	MR16 LED lamp - Line voltage (by other) ⁽¹⁾	W	white	277	277 V	LT	Lutron ⁽³⁾
4 4'	M16LEDB(#)	MR16 LED lamp - Dimmable (provided) ⁽²⁾	BLK	black	347	347 V	BI	bi-level dimming
5 5'			C	custom	UNV	universal	O	other ⁽⁴⁾
6 6'								
8 8'								
12 12'								
S#	system run							
		(1) Specify quantity; Line wattage only; Separate circuits included (2) Consult factory; See page 3 for more details. MR16 constant current for 0-10V & DALI only						(3) Specify system (4) Please consult factory; see page 2

CIRCUITS	BATTERY (OPTIONAL)	OTHER (OPTIONAL)	IC CONTROLS (OPTIONAL)	CUSTOM (OPTIONAL)
1 1 circuit 2 2 circuits +E(#) emergency circuit ⁽⁵⁾ +NL(#) night light circuit ⁽⁵⁾ +GTD(#) generator transfer device ⁽⁵⁾ +M MR	B# battery pack 4' sections	F fuse ⁽⁶⁾ D dust cover	DS# daylight sensor OS# occupancy sensor DOS# daylight & occupancy sensor EN# Enlighted integral ⁽⁷⁾ ENR# Enlighted remote ⁽⁷⁾ WC# wireless control dimming	C custom
(5) Specify quantity	Not available with 347V Please consult factory	(6) Requires 120V or 277V	(7) Please consult factory Specify quantity. Requires 8" blank. See integrated controls guide for more details.	Please specify

● SPECIFICATIONS

CONSTRUCTION

Housing	Extruded aluminum (0.075" nominal) up to 70% recycled content
End Cap	Sheet steel (18 gauge)
Interior Brackets	Die formed sheet steel (18 gauge)
Reflectors	White powder coated sheet steel (22 gauge)
Blank	Extruded aluminum (0.075" nominal)
Lens	Spotless frosted acrylic lens
Wall Mount Bracket	Die formed sheet steel (16 gauge)

● ELECTRICAL

Lutron driver*	LDE1 - EcoSystem H-Series (1%) LDE5 - EcoSystem 5-Series (5%) LTE - Hi-Lume® A-series 2Wires Forward Phase (1%) *Consult factory
Other drivers	DALI - Digital Addressable Lighting Interface DMX - Digital Multiplex LV - line voltage - Advance Mark 10 Xitanium SR - For wireless sensor
Emergency	Integral emergency battery pack or emergency circuit optional.
Input Voltage	120V, 277V, 347V, UNV.

i Incorporating these components may have limitations or affect the length of the luminaire. Please contact factory for more details.

● WARRANTY

Axis Lighting will warrant defective LEDs, boards, and drivers for 5 years from date of purchase. Warranty is valid if luminaire is installed and used according to specifications. If defective, Axis will send replacement boards or drivers at no cost along with detailed replacement instructions and instructions on how to return defective components to Axis.

● APPROVALS

Certified to UL and CSA standards
Meets NYC requirements
Suitable for damp locations.



● SYSTEM (S#)

BEAM4 LED linear systems, with the use of a strong profile, allow for a nearly hair thin connection system of continuous runs. Lengths of 4', 8', 12' as well as custom lengths are available. Runs of BEAM4 LED that are greater than 12" in length are designated as systems (S#). This means that the run is comprised of a combination of 4', 8' and/or 12' sections to be assembled on site using our joining system. For more information on systems and joining, please refer to the BEAM4 LED installation sheets available for download at www.axislighting.com.

● WEIGHT

Wall Direct/Indirect 4 ft	14.5 lbs / 6.6 kg
Wall Direct/Indirect 8 ft	29.0 lbs / 13.2 kg
Wall Direct/Indirect 12 ft	43.5 lbs / 19.7 kg

● JOINERS

In order to allow very long runs of BEAM4 LED luminaires, Axis has developed a number of different joining systems. Special care has been taken to maximize the performance of the joiner for each BEAM option.

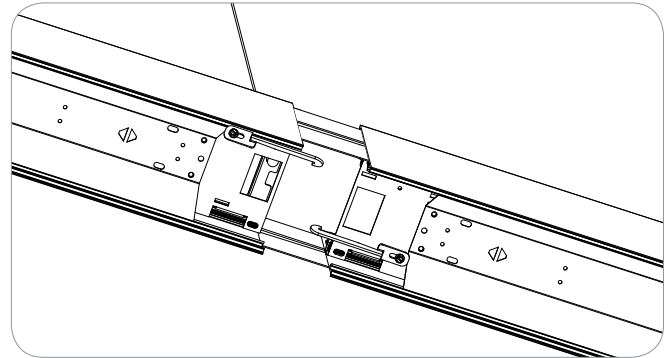

NOTE: Mount each system segment individually. Do not assemble system prior to mounting.

● CORNERS

Unlit Corners - BEAM4 LED features a multitude of layout patterns with the use of a number of corners, 90° corner, T or X junctions.

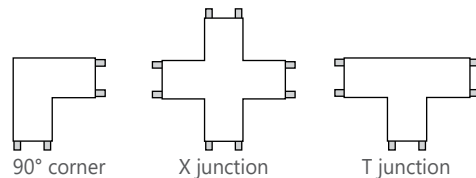
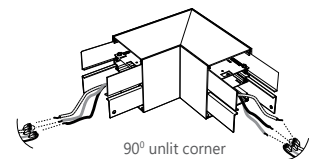

Lit Corners - In addition Axis offers Lit 90° corners including ceiling to ceiling, wall to ceiling and ceiling to wall.

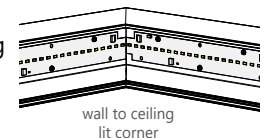

i For custom corner angles, please consult factory. Specifications sheets for all corners are available at: www.axislighting.com

● OPTICS

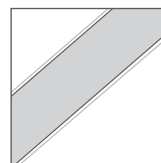

SO spotless lens

SPOTLESS LENS

Frosted acrylic snap-in lens with micro lens

● FINISHES

Powder coated and custom finishes are also available.

● HORIZONTAL MOUNTING DETAILS

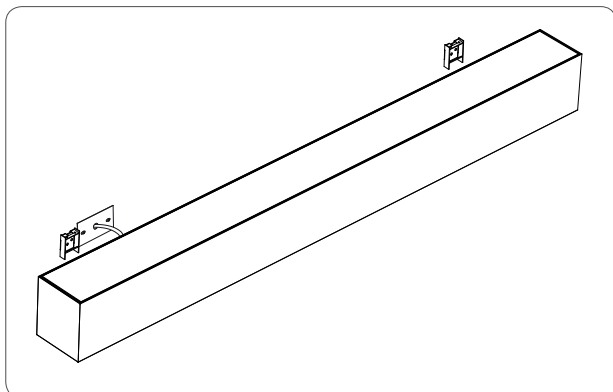

MOUNTING BRACKETS

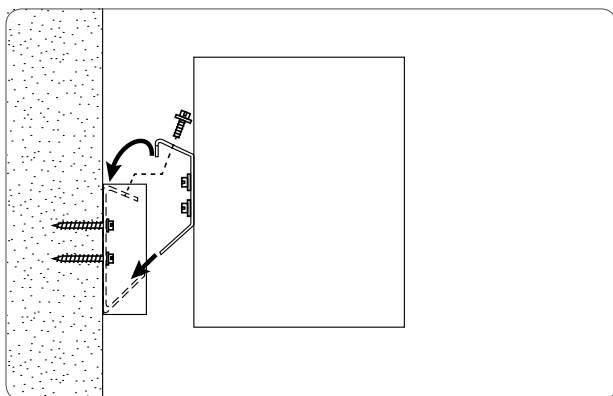

SIDE VIEW

● OTHER MOUNTING OPTIONS

BEAM4 LED is available with recessed, pendant, surface and recessed vertical mounted options.

i Specification sheets and installation sheets for all mountings for BEAM4 LED luminaires are available for download at www.axislighting.com

● LED SYSTEM

CRI	Minimum 80 or 90 color rendering index
CCT	Choice of 2700K, 3000K, 3500K and 4000K color temperature with a great color consistency (within 3.5-step MacAdam ellipse).
LED life	Minimum 50,000h with 70% of lumen maintenance in 25°C ambient temperature, in compliance with IES LM-80 testing measurements.
Thermal management	Aluminium housing acting as the heat sink to maximize life.

● MR16 LED LAMPS

Blank	Extruded aluminum (0.075" nominal)
MR16 Halogens	Adjustable halogen lamp 35W / 50W (by others) - Line voltage dimming only
MR16 LED	Adjustable LED lamp (provided)- Line voltage dimming only
MR16 LEDB	Constant current LED lamp (provided)- Dimmable by control system for 0-10V DALI only
Quantity	For every 4' section, there may be up to a maximum of 4 x MR16 LED lamps.

Spacing

Each MR16 LED lamp is placed centered on a blank section 9" in length.

For a series of MR16's within a given section length, they will be spaced evenly on a longer blank section.

The directed light of MR16 LED lamps are fixed downward.

Custom spacing may be available on special request.

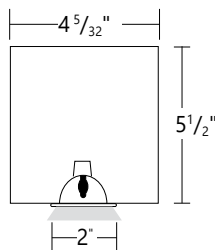

Between sections

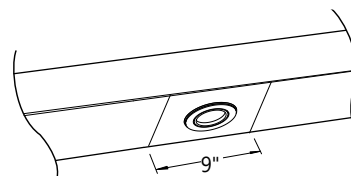

At luminaire ends

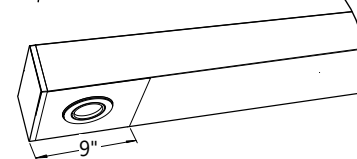

Several in a long blank section

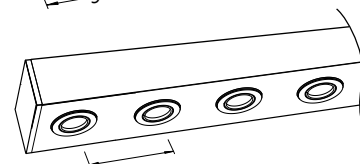

Base Type	GU 5.3
Beam Angle	40 nominal degrees
Input Watts	6W
Nominal Lumens	300 lumens
Efficacy	50 lumens per watt
Color Rendering Index (CRI)	85
Center Beam Candle Power (CBCP)	584 candelas
Life	25,000 hours at L ₇₀
Correlated color temperature (CCT)	2700K

i More options are available upon request. Please consult factory.

PHOTOMETRIC DATA

Uplight 50%
400 lm/ft
Downlight 50%
400 lm/ft

PHOTOMETRIC CURVE

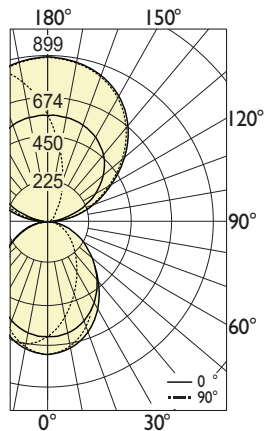

Total Lumens: 3322 lm (for 4 feet)

Luminaire Lumens: 400 lm/ft up
400 lm/ft down

Input Watts: 6.7 W/ft
Efficacy: 124 lm/W

IES FILE: BBWDILED-400-400-80-35-ASO.IES
TESTED ACCORDING TO IES LM-79-2008

CANDELA DISTRIBUTION

Vertical Angle	Horizontal Angles				
	0	22.5	45	67.5	90
0	636	636	636	636	636
5	590	595	605	619	636
15	480	492	521	561	610
25	370	386	425	483	552
35	276	293	333	395	471
45	203	217	251	306	375
55	146	156	181	223	276
65	98	104	121	148	184
75	56	59	68	83	103
85	19	21	25	30	36
90	3	4	7	9	11
95	7	10	9	8	16
105	13	13	15	32	111
115	18	23	33	73	239
125	34	40	58	136	352
135	55	61	103	215	443
145	88	121	180	301	511
155	181	217	279	390	556
165	313	346	396	476	581
175	489	504	525	554	592
180	591	591	591	591	591

ZONAL LUMENS

Zone	Lumens
0	
0-10	60
10-20	170
20-30	249
30-40	284
40-50	277
50-60	235
60-70	173
70-80	105
80-90	41
90	0
90-100	13
100-110	82
110-120	191
120-130	261
130-140	297
140-150	293
150-160	247
160-170	163
170-180	56
180	0

LUMINANCE DATA (cd/m²)

Vertical Angle	Horizontal Angles		
	0	45	90
45	26184	32359	48246
55	23135	28781	43832
65	21215	25982	39574
75	19589	23979	36378
85	20345	26125	38111

Uplight 40%
400 lm/ft
Downlight 60%
500 lm/ft

PHOTOMETRIC CURVE

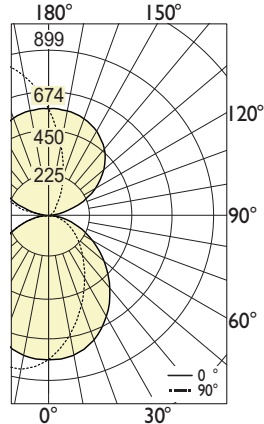

Total Lumens: 3721 lm (for 4 feet)

Luminaire Lumens: 400 lm/ft up
500 lm/ft down

Input Watts: 7.6 W/ft
Efficacy: 123 lm/W

IES FILE: BBWDILED-400-500-80-35-ASO.IES
TESTED ACCORDING TO IES LM-79-2008

CANDELA DISTRIBUTION

Vertical Angle	Horizontal Angles				
	0	22.5	45	67.5	90
0	795	795	795	795	795
5	738	743	756	773	794
15	600	616	651	702	762
25	462	483	531	604	691
35	346	366	416	494	589
45	254	271	314	383	468
55	182	194	227	279	345
65	123	130	151	186	230
75	70	74	85	104	129
85	24	26	31	38	46
90	4	5	8	11	14
95	7	10	9	8	16
105	13	13	15	32	111
115	18	23	33	73	239
125	34	40	58	136	352
135	55	61	103	215	443
145	88	121	180	301	511
155	181	217	279	390	556
165	313	346	396	476	581
175	489	504	525	554	592
180	591	591	591	591	591

ZONAL LUMENS

Zone	Lumens
0	
0-10	75
10-20	213
20-30	311
30-40	355
40-50	346
50-60	294
60-70	217
70-80	131
80-90	51
90	
90-100	19
100-110	103
110-120	217
120-130	285
130-140	317
140-150	308
150-160	256
160-170	166
170-180	57
180	

LUMINANCE DATA (cd/m²)

Vertical Angle	Horizontal Angles		
	0	45	90
45	32729	40448	60308
55	28919	35977	54791
65	26519	32478	49468
75	24485	29974	45473
85	25431	32655	47640

i All IES files for other lamping are available for download at: www.axislighting.com

PHOTOMETRIC DATA

Uplight 50%
400 lm/ft
Downlight 50%
750 lm/ft

PHOTOMETRIC CURVE

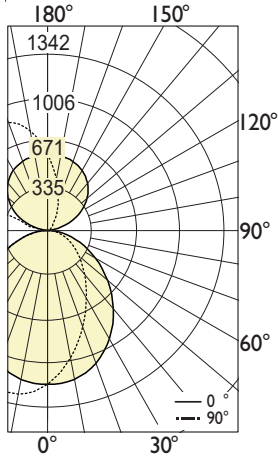

Total Lumens: 1150 lm (for 4 feet)
Luminaire Lumens: 400 lm/ft up
750 lm/ft down
Input Watts: 9.7 W/ft
Efficacy: 122 lm/W

IES FILE: BBWDILED-400-750-80-35-ASO.IES
 TESTED ACCORDING TO IES LM-79-2008

CANDELA DISTRIBUTION

Vertical Angle	Horizontal Angles				
	0	22.5	45	67.5	90
0	1191	1191	1191	1191	1191
5	1105	1114	1132	1158	1190
15	899	922	975	1051	1142
25	692	723	796	905	1034
35	518	548	623	740	882
45	381	406	471	574	702
55	273	291	340	418	517
65	184	195	226	278	344
75	104	111	128	155	194
85	36	40	47	57	68
90	6	8	12	17	21
95	7	10	9	8	16
105	13	13	15	32	111
115	18	23	33	73	239
125	34	40	58	136	352
135	55	61	103	215	443
145	88	121	180	301	511
155	181	217	279	390	556
165	313	346	396	476	581
175	489	504	525	554	592
180	591	591	591	591	591

ZONAL LUMENS

Zone	Lumens
0	
0-10	113
10-20	319
20-30	466
30-40	532
40-50	518
50-60	440
60-70	325
70-80	196
80-90	77
90	0
90-100	20
100-110	103
110-120	217
120-130	285
130-140	317
140-150	308
150-160	256
160-170	166
170-180	57
180	0

LUMINANCE DATA (cd/m²)

Vertical Angle	Horizontal Angles		
	0	45	90
45	49029	60591	90341
55	43321	53893	82076
65	39725	48652	74102
75	36679	44901	68119
85	38096	48917	71364

Uplight 40%
500 lm/ft
Downlight 60%
400 lm/ft

PHOTOMETRIC CURVE

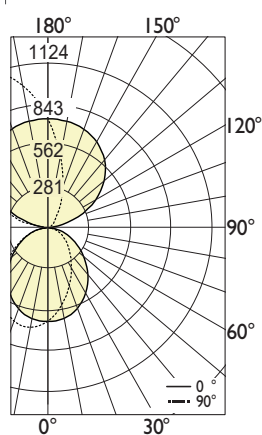

Total Lumens: 3754 lm (for 4 feet)
Luminaire Lumens: 500 lm/ft up
400 lm/ft down
Input Watts: 7.6 W/ft
Efficacy: 124 lm/W

IES FILE: BBWDILED-500-400-80-35-ASO.IES
 TESTED ACCORDING TO IES LM-79-2008

CANDELA DISTRIBUTION

Vertical Angle	Horizontal Angles				
	0	22.5	45	67.5	90
0	636	636	636	636	636
5	590	595	605	619	636
15	480	492	521	561	610
25	370	386	425	483	552
35	276	293	333	395	471
45	203	217	251	306	375
55	146	156	181	223	276
65	98	104	121	148	184
75	56	59	68	83	103
85	19	21	25	30	36
90	4	5	8	11	14
95	9	13	11	10	19
105	16	16	19	40	139
115	22	28	41	91	299
125	42	50	73	170	440
135	69	76	129	269	554
145	110	152	225	376	638
155	226	272	348	488	695
165	391	433	495	595	726
175	611	631	656	693	740
180	739	739	739	739	739

ZONAL LUMENS

Zone	Lumens
0	
0-10	60
10-20	170
20-30	249
30-40	284
40-50	277
50-60	235
60-70	173
70-80	105
80-90	41
90	0
90-100	23
100-110	129
110-120	272
120-130	356
130-140	396
140-150	385
150-160	320
160-170	208
170-180	71
180	0

LUMINANCE DATA (cd/m²)

Vertical Angle	Horizontal Angles		
	0	45	90
45	26184	32359	48246
55	23135	28781	43832
65	21215	25982	39574
75	19589	23979	36378
85	20345	26125	38111

i All IES files for other lamping are available for download at: www.axislighting.com

PHOTOMETRIC DATA

Uplight 50%
500 lm/ft
Downlight 50%
500 lm/ft

PHOTOMETRIC CURVE

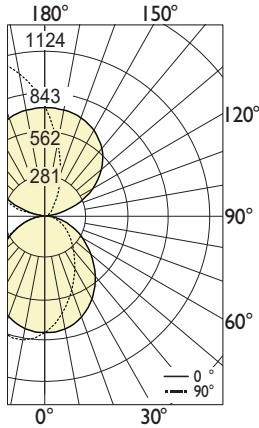

Total Lumens: 4152 lm (for 4 feet)
Luminaire Lumens: 500 lm/ft up
500 lm/ft down
Input Watts: 8.4 W/ft
Efficacy: 124 lm/W

IES FILE: BBWDILED-500-500-80-35-ASO.IES
 TESTED ACCORDING TO IES LM-79-2008

CANDELA DISTRIBUTION

Vertical Angle	Horizontal Angles				
	0	22.5	45	67.5	90
0	795	795	795	795	795
5	738	743	756	773	794
15	600	616	651	702	762
25	462	483	531	604	691
35	346	366	416	494	589
45	254	271	314	383	468
55	182	194	227	279	345
65	123	130	151	186	230
75	70	74	85	104	129
85	24	26	31	38	46
90	4	5	8	11	14
95	9	13	11	10	19
105	16	16	19	40	139
115	22	28	41	91	299
125	42	50	73	170	440
135	69	76	129	269	554
145	110	152	225	376	638
155	226	272	348	488	695
165	391	433	495	595	726
175	611	631	656	693	740
180	739	739	739	739	739

ZONAL LUMENS

Zone	Lumens
0	0
0-10	75
10-20	213
20-30	311
30-40	355
40-50	346
50-60	294
60-70	217
70-80	131
80-90	51
90	0
90-100	23
100-110	129
110-120	272
120-130	356
130-140	396
140-150	385
150-160	320
160-170	208
170-180	71
180	0

LUMINANCE DATA (cd/m²)

Vertical Angle	Horizontal Angles		
	0	45	90
45	32729	40448	60308
55	28919	35977	54791
65	26519	32478	49468
75	24485	29974	45473
85	25431	32655	47640

Uplight 40%
500 lm/ft
Downlight 60%
750 lm/ft

PHOTOMETRIC CURVE

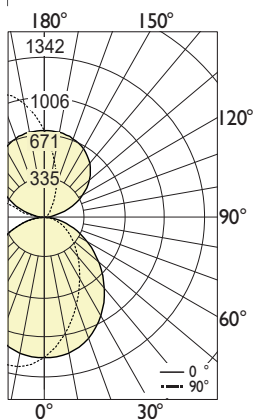

Total Lumens: 5144 lm (for 4 feet)
Luminaire Lumens: 500 lm/ft up
750 lm/ft down
Input Watts: 10.5 W/ft
Efficacy: 122 lm/W

IES FILE: BBWDILED-500-750-80-35-ASO.IES
 TESTED ACCORDING TO IES LM-79-2008

CANDELA DISTRIBUTION

Vertical Angle	Horizontal Angles				
	0	22.5	45	67.5	90
0	1191	1191	1191	1191	1191
5	1105	1114	1132	1158	1190
15	899	922	975	1051	1142
25	692	723	796	905	1034
35	518	548	623	740	882
45	381	406	471	574	702
55	273	291	340	418	517
65	184	195	226	278	344
75	104	111	128	155	194
85	36	40	47	57	68
90	4	5	8	11	14
95	9	13	11	10	19
105	16	16	19	40	139
115	22	28	41	91	299
125	42	50	73	170	440
135	69	76	129	269	554
145	110	152	225	376	638
155	226	272	348	488	695
165	391	433	495	595	726
175	611	631	656	693	740
180	739	739	739	739	739

ZONAL LUMENS

Zone	Lumens
0	0
0-10	113
10-20	319
20-30	466
30-40	532
40-50	518
50-60	440
60-70	325
70-80	196
80-90	76
90	0
90-100	23
100-110	129
110-120	272
120-130	356
130-140	396
140-150	385
150-160	320
160-170	208
170-180	71
180	0

LUMINANCE DATA (cd/m²)

Vertical Angle	Horizontal Angles		
	0	45	90
45	49029	60591	90341
55	43321	53893	82076
65	39725	48652	74102
75	36679	44901	68119
85	38096	48917	71364

i All IES files for other lamping are available for download at: www.axislighting.com

● PHOTOMETRIC DATA

Uplight 60%
750 lm/ft
Downlight 40%
400 lm/ft

PHOTOMETRIC CURVE

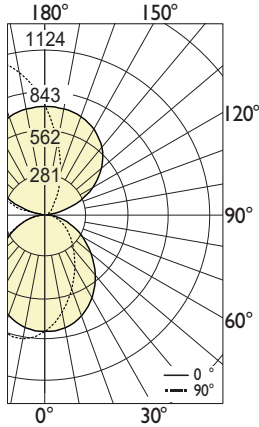

Total Lumens: 4831 lm (for 4 feet)
Luminaire Lumens: 750 lm/ft up
400 lm/ft down
Input Watts: 9.7 W/ft
Efficacy: 125 lm/W

IES FILE: BBWDILED-750-400-80-35-ASO.IES
 TESTED ACCORDING TO IES LM-79-2008

CANDELA DISTRIBUTION

Vertical Angle	Horizontal Angles				
	0	22.5	45	67.5	90
0	636	636	636	636	636
5	590	595	605	619	636
15	480	492	521	561	610
25	370	386	425	483	552
35	276	293	333	395	471
45	203	217	251	306	375
55	146	156	181	223	276
65	98	104	121	148	184
75	56	59	68	83	103
85	19	21	25	30	36
90	6	8	12	17	21
95	14	20	17	15	29
105	23	24	28	60	208
115	33	42	61	136	448
125	63	75	109	255	659
135	103	114	193	403	830
145	165	227	338	564	956
155	338	407	522	731	1040
165	586	648	742	891	1087
175	915	945	983	1038	1108
180	1107	1107	1107	1107	1107

ZONAL LUMENS

Zone	Lumens
0	
0-10	60
10-20	170
20-30	249
30-40	284
40-50	277
50-60	235
60-70	173
70-80	105
80-90	42
90	0
90-100	35
100-110	193
110-120	407
120-130	534
130-140	593
140-150	576
150-160	480
160-170	311
170-180	106
180	0

LUMINANCE DATA (cd/m²)

Vertical Angle	Horizontal Angles		
	0	45	90
45	26184	32359	48246
55	23135	28781	43832
65	21215	25982	39574
75	19589	23979	36378
85	20345	26125	38111

Uplight 40%
750 lm/ft
Downlight 60%
500 lm/ft

PHOTOMETRIC CURVE

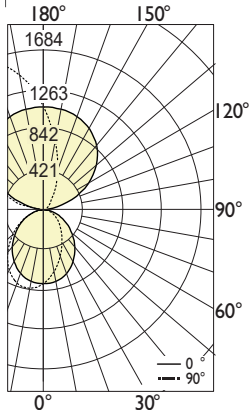

Total Lumens: 5229 lm (for 4 feet)
Luminaire Lumens: 750 lm/ft up
500 lm/ft down
Input Watts: 10.5 W/ft
Efficacy: 124 lm/W

IES FILE: BBWDILED-750-500-80-35-ASO.IES
 TESTED ACCORDING TO IES LM-79-2008

CANDELA DISTRIBUTION

Vertical Angle	Horizontal Angles				
	0	22.5	45	67.5	90
0	795	795	795	795	795
5	738	743	756	773	794
15	600	616	651	702	762
25	462	483	531	604	691
35	346	366	416	494	589
45	254	271	314	383	468
55	182	194	227	279	345
65	123	130	151	186	230
75	70	74	85	104	129
85	24	26	31	38	46
90	6	8	12	17	21
95	14	20	17	15	29
105	23	24	28	60	208
115	33	42	61	136	448
125	63	75	109	255	659
135	103	114	193	403	830
145	165	227	338	564	956
155	338	407	522	731	1040
165	586	648	742	891	1087
175	915	945	983	1038	1108
180	1107	1107	1107	1107	1107

ZONAL LUMENS

Zone	Lumens
0	
0-10	75
10-20	213
20-30	311
30-40	355
40-50	346
50-60	294
60-70	217
70-80	131
80-90	52
90	0
90-100	35
100-110	193
110-120	407
120-130	534
130-140	593
140-150	576
150-160	480
160-170	311
170-180	106
180	0

LUMINANCE DATA (cd/m²)

Vertical Angle	Horizontal Angles		
	0	45	90
45	32729	40448	60308
55	28919	35977	54791
65	26519	32478	49468
75	24485	29974	45473
85	25431	32655	47640

i All IES files for other lamping are available for download at: www.axislighting.com

PHOTOMETRIC DATA

Uplight 50%
750 lm/ft
 Downlight 50%
750 lm/ft

PHOTOMETRIC CURVE

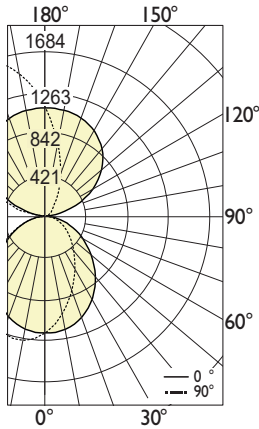

Total Lumens: 6220 lm (for 4 feet)
Luminaire Lumens: 750 lm/ft up
750 lm/ft down
Input Watts: 12.6 W/ft
Efficacy: 124 lm/W

IES FILE: BBWDILED-750-750-80-35-ASO.IES
 TESTED ACCORDING TO IES LM-79-2008

CANDELA DISTRIBUTION

Vertical Angle	Horizontal Angles				
	0	22.5	45	67.5	90
0	1191	1191	1191	1191	1191
5	1105	1114	1132	1158	1190
15	899	922	975	1051	1142
25	692	723	796	905	1034
35	518	548	623	740	882
45	381	406	471	574	702
55	273	291	340	418	517
65	184	195	226	278	344
75	104	111	128	155	194
85	36	40	47	57	68
90	6	8	12	17	21
95	14	20	17	15	29
105	23	24	28	60	208
115	33	42	61	136	448
125	63	75	109	255	659
135	103	114	193	403	830
145	165	227	338	564	956
155	338	407	522	731	1040
165	586	648	742	891	1087
175	915	945	983	1038	1108
180	1107	1107	1107	1107	1107

ZONAL LUMENS

Zone	Lumens
0	
0-10	113
10-20	319
20-30	466
30-40	532
40-50	518
50-60	440
60-70	325
70-80	196
80-90	77
90	0
90-100	35
100-110	193
110-120	407
120-130	534
130-140	593
140-150	576
150-160	480
160-170	311
170-180	106
180	0

LUMINANCE DATA (cd/m²)

Vertical Angle	Horizontal Angles		
	0	45	90
45	49029	60591	90341
55	43321	53893	82076
65	39725	48652	74102
75	36679	44901	68119
85	38096	48917	71364