



Project _____

Type _____

Notes _____

PERFORMANCE PER LINEAR FOOT AT 3500K

NOMINAL LUMEN OUTPUT	INPUT WATTS	EFFICACY
500 lm/ft	5.32 W/ft	94 lm/W
600 lm/ft	5.62 W/ft	112 lm/W
800 lm/ft	7.62 W/ft	105 lm/W
1000 lm/ft	9.80 W/ft	102 lm/W

Please consult factory for custom lumen output and wattage.

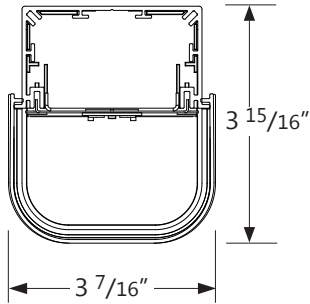

Ordering Guide

ARSLED				S			
PRODUCT ID	NOM.LUMENS/FT		CRI	COLOR TEMP.	SHIELDING	LENGTH/FT	FINISH
ARSLED AIR surface LED	500	500 lm/ft - Minimum	80	27	S	2	AP
	1000	1000 lm/ft - Maximum	90	30		3	
				35		4	W
				40		6	BLK
						8	C
						12	
						S#	
Outputs between listed min and max are available. Consult factory for outputs outside of the listed range.							

VOLTAGE	DRIVER	CIRCUITS	MOUNTING/SUSPENSION	BATTERY (OPTIONAL)
120 120 V	DP dimming (0-10V) 1%	1 1 circuit	SB9 surface TB/TG 9/16	B# battery pack 4' sections
277 277 V	D dimming (0-10V) 5% 347V standard (2)	2 2 circuits	SB15 surface TB/TG 15/16	
347 347 V (1)	LT Lutron (3)	+E(#) emergency circuit	SBS surface screw slot t-bar	
UNV universal	BI bi-level dimming	+NL(#) night light circuit	S surface drywall ceiling	
	O other (4)	+GTD(#) generator transfer device	SC surface solid ceiling	
(1) D dimming (0-10V) 5% standard	(2) For 347V only (3) Specify system (4) Please consult factory; see page 2	Specify quantity		Specify quantity Requires 120V or 277V Please consult factory

IC CONTROLS (OPTIONAL)	OTHER (OPTIONAL)	CUSTOM (OPTIONAL)
DS# daylight sensor	F fuse	C custom
OS# occupancy sensor		
DOS# daylight & occupancy sensor		
EN# Enlighted integral (5)		
ENR# Enlighted remote (6)		
WC# wireless control dimming		
(5) For flush option only; Please consult factory (6) Please consult factory Specify quantity. Requires 8" blank See integrated controls guide for more details.	Requires 120V or 277V	Please specify

● LIGHT DISTRIBUTION



semi-direct

● MOUNTING DETAILS

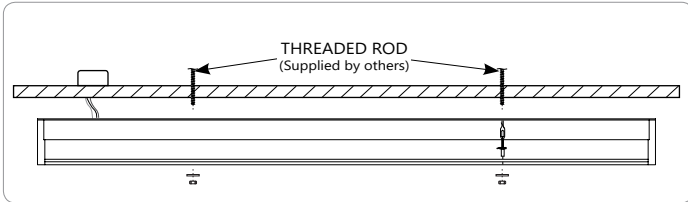

S SURFACE MOUNT DRYWALL CEILING

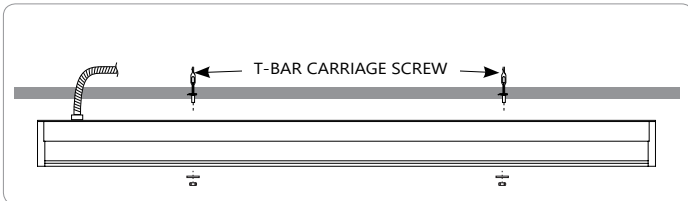

SB SB9 SB15 SBS SURFACE MOUNT ON GRID T-BAR CEILING

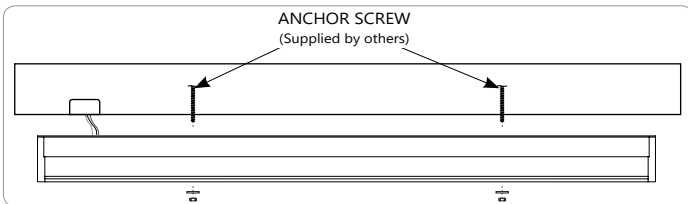

SC SURFACE MOUNT SOLID CEILING

i Installation sheets for all mounting options are available at www.axislighting.com

● OTHER MOUNTING OPTIONS

AIR LED is also available in pendant and wall mounted options.

i Specification sheets for all mounting options are available for download at www.axislighting.com

● WEIGHT

AIR LED 4 ft	9.5 lbs / 4.3 kg
AIR LED 8 ft	19 lbs / 8.6 kg
AIR LED 12 ft	28.5 lbs / 12.9 kg

● FINISHES

Powder coated and custom finishes are also available.

● APPROVALS

Certified to UL and CSA standards 
Suitable for damp locations.

● OPTICAL SYSTEM

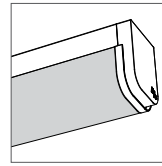

S satin lens

PMMA satin finish (0.060" nominal)

AIR LED delivers softly diffused and ample illumination with a Satin lens which provides maximum glare reduction and light uniformity.

● SYSTEMS (S#)

Runs of AIR LED that are greater than 12ft in length are designated as systems (S#). The run is comprised of a combination of sections to be assembled on site using our joining system. For more information on systems and joining, please refer to the AIR LED installation sheets available for download at www.axislighting.com

● SPECIFICATIONS

CONSTRUCTION

Housing	Extruded aluminium (0.070" nominal) Up to 70% recycled content
End Cap	Die cast zinc (0.080" nominal)
Joiners	Die cast zinc (0.065" nominal)
Interior Brackets	Die formed sheet steel (18 gauge)
Reflectors	Die formed sheet steel (22 gauge)
Lens joiners	Die cast zinc (0.125" nominal)
Satin lens	Acrylic satin finish (0.060" nominal)

● ELECTRICAL

Lutron driver*	L3D - Hi-Lume A-Series EcoSystem 3-Wire Control (1%) LDE1 - EcoSystem H-Series (1%) LDE5 - EcoSystem 5-Series (5%) LTE - Hi-Lume® A-series 2Wires Forward Phase (1%) <small>*Consult factory</small>
Other drivers	DALI - Digital Addressable Lighting Interface DMX - Digital Multiplex LV - line voltage - Advance Mark 10 Xtanium SR - For wireless sensor
Emergency	Integral emergency battery pack or emergency circuit optional.
Input Voltage	120V, 277V, 347V, UNV.

i Incorporating these components may have limitations or affect the length of the luminaire. Please contact factory for more details.

● LED SYSTEM

CRI	Minimum 80 or 90 color rendering index
CCT	Choice of 2700K, 3000K, 3500K and 4000K color temperature with a great color consistency (within 3.5-step MacAdam ellipse).
LED life	Minimum 50,000h with 70% of lumen maintenance in 25°C ambient temperature, in compliance with IES LM-80 testing measurements.
Thermal management	Aluminium housing acting as the heat sink to maximize life.

● PHOTOMETRIC DATA

500 lm/ft

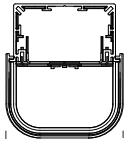

PHOTOMETRIC CURVE

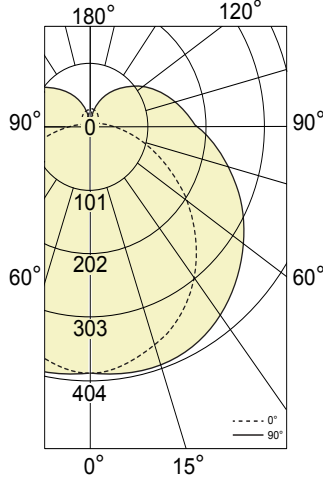

Lumen/ft down: 500 lm/ft
 Total Lumens: 2000 lm (for 4ft)
 Input Watts: 21.3 W
 Efficacy: 94 lm/W

IES FILE: ARSLED-500-80-35-4.IES
 TESTED ACCORDING TO IES LM-79-2008

CANDELA DISTRIBUTION

Vertical Angle	Horizontal Angles				
	0	22.5	45	67.5	90
0	393	393	393	393	393
5	389	393	394	398	399
15	374	385	394	401	404
25	345	361	379	392	398
35	304	326	353	372	380
45	254	284	319	346	356
55	198	234	279	314	325
65	137	180	235	276	289
75	75	126	188	233	247
85	19	79	144	190	204
90	1	61	126	172	186
95	0	54	116	160	174
105	0	44	100	141	153
115	0	37	85	120	131
125	0	31	70	100	109
135	0	23	55	78	86
145	0	17	38	58	63
155	0	11	24	36	42
165	0	6	13	17	22
175	0	2	3	4	2
180	0	0	0	0	0

ZONAL LUMENS

Zone	Lumens
0	
0-10	37.67
10-20	110.78
20-30	173.41
30-40	218.35
40-50	242.07
50-60	243.49
60-70	223.88
70-80	187.68
80-90	144.16
90-100	114.16
100-110	95.67
110-120	76.43
120-130	57.12
130-140	38.59
140-150	22.77
150-160	10.80
160-170	3.46
170-180	0.36

LUMINANCE DATA (cd/m²)

Vertical Angle	Horizontal Angles		
	0	45	90
45	3386	3497	3674
55	3221	3484	3746
65	2978	3523	3900
75	2582	3677	4194
85	1669	4214	4831

600 lm/ft

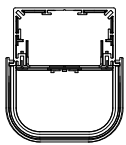

PHOTOMETRIC CURVE

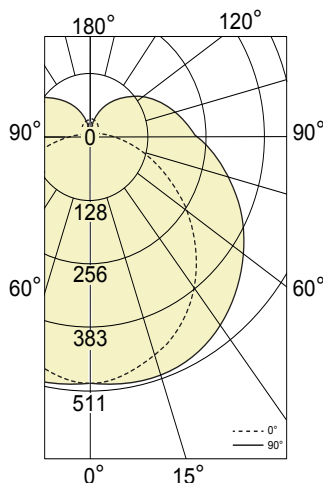

Lumen/ft down: 600 lm/ft
 Total Lumens: 2531 lm (for 4ft)
 Input Watts: 22.5W
 Efficacy: 112 lm/W

IES FILE: ARSLED-600-80-35-4.IES
 TESTED ACCORDING TO IES LM-79-2008

CANDELA DISTRIBUTION

Vertical Angle	Horizontal Angles				
	0	22.5	45	67.5	90
0	497	497	497	497	497
5	492	497	499	503	505
15	473	487	498	507	511
25	436	457	479	496	504
35	384	413	447	471	481
45	321	359	403	438	450
55	250	296	353	397	411
65	173	228	297	349	365
75	95	160	238	295	313
85	24	100	182	240	258
90	1	77	159	217	235
95	0	68	147	203	220
105	0	56	127	178	194
115	0	47	107	152	166
125	0	39	88	126	138
135	0	29	69	99	109
145	0	21	48	73	80
155	0	14	30	45	53
165	0	7	16	22	28
175	0	2	4	5	2
180	0	0	0	0	0

ZONAL LUMENS

Zone	Lumens
0	
0-10	47.65
10-20	140.13
20-30	219.37
30-40	276.21
40-50	306.22
50-60	308.02
60-70	283.21
70-80	237.41
80-90	182.36
90-100	144.42
100-110	121.02
110-120	96.68
120-130	72.26
130-140	48.82
140-150	28.80
150-160	13.67
160-170	4.37
170-180	0.45

LUMINANCE DATA (cd/m²)

Vertical Angle	Horizontal Angles		
	0	45	90
45	4284	4424	4647
55	4074	4408	4739
65	3768	4457	4934
75	3266	4651	5306
85	2112	5330	6112

i All IES files are available for download at: www.axislighting.com

● PHOTOMETRIC DATA

800 lm/ft

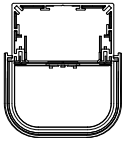

PHOTOMETRIC CURVE

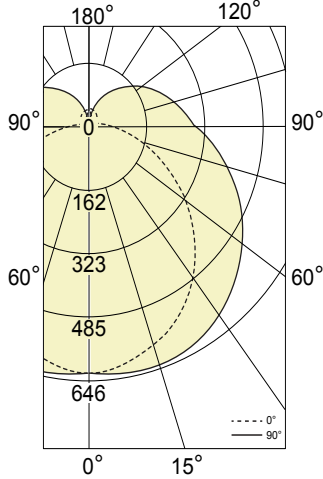

Lumen/ft down: 800 lm/ft
 Total Lumens: 3201 lm (for 4ft)
 Input Watts: 30.5W
 Efficacy: 105 lm/W

IES FILE: ARSLED-800-80-35-4.IES
 TESTED ACCORDING TO IES LM-79-2008

CANDELA DISTRIBUTION

Vertical Angle	Horizontal Angles				
	0	22.5	45	67.5	90
0	629	629	629	629	629
5	622	629	631	636	639
15	598	616	630	641	646
25	551	578	606	627	637
35	486	522	565	596	608
45	406	454	510	554	569
55	316	374	446	502	520
65	219	288	376	441	462
75	120	202	301	373	396
85	30	126	230	304	326
90	1	97	201	274	297
95	0	86	186	257	278
105	0	71	161	225	245
115	0	59	135	192	210
125	0	49	111	159	175
135	0	37	87	125	138
145	0	27	61	92	101
155	0	18	38	57	67
165	0	9	20	28	35
175	0	3	5	6	3
180	0	0	0	0	0

ZONAL LUMENS

Zone	Lumens
0	
0-10	60.32
10-20	177.32
20-30	277.49
30-40	349.37
40-50	387.21
50-60	389.33
60-70	358.20
70-80	300.16
80-90	229.98
90-100	182.43
100-110	152.94
110-120	122.19
120-130	91.48
130-140	61.96
140-150	36.52
150-160	17.37
160-170	5.60
170-180	0.60

LUMINANCE DATA (cd/m²)

Vertical Angle	Horizontal Angles		
	0	45	90
45	5418	5595	5878
55	5153	5575	5994
65	4765	5637	6240
75	4131	5883	6711
85	2671	6742	7730

1000 lm/ft

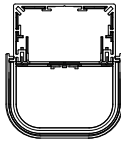

PHOTOMETRIC CURVE

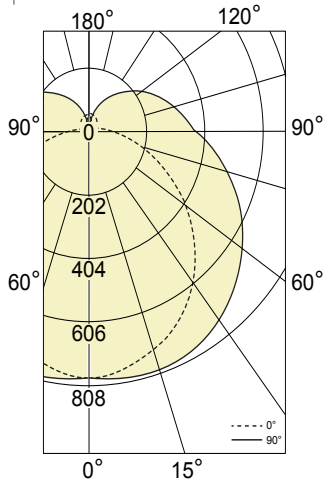

Lumen/ft down: 1000 lm/ft
 Total Lumens: 4002 lm (for 4ft)
 Input Watts: 39.2W
 Efficacy: 102 lm/W

IES FILE: ARSLED-1000-80-35-4.IES
 TESTED ACCORDING TO IES LM-79-2008

CANDELA DISTRIBUTION

Vertical Angle	Horizontal Angles				
	0	22.5	45	67.5	90
0	786	786	786	786	786
5	778	786	789	795	798
15	748	770	787	802	808
25	689	723	757	784	797
35	607	653	707	745	760
45	508	568	637	692	711
55	395	468	558	628	650
65	274	360	470	552	577
75	150	253	376	466	495
85	38	158	288	379	408
90	2	122	251	343	372
95	0	108	232	321	348
105	0	89	201	281	307
115	0	74	169	240	262
125	0	62	139	199	218
135	0	46	109	157	172
145	0	33	76	115	126
155	0	22	47	71	84
165	0	11	25	35	44
175	0	3	6	8	3
180	0	0	0	0	0

ZONAL LUMENS

Zone	Lumens
0	
0-10	75.33
10-20	221.56
20-30	346.83
30-40	436.70
40-50	484.14
50-60	486.99
60-70	447.77
70-80	375.36
80-90	288.31
90-100	228.33
100-110	191.33
110-120	152.85
120-130	114.24
130-140	77.18
140-150	45.54
150-160	21.61
160-170	6.92
170-180	0.71

LUMINANCE DATA (cd/m²)

Vertical Angle	Horizontal Angles		
	0	45	90
45	6773	6994	7348
55	6442	6968	7493
65	5957	7046	7800
75	5164	7353	8388
85	3338	8427	9663

i All IES files are available for download at: www.axislighting.com